



Operating Instructions and Parts Manual JMD-15/18/18PFN Mill/Drill Machine



(JMD-18 shown with optional CS-18 stand)

JET
427 New Sanford Road
LaVergne, Tennessee 37086
Ph.: 800-274-6848
www.jettools.com

Part No. M-350020
Revision G 06/2015
Copyright © 2015 JET

1.0 Warranty and Service

JET warrants every product it sells against manufacturers' defects. If one of our tools needs service or repair, please contact Technical Service by calling 1-800-274-6846, 8AM to 5PM CST, Monday through Friday.

Warranty Period

The general warranty lasts for the time period specified in the literature included with your product or on the official JET branded website.

- JET products carry a limited warranty which varies in duration based upon the product. (See chart below)
- Accessories carry a limited warranty of one year from the date of receipt.
- Consumable items are defined as expendable parts or accessories expected to become inoperable within a reasonable amount of use and are covered by a 90 day limited warranty against manufacturer's defects.

Who is Covered

This warranty covers only the initial purchaser of the product from the date of delivery.

What is Covered

This warranty covers any defects in workmanship or materials subject to the limitations stated below. This warranty does not cover failures due directly or indirectly to misuse, abuse, negligence or accidents, normal wear-and-tear, improper repair, alterations or lack of maintenance.

Warranty Limitations

Woodworking products with a Five Year Warranty that are used for commercial or industrial purposes default to a Two Year Warranty. Please contact Technical Service at 1-800-274-6846 for further clarification.

How to Get Technical Support

Please contact Technical Service by calling 1-800-274-6846. **Please note that you will be asked to provide proof of initial purchase when calling.** If a product requires further inspection, the Technical Service representative will explain and assist with any additional action needed. JET has Authorized Service Centers located throughout the United States. For the name of an Authorized Service Center in your area call 1-800-274-6846 or use the Service Center Locator on the JET website.

More Information

JET is constantly adding new products. For complete, up-to-date product information, check with your local distributor or visit the JET website.

How State Law Applies

This warranty gives you specific legal rights, subject to applicable state law.

Limitations on This Warranty

JET LIMITS ALL IMPLIED WARRANTIES TO THE PERIOD OF THE LIMITED WARRANTY FOR EACH PRODUCT. EXCEPT AS STATED HEREIN, ANY IMPLIED WARRANTIES OF MERCHANTABILITY AND FITNESS FOR A PARTICULAR PURPOSE ARE EXCLUDED. SOME STATES DO NOT ALLOW LIMITATIONS ON HOW LONG AN IMPLIED WARRANTY LASTS, SO THE ABOVE LIMITATION MAY NOT APPLY TO YOU.

JET SHALL IN NO EVENT BE LIABLE FOR DEATH, INJURIES TO PERSONS OR PROPERTY, OR FOR INCIDENTAL, CONTINGENT, SPECIAL, OR CONSEQUENTIAL DAMAGES ARISING FROM THE USE OF OUR PRODUCTS. SOME STATES DO NOT ALLOW THE EXCLUSION OR LIMITATION OF INCIDENTAL OR CONSEQUENTIAL DAMAGES, SO THE ABOVE LIMITATION OR EXCLUSION MAY NOT APPLY TO YOU.

JET sells through distributors only. The specifications listed in JET printed materials and on official JET website are given as general information and are not binding. JET reserves the right to effect at any time, without prior notice, those alterations to parts, fittings, and accessory equipment which they may deem necessary for any reason whatsoever. JET® branded products are not sold in Canada by JPW Industries, Inc.

Product Listing with Warranty Period

90 Days – Parts; Consumable items
1 Year – Motors; Machine Accessories
2 Year – Metalworking Machinery; Electric Hoists, Electric Hoist Accessories; Woodworking Machinery used for industrial or commercial purposes
5 Year – Woodworking Machinery
Limited Lifetime – JET Parallel clamps; VOLT Series Electric Hoists; Manual Hoists; Manual Hoist Accessories; Shop Tools; Warehouse & Dock products; Hand Tools; Air Tools

NOTE: JET is a division of JPW Industries, Inc. References in this document to JET also apply to JPW Industries, Inc., or any of its successors in interest to the JET brand.

2.0 Table of contents

Section	Page
1.0 Warranty and Service.....	2
2.0 Table of contents.....	3
3.0 Warnings.....	4
4.0 Specifications.....	5
5.0 Contents of Shipping Container.....	6
6.0 Unpacking and Clean-up.....	6
7.0 Assembly.....	7
8.0 Installation.....	7
9.0 Lubrication.....	8
10.0 Electrical Connections.....	8
11.0 Controls.....	9
12.0 Adjustments.....	10
12.1 Changing Spindle Speeds.....	10
12.2 Arbor Replacement.....	11
12.3 Gib Adjustment.....	12
12.4 Power Feed Operation (JMD-18PFN only).....	12
12.5 Adjusting Spindle Return Spring.....	12
13.0 Replacement Parts.....	13
13.1.1 JMD-15 Head Assembly – Exploded View.....	13
13.1.2 JMD-15 Head Assembly – Parts List.....	14
13.2.1 JMD-15 Table, Base, and Column Assembly – Exploded View.....	17
13.2.2 JMD-15 Table, Base, and Column Assembly – Parts List.....	17
13.3.1 JMD-18/18PFN Head Assembly – Exploded View.....	19
13.3.2 JMD-18/18PFN Head Assembly – Parts List.....	20
13.4.1 JMD-18 Table, Base, and Column Assembly – Exploded View.....	24
13.4.2 JMD-18 Table, Base, and Column Assembly – Parts List.....	24
13.5.1 JMD-18PFN Power Feed Assembly – Exploded View.....	27
13.5.2 JMD-18PFN Power Feed Assembly – Parts List.....	28
14.0 Electrical Connections.....	30
14.1 Wiring Diagram: JMD-15 Only.....	30
14.2 Wiring Diagram: JMD-18 Only.....	31



3.0 Warnings

Read and understand the entire contents of this manual before attempting set-up or operation of this mill/drill.

1. **This machine is designed and intended for use by properly trained and experienced personnel only.** If you are not familiar with the proper safe use of mill/drills, do not use this machine until proper training and knowledge has been obtained.
2. **Keep guards in place.** Safety guards must be kept in place and in working order.
3. **Remove adjusting keys and wrenches.** Before turning on machine, check to see that any adjusting wrenches are removed from the tool.
4. **Reduce the risk of unintentional starting.** Make sure switch is in the OFF position before plugging in the tool.
5. **Do not force tools.** Always use a tool at the rate for which it was designed.
6. **Use the right tool.** Do not force a tool or attachment to do a job for which it was not designed.
7. **Maintain tools with care.** Keep tools sharp and clean for best and safest performance. Follow instructions for lubrication and changing accessories.
8. **Always disconnect the tool from the power source before adjusting or servicing.**
9. **Check for damaged parts.** Check for alignment of moving parts, breakage of parts, mounting, and any other condition that may affect the tools operation. A guard or any part that is damaged should be repaired or replaced.
10. **Turn power off. Never leave a tool unattended.** Do not leave a tool until it comes to a complete stop.
11. **Keep work area clean.** Cluttered areas and benches invite accidents.
12. **Do not use in a dangerous environment.** Do not use power tools in damp or wet locations, or expose them to rain. Keep work area well lighted.
13. **Keep children and visitors away.** All visitors should be kept a safe distance from the work area.
14. **Make the workshop child proof.** Use padlocks, master switches, and remove starter keys.
15. **Wear proper apparel.** Loose clothing, gloves, neckties, rings, bracelets, or other jewelry may get caught in moving parts. Non-slip footwear is recommended. Wear protective hair covering to contain long hair. Do not wear any type of glove.
16. **Always use safety glasses.** Every day glasses only have impact resistant lenses; they are not safety glasses.
17. **Do not overreach.** Keep proper footing and balance at all times.
18. **Do not place hands near the cutterhead while the machine is operating.**
19. **Do not perform any set-up work while machine is operating.**
20. **Read and understand all warnings posted on the machine.**
21. **This manual is intended to familiarize you with the technical aspects of this mill/drill.** It is not, nor was it intended to be, a training manual.
22. **Failure to comply with all of these warnings may result in serious injury.**
23. **Some dust created** by power sanding, sawing, grinding, drilling and other construction activities contains chemicals known to cause cancer, birth defects or other reproductive harm. Some examples of these chemicals are:
 - Lead from lead based paint
 - crystalline silica from bricks and cement and other masonry products, and
 - arsenic and chromium from chemically-treated lumber.**Your risk from those exposures** varies, depending on how often you do this type of work. To reduce your exposure to these chemicals: work in a well ventilated area, and work with approved safety equipment, such as those dust masks that are specifically designed to filter out microscopic particles

4.0 Specifications

	JMD-15	JMD-18	JMD-18PFN
Stock No.	350017	350018	350020
Drilling Capacity	1"	1-1/4"	1-1/4"
Face Mill Capacity	2-1/2"	3"	3"
End Mill Capacity	1/2"	3/4"	3/4"
Swing	14-1/2"	15-7/8"	15-7/8"
Maximum Distance Spindle to Table	15"	18"	26"
Spindle Taper	R-8	R-8	R-8
Spindle Travel	3-1/2"	5"	5"
Quill Diameter	2-1/2"	3"	3"
Head Swivel	360°	360°	360°
Column Diameter	3-5/8"	4-1/2"	4-1/2"
Number of Power Downfeeds	----	----	3
Range of Power Downfeeds	----	----	0.0047", 0.007", 0.001"
Number of Spindle Speeds	12	12	12
Range of Spindle Speeds	110-2,580 RPM	150-3,000 RPM	150-3,000 RPM
Maximum Table Travel	14"	20-1/2"	20-1/2"
Cross Travel	6"	7"	7"
Working Surface of Table	7-1/2" x 23"	9-1/2" x 31-3/4"	9-1/2" x 31-3/4"
Number of T-Slots	4	4	4
T-Slot Size	9/16"	5/8"	5/8"
T-Slot Centers	1-1/2"	2-1/8"	2-1/8"
Overall Dimensions	36-1/2"L x 37-1/2"W x 35-1/2"H	42-1/2"L x 39-3/4"W x 43-1/2"H	42-1/2"L x 39-3/4"W x 51-1/2"H
Base Dimensions	12-1/2" x 19-3/4"	15-3/4" x 23-3/4"	15-3/4" x 23-3/4"
Motor	1HP, 1PH, 14/7A, 60Hz 115/230V (prewired 115V)	2HP, 1PH, 26/13A, 60Hz 115/230V (prewired 115V)	2HP, 1PH, 26/13A, 60Hz 115/230V (prewired 115V)
Net Weight (approx.)	440 lbs.	660 lbs.	700 lbs.
Shipping Weight (approx.)	540 lbs.	760 lbs.	800 lbs.

The specifications in this manual are given as general information and are not binding. JET reserves the right to effect, at any time and without prior notice, changes or alterations to parts, fittings, and accessory equipment deemed necessary for any reason whatsoever.

5.0 Contents of Shipping Container

1 Mill/Drill Machine

Accessory Package:

- 1 1/2" Drill Chuck w/ Chuck Key
- 1 Adjustable Carbide Facemill
- 1 Facemill Arbor
- 1 Bolts, Nuts, and Washers to Attach Vise to Table
- 1 2-1/2" Angle Vise (JMD-15)
- 1 3" Angle Vise (JMD-18/18PFN)
- 3 Handle Rods (JMD-15/18)
- 3 Rubber Knobs (JMD-15/18)
- 2 Rubber Knobs (JMD-18PFN)
- 1 3/8"x1" Hex Socket Cap Screw
- 1 3/8" Washer
- 1 Crank Body (Installed)
- 1 Crank Handle
- 1 Spindle Guard Assembly
- 1 3mm Hex Wrench
- 1 4mm Hex Wrench
- 1 5mm Hex Wrench
- 1 23mm Wrench (JMD-18/18PFN)
- 3 Hand Wheels w/ Handles
- 1 Can Touch-Up Paint
- 1 Owner's Manual
- 1 Warranty Card
- 1 Lifting Hook (installed 18in. model only)

6.0 Unpacking and Clean-up

1. Finish removing the crate from the mill/drill. Unbolt the machine from the crate bottom. Report shipping damage, if any, to your distributor.
2. Clean all rust protected surfaces using a mild commercial solvent, kerosene or diesel fuel. Do not use paint thinner, gasoline, or lacquer thinner. These will damage painted surfaces. Cover all cleaned surfaces with a light film of Mobil DTE® Oil Heavy Medium.
3. JMD-18/18PFN only: Open the belt cover and thread the lifting hook into the head.
4. Carefully lift the mill/drill with properly rated equipment to a sturdy stand or work bench. (Use the lifting hook on the JMD-18/18PFN. On the JMD-15, place straps beneath the head, next to the column.)
5. Remove the lifting hook (JMD-18/18PFN).

Tools Needed for Assembly

8" Adjustable Wrench or 1/4" to 1-1/4" Combination Wrench Set



(JMD-18 shown with optional CS-18 stand)



(JMD-18/18PFN only)

7.0 Assembly

1. Screw rubber handles (A, Fig. 1) onto handle rod (B, Fig. 1). Screw handle rod into downfeed hub (C, Fig. 1) and tighten. Flat spot on rod accommodates a combination or adjustable wrench. **Note:** Handle shafts are already installed into hub on JMD-18PFN.
2. Repeat for other two rod assemblies.
3. Slide crank (D, Fig. 2) onto shaft and tighten set screw (E, Fig. 2). Be sure set screw seats on flat part of shaft.
4. Thread handle (F, Fig. 2) into crank and tighten.
5. Slide handwheel (G, Fig. 3) onto table handwheel shaft and tighten set screw. Insert handle (H, Fig. 3) into handwheel and tighten.
6. Repeat for two remaining table hand wheels.
7. Install spindle guard assembly (Figure 3a).



Fig. 1

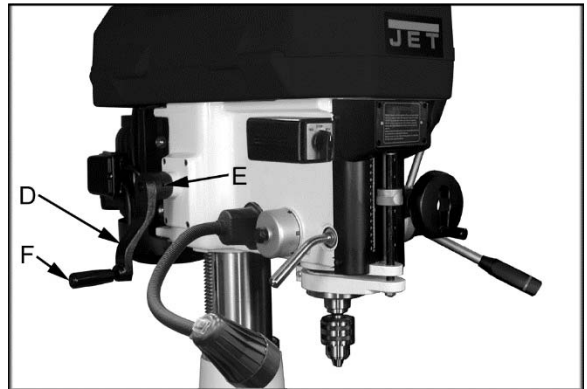

Fig. 2



Fig. 3



Fig. 3a

8.0 Installation

⚠WARNING Machine is heavy! Use an appropriate lifting device and use extreme caution when moving the machine to its final location. Failure to comply may cause serious injury.

1. The location for the mill/drill should be well lit, dry, and have room enough to allow the head to rotate 360°.
2. Before bolting the mill/drill to a bench or stand, the unit must be level in both directions. Place a level on the table in both directions.
3. If the table is not level, shim under the low corner(s) until level. Tighten the fastening bolts. Check for level again. Adjust as necessary until the mill/drill is level after the fastening hardware has been tightened.

9.0 Lubrication

Lubricate ball oilers (A, Fig. 4) by the X/Y-axis hand wheels, the oiler at the raising/lowering crank handle, and the oiler on front of the bed once daily with Mobil DTE® Oil Heavy Medium.

Lubricate the ways (B, Fig. 4) once daily with Mobil DTE® Oil Heavy Medium.

If the head does not rise or lower smoothly, apply Mobilith AW2 to the rack, and Mobil DTE® Oil Heavy Medium to the column.

If the feed handles do not turn smoothly, apply Mobilith AW2 to the cross and longitudinal lead screws (C, Fig. 4). Access the cross lead screw by moving the table forward and removing the way cover.

The spindle bearings are permanently sealed and require no lubrication.

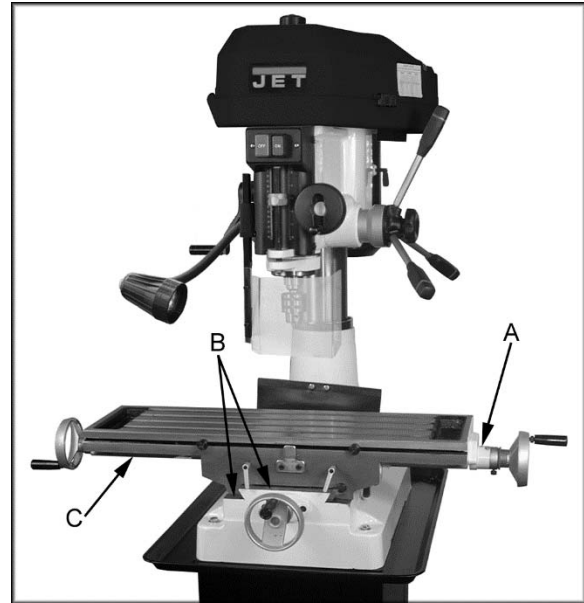

Fig. 4

10.0 Electrical Connections

⚠WARNING A qualified electrician must make all electrical connections. Failure to comply may cause serious injury.

Before making any electrical connections, make sure the power source available is compatible with the machine. Also, turn the machine OFF using the buttons or switch at the front of the machine before connecting to the power source.

The JMD Mill/Drills are rated at 115/230V and come from the factory **prewired at 115V**. The mill/drill comes with a plug designed for use on a circuit with an outlet that looks like the one in Fig. 5, and has a grounding prong as illustrated in Fig. 5.

To switch the Mill/Drill to 230V operation:

1. Disconnect machine from power source.
2. Remove junction box cover on the motor.
3. Change the wires according to the diagram on the inside of the junction box cover, and reinstall junction box cover.
4. Replace thermal relay with one rated for 230V operation (see parts list).
5. Change power plug to one rated 230V, or hard wire the power cord.

Make sure the mill/drill is properly grounded.

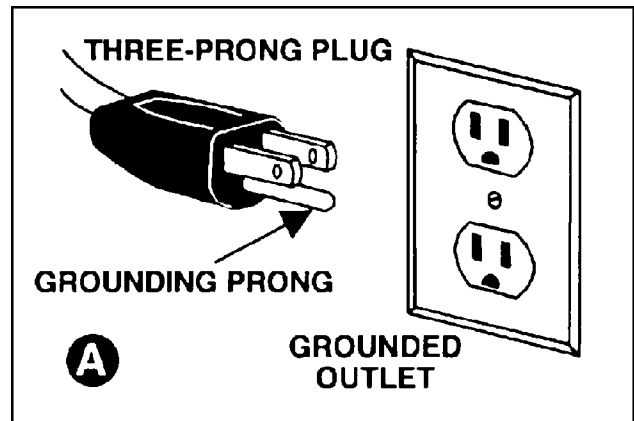

Fig. 5

11.0 Controls

Longitudinal Hand Wheels: (X-axis) (A, Fig. 6)

Located on either side of the table. Moves table side to side.

Cross Feed Hand Wheel: (Y-axis) (B, Fig. 6)

Located on the front of the base. Moves table toward, or away from the column.

Adjustable Table Stops: (C, Fig. 6)

Located on table front. Adjust to stop table at any setting along the longitudinal axis.

Table Locks: (D & E, Fig. 6)

Longitudinal table locks are located on front of the table. Cross-feed table locks are located on the right side under the table. Turn clockwise to lock.

Depth Stop:

JMD-15: (K, Fig. 8) located on the left side. Set nuts for desired depth stop.

JMD-18: (F, Fig. 7) located in the front. Push in the button on the front of the quick adjust stop and move to desired position.

JMD-18PFN: Set the depth stop on the power down feed assembly to desired depth for repetitive drilling to the same depth, see "Power Feed Operation" on page 12.

Downfeed Handles: (G, Fig. 7)

Located on the right side of the head casting. Counter-clockwise movement advances the quill toward the table. Return spring retracts the handles. **Note**: the knob (I, Fig. 7) must be loose for the downfeed handles to work.

Fine Feed Hand Wheel: (H, Fig. 7)

Located on the front of the head casting. To activate, tighten the knob (I Fig. 7) and turn the power feed speed range dial (J, Fig. 7) to zero.

Fig. 6

Fig. 7

Fig. 8

9

Motor Mount Lock Lever: (A, Fig. 9)

Located on the right side of the head casting. Locks and unlocks the motor mounting plate enabling the user to tension v-belts.

Head Pivot Lock: (B, Fig. 9)

Located on the right rear of the head casting. Loosen two hex nuts to rotate the head 360°. Tighten two hex nuts to lock the head in position.

On-Off Switch: (C, Fig. 10)

Turns spindle on and off, and changes spindle direction. Allow the spindle to come to a stop before reversing rotation.

Quill Lock Handle: (D, Fig. 10)

Located on the front left of the head casting. Turn clockwise to lock the quill in the desired position. Turn counter-clockwise to release.

Head Elevating Crank Handle: (E, Fig. 10)

Located at left rear of head casting. Loosen head pivot lock nuts (B, Fig. 9) and turn handle clockwise to raise head on the column and counter-clockwise to lower head.

⚠WARNING This machine is designed and intended for use by properly trained and experienced personnel only. If you are not familiar with the proper and safe use of mill/drills, do not use this machine until proper training and knowledge have been obtained. Failure to comply may cause serious injury.

12.0 Adjustments

12.1 Changing Spindle Speeds

1. Disconnect the machine from the power source, unplug.
2. Loosen the motor mount lock lever (F, Fig. 11) and pull the motor toward the head casting to release tension on the v-belts.

3. Release two latches (G, Fig. 11) on belt cover and slide pulley guard open (I, Fig. 11).



Fig. 9

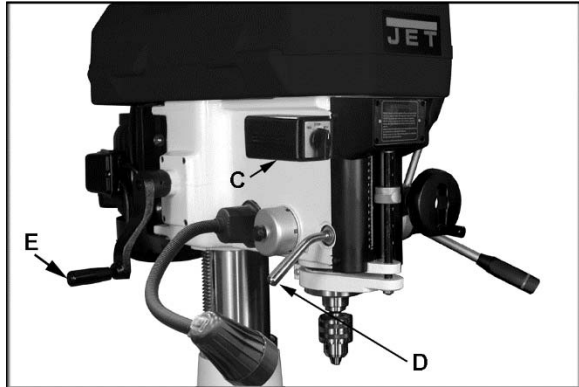

Fig. 10



Fig. 11

4. Arrange the v-belts (A, Fig. 12) on the pulleys (B, Fig. 12) for the desired speed according to the speed chart (H, Fig. 11) on the belt cover.
5. Tension the v-belts by pushing the motor away from the head casting and locking the motor mount lock lever (F, Fig. 11). **Note:** Proper tension is achieved when the slack in the belt is taken up and the belt does not slip during operation of the mill/drill.

12.2 Arbor Replacement

1. **Disconnect machine from the power source, unplug.**
2. Release two latches (G, Fig. 11) on the belt cover and slide the pulley guard open (I, Fig. 11).
3. Hold the spindle pulley (B, Fig. 12) to keep the pulley from moving while loosening the drawbar (C, Fig. 12) with a wrench.
4. Loosen the drawbar approximately three to four full turns.
5. Tap the drawbar head with a rubber mallet to dislodge the arbor.

CAUTION Do not loosen the drawbar more than three or four turns before hitting with a rubber mallet. Damage to the drawbar threads may occur.

6. Grasp the arbor with one hand while loosening the drawbar with the other. Continue to loosen the drawbar until the arbor can be withdrawn from the spindle. Wipe out the spindle with a clean dry rag.
7. Wipe down the new arbor with a clean dry rag and place the arbor into the spindle. Thread the drawbar into the arbor. Tighten the drawbar with a wrench while holding on to the spindle pulley.

WARNING Use caution when tightening drawbar. Do not allow hand to get pinched between pulley and belt. Failure to comply may cause serious injury.

Note: For best results, all milling operations should be done with the quill/spindle as close to the head assembly as possible. Lock spindle and table in place before starting milling operations.



Fig. 12

12.3 Gib Adjustment

After a period of time, movement of the table over the ways will cause normal wear. To adjust the gibs for this wear:

1. The horizontal gib adjustment screw (A, Fig. 13) is found to the right on the table face. The traverse gib adjustment screw (B, Fig. 13) is found on the right side of the saddle under the table.
2. Turn each screw slightly clockwise to tighten. Turn the table hand wheels and check the tension.
3. Re-adjust as required.

12.4 Power Feed Operation (JMD-18PFN only)

CAUTION Make all power feed settings with power to the machine turned off. Failure to comply may cause damage to the machine.

1. Set the power feed speed range dial (C, Fig. 14) to the desired rate.
2. Set the depth stop to the desired setting by lowering the quill to the desired depth and holding in place. Turn the collar (D, Fig. 14) counter-clockwise until zero is indicated and then tighten the lock handle (E, Fig. 14)
3. Start the mill/drill and pull one of two handles (F, Fig. 14) away from the column to start the power downfeed.
4. Once the downfeed has reached the depth stop, the trip will release and the spindle will retract.
5. To stop the feed before the cycle has ended or to disengage the fine feed (G, Fig. 14), press one of two handles toward the column.

12.5 Adjusting Spindle Return Spring

The spindle return comes pre-set from the factory and should not need any adjustment.

1. You do **not** want to remove the spring cap (H, Fig. 15).
2. Loosen knob (I, Fig. 15) just enough to rotate spring cap past the notch (J, Fig. 15).

3. Rotate the spring cap clockwise to decrease spring tension. Rotate the spring cap counter-clockwise to increase spring tension.

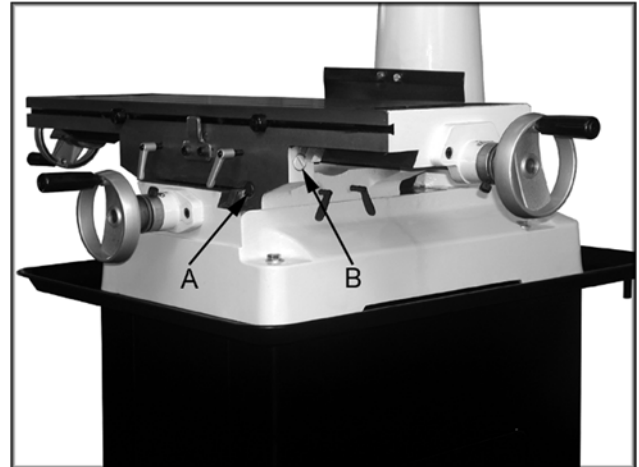

Fig. 13

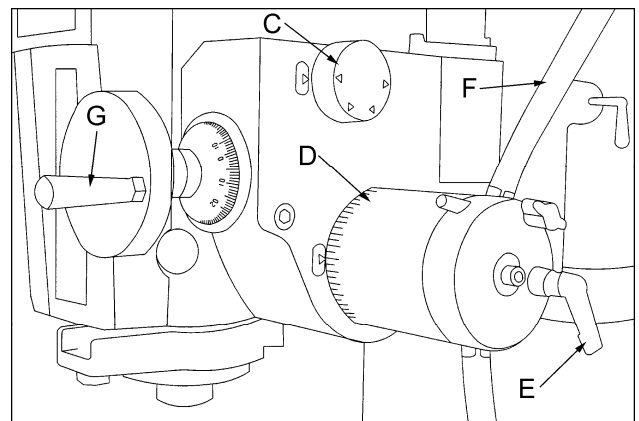

Fig. 14

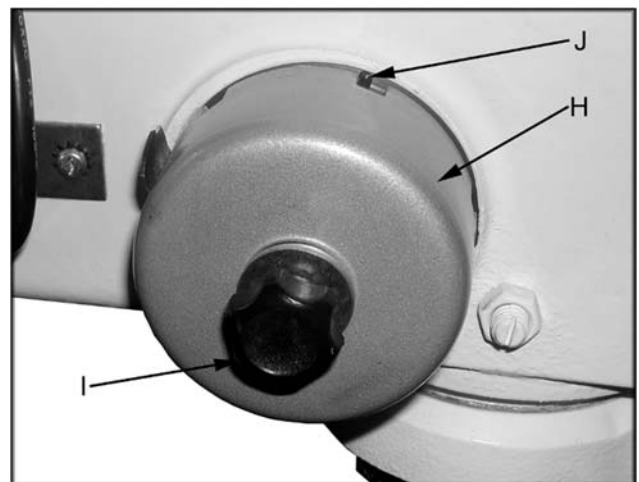
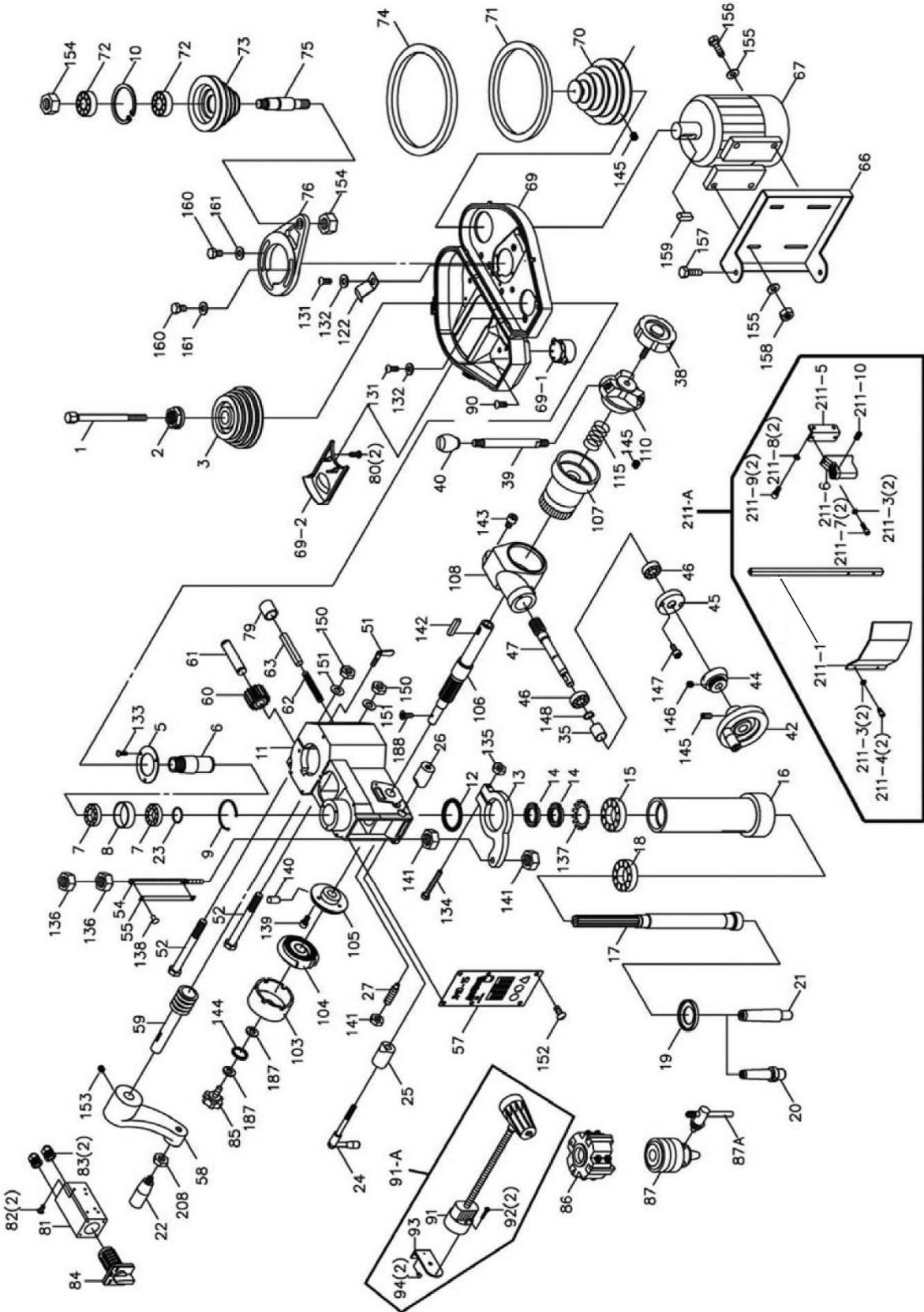

Fig. 15

13.0 Replacement Parts

13.1.1 JMD-15 Head Assembly – Exploded View



13.1.2 JMD-15 Head Assembly – Parts List

Index No.	Part No.	Description	Size	Qty
1	JMD15-001	Drawbar		1
2	JMD15-002A	Spindle Lock Nut		1
3	JMD15-003	Spindle Pulley		1
5	JMD15-005	Outer Bearing Plate		1
6	JMD15-006A	Spindle Taper Sleeve		1
7	BB-600ZZ	Ball Bearing	600ZZ	2
8	JMD15-008	Bearing Spacer		1
9	JMD15-009	C-Ring		1
10	JMD18-010	C-Ring		1
11	JMD15-011	Head		1
12	JMD15-012	Rubber Flange		1
13	JMD15-013	Feed Base		1
14	JMD15-014	Lock Nut		2
15	BB-30205	Taper Roller Bearing	30205	1
16	JMD15-016	Rack Sleeve		1
17	JMD15-017	Spindle Shaft		1
18	BB-30206	Taper Roller Bearing	30206	1
19	JMD15-019	Bearing Cap		1
20	JMD15-020	Cutting Arbor		1
21	JMD15-021	Chuck Arbor	R8 x JT6	1
22	JMD18-022	Handle		1
23	JMD15-023	Retainer Ring		1
24	JMD15-024	Lock Handle (Serial #14022982 and lower)		1
	JMD15-024N	Lock Handle (Serial #14022983 and higher)		1
25	JMD15-025	Fixed Collar		1
26	JMD15-026	Fixed Collar Thread		1
27	JMD15-027	Screw Key	3/8	1
35	JMD18-035	Bearing Spacer		1
38	JMD18-038	Lock Bolt w/ Knob		1
39	JMD18-039	Handle Rod		3
40	JMD18-040	Knob		3
42	JMD18-042	Feed Handle Wheel		1
44	JMD18-044	Micro Adjusting Indicator		1
45	JMD18-045	Worm Cover		1
46	BB-620ZZ	Ball Bearing	620ZZ	2
47	JMD18-047	Worm Shaft		1
51	JMD18-051	Leaf Screw		1
52	JMD15-052	Head Lock Bolt	1/2"x7"	2
54	JMD15-054	Graduated Rod and Dial Assembly		1
55	JMD15-054	Depth Scale		1
57	JMD15-057	Name Plate (Serial #14022982 and lower)		1
	JMD15-057A	Name Plate (Serial #14022983 and higher)		1
58	JMD15-058	Head Handle		1
59	JMD15-059	Worm Shaft		1
60	JMD15-060	Worm Gear		1
61	JMD15-061	Shaft		1
62	JMD18-062	Compression Spring		1
63	JMD15-063	Pin		1
66	JMD15-066	Motor Mount		1
67	JMD15-067	Motor (Serial #06041349 and lower)	1HP, 1Ph	1
	JMD15-067N	Motor (Serial #06041350 and higher)	1HP, 1Ph	1
68	JMD15-067A	Capacitor (not shown)	150MF, 250VAC	1
69	JMD15-069P	Belt Cover		1
69-1	JMD15-069P1	Upper Belt Cover Cap		1
69-2	JMD15-069P2	Upper Belt Cover Plate		1
70	JMD15-070	Motor Pulley (Serial #06041349 and lower)		1
	JMD15-070N	Motor Pulley (Serial #06041350 and higher)		1

Index No.	Part No.	Description	Size	Qty
71	VB-A30	V-Belt	A30	1
72	BB-6204Z	Ball Bearing	6204Z	2
73	JMD15-073	Inter Pulley		1
74	VB-A38	V-Belt	A38	1
75	JMD15-075P	Inter Pulley Shaft		1
76	JMD15-076P	Speed Change Inter Pulley Base		1
79	JMD18-079	Rubber Collar		1
81	JMD18-122	Switch Box		1
82	JMD18-123	Cross Round Head Screw	3/16"x3/8"	2
83	JMD18-124	Cable setting nut	PG13.5	2
84	JMD18-121-1	F/R Switch		1
85	JMD18-085	Screw w/ Plumb Knob		1
86	JMD15-086	Cutter		1
	JMD15-086A	Cutter Insert (not shown)		4
87	JMD15-087	Drill Chuck		1
87A	JMD15-087A	Chuck Key		1
90	JMD15-090	Self Tapping Screw		2
91-A	JMD18-116	Lamp Assembly (includes 91~94)(Serial #14022983 and higher)		1
91	JMD18-116-1	Lamp		1
92	JMD15-092	Cross Round Head Screw	M4x35L	2
93	JMD15-093	Working Lamp Base		1
94	JMD15-094	Hex. Socket Head Screw	M6x12L	2
103	JMD18-103	Spring Cover		1
104	JMD18-104	Spring		1
105	JMD18-105	Spring Base		1
106	JMD15-106	Pinion Shaft		1
107	JMD18-107	Worm Gear		1
108	JMD18-108	Gear Housing		1
110	JMD18-110	Hub		1
115	JMD18-115	Spring		1
122	JMD18-077	Clip Plate		1
131	TS-0813032	Pan Head Screw	1/4"x1/2"	4
132	TS-0680021	Washer	1/4"	4
133	JMD18-133	Round Head Screw	1/4"x3/8"	3
134	TS-0050091	Hex Head Bolt	1/4"x2"	1
135	TS-0561011	Hex Nut	1/4"	1
136	TS-0561051	Hex Nut	1/2"	2
137	JMD15-137	Lock Washer		1
138	JMD15-138	Rivet		2
139	JMD18-139	Round Head Screw	3/16"x3/4"	3
140	JMD18-140	Spring Pin	3x12"	2
141	TS-0561031	Hex Nut	3/8"	3
142	JMD18-142	Key	7x7x20	1
143	TS-0208041	Hex Socket Cap Screw	5/16"x3/4"	2
144	TS-0680021	Washer	1/4"	1
145	TS-0270021	Set Screw	5/16"x5/16"	3
146	TS-0267031	Set Screw	1/4"x5/16"	1
147	JMD18-147	Round Head Screw	3/16"x1/2"	2
148	JMD18-148	C-Retainer Ring		1
150	TS-0561051	Hex Nut	1/2"	2
151	TS-0680061	Washer	1/2"	2
152	JMD15-152	Round Head Screw	M6x1.25	6
153	TS-0271061	Set Screw	3/8"x5/8"	1
154	TS-0561071	Hex Nut	5/8"	2
155	TS-0680031	Washer	5/16"	8
156	TS-0051051	Hex Head Bolt	5/16"x1"	4
157	TS-0060051	Hex Head Bolt	3/8"x1/2"	2
158	TS-0561021	Hex Nut	5/16"	4

Index No.	Part No.	Description	Size	Qty
159	JMD18-159	Key (Serial #06041349 and lower)	7x7x40	1
	JMD18-159N	Key (Serial #06041350 and higher)	6x6x45	1
160	TS-0051071	Hex Head Bolt	5/16"x1-1/2"	1
161	TS-0680031	Washer	5/16"	2
187	TS-0680021	Washer	1/4"	2
188	JMD18-188	Pan Head Screw	3/16"x3/8"	1
208	TS-0561031	Hex Nut	3/8"	1
209	JMD18-119	Lifting Hook	5/16"x50mm	1
210	TS-0570021	Hex Nut	5/16"-18	1
211-A	JMD15-211A	Chuck Guard Assembly		1
211-1	JMD15-211-1	Chuck Guard & Support Rod		1
211-3	TS-2361051	Spring Washer	M5	4
211-4	TS-1502021	Socket Head Cap Screw	M5x10	2
211-5	JMD15-211-5	Chuck Guard Bracket		1
211-6	JMD18-125-5	Rotary Supporting Base		1
211-7	JMD18-125-6	Hex. Socket Head Screw	M5x15L	2
211-8	JMD15-211-8	Spring Washer	M6	2
211-9	JMD15-211-9	Hex. Socket Head Screw	M6x15L	2
211-10	JMD18-125-7	Hex. Socket Headless Screw	M5x10L	1
	JMD15-SC	Speed Chart Label (not shown)		1
	JMD15-JL	Jet Label (not shown)		1
	JMD15-ID	I.D. Label (not shown)		1
	JMD15-AP	Accessory Package (not shown) *		1
	JMD15-303	Thermal Relay (not shown)	18A, 115V	1

*** Contents of the Accessory Package (JMD15-AP):**

	JMD15-020	Cutter Arbor		1
	JMD15-039	Handle Rod		3
	JMD15-040	Knob		3
	JMD15-087	Drill Chuck		1
	JMD15-087A	Chuck Key		1
	JMD15-086	Cutter		1
	365534	Angle Vise		1
	JMD15-022	Handle		4
	JMD15-201	Wheel		3
	JMD15-058	Handle Crank		1
	TS-152704	Hex Wrench	3mm	1
	TS-152705	Hex Wrench	4mm	1
	TS-152706	Hex Wrench	5mm	1
	JMD15-381	Washer		1
	JMD15-380	Hex Bolt		1
	JMD15-377	Hex Bolt		2
	JMD15-378	Hex Nut		2
	JMD15-379	Washer		2
	MP-007	Touch Up Paint		1

13.2.1 JMD-15 Table, Base, and Column Assembly – Exploded View

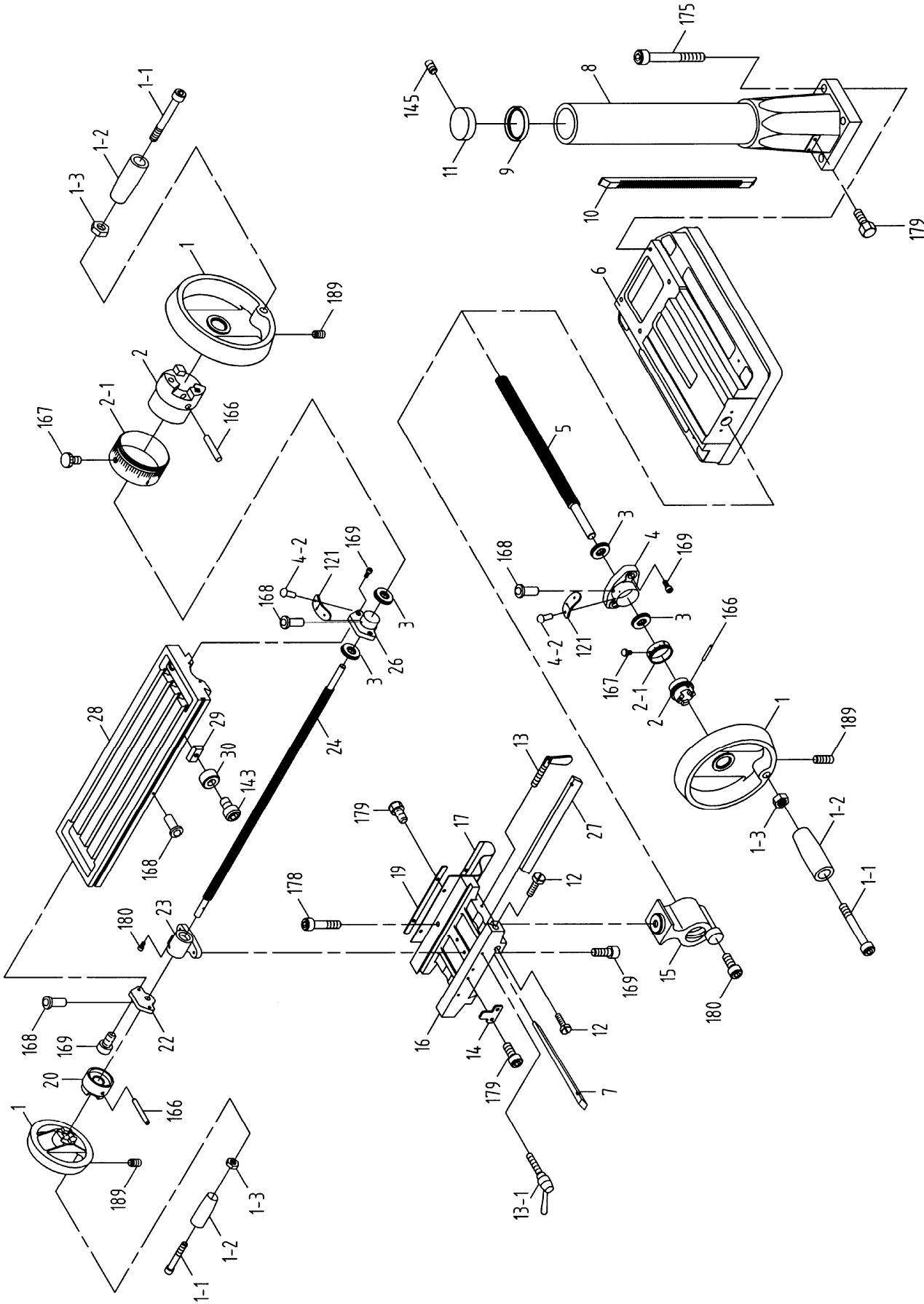

13.2.2 JMD-15 Table, Base, and Column Assembly – Parts List

Index No.	Part No.	Description	Size	Qty
1	JMD18-201	Table Hand Wheel		3
1-1	JMD18-201-1	Bolt		3
1-2	JMD18-201-2	Handle		3
1-3	JMD18-201-3	Nut		3
2	JMD18-202	Dial Clutch		2
2-1	JMD18-202-1	Graduated Dial		2
3	BB-51103	Thrust Bearing	51103	4
4	JMD15-204	Square Flange		1
4-2	JMD18-204-2	Rivet		4
5	JMD15-205	Table Screw		1
6	JMD15-206	Base		1
7	JMD15-207	Gib Strip		1
8	JMD15-208	Column Base		1
9	JMD15-209	Column Flange Ring		1
10	JMD15-210	Rack		1
11	JMD15-211	Column Cap		1
12	JMD15-212	Adjustment Screw		2
13	JMD18-213	Leaf Screw		2
13-1	JMD18-213	Locking Handle		2
14	JMD18-214	Block		1
15	JMD18-215	Table Base Nut		1
16	JMD15-216	Center Base		1
17	JMD15-217	Way Cover		1
19	JMD18-219	Bracket Plate		1
20	JMD18-220	Table Clutch		1
22	JMD15-222	Left Flange		1
23	JMD18-223	Table Nut		1
24	JMD15-224	Table Screw		1
26	JMD15-226	Right Flange		1
27	JMD15-227	Gib Strip		1
28	JMD15-228	Table		1
29	JMD18-229	Block		2
30	JMD18-230	Ring		2
121	JMD15-121	Indicator Plate		2
143	TS-0207021	Hex Socket Cap Screw	1/4"x1/2"	2
145	TS-0270021	Set Screw	5/16"x5/16"	1
166	JMD18-366	Spring Pin		3
167	JMD18-367	Zero Indicator w/ Screw	1/4"x3/8"	2
168	JMD18-368	Oil Ball		5
169	TS-0209031	Hex Socket Cap Screw	3/8"x3/4"	8
175	TS-0061071	Hex Head Bolt	7/16"x2"	4
178	TS-0208111	Hex Cap Bolt	5/16"x2-1/4"	1
179	TS-0051011	Hex Cap Bolt	5/16"x1/2"	6
180	TS-1502041	Hex Socket Cap Screw	M5x16	2
189	TS-0267041	Set Screw	1/4"x3/8"	3

13.3.1 JMD-18/18PFN Head Assembly – Exploded View

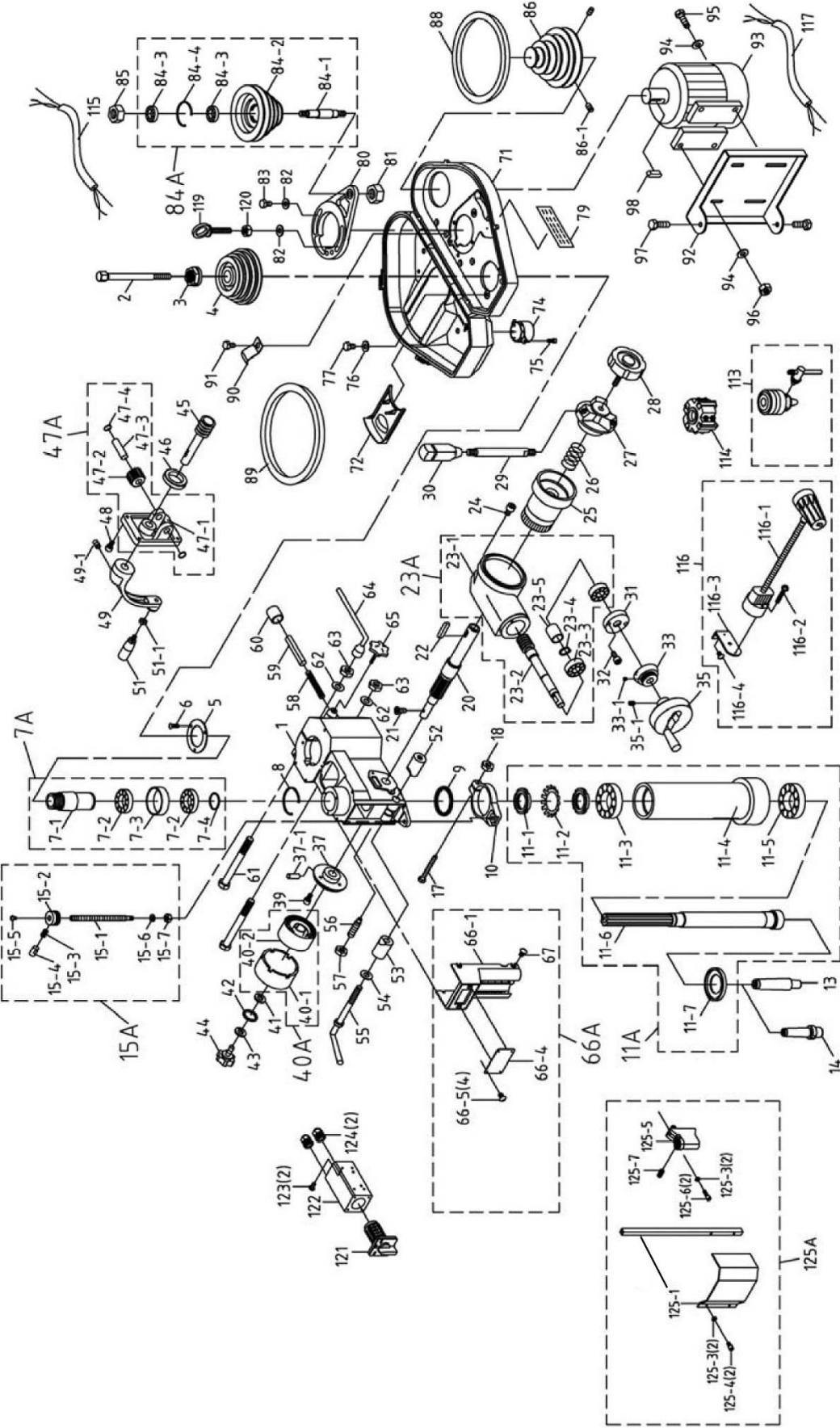

13.3.2 JMD-18/18PFN Head Assembly – Parts List

Index No.	Part No.	Description	Size	Qty
1	JMD18N-001	Head Body		1
2	JMD18-001	Drawbar	R8	1
3	JMD18-002A	Spindle Lock Nut		1
4	JMD18-003A	Spindle Pulley		1
5	JMD18-005	Outer Bearing Plate	105x66	1
6	JMD18-133	Round Head Screw	1/4"x3/8"	3
7A	JMD18-006A	Spindle Taper Sleeve Assembly		1
7-1	JMD18-006	Spindle Taper Sleeve		1
7-2	BB-6009ZZ	Ball Bearing	6009ZZ	2
7-3	JMD18-008	Spacer	74x68	1
7-4	JMD18-023	Fixed Ring	2x4	1
8	JMD18-009	C-Retaining Ring	3x80	1
9	JMD18-012	Rubber Flange		1
10	JMD18N-010	Feed Base		1
11A	JMD18-014A	Rack Sleeve Set		1
11-1	JMD18-014	Lock Nut		2
11-2	JMD18-137	Lock Washer	30206	1
11-3	BB-30206	Taper Roller Bearing		1
11-4	JMD18-016	Rack Sleeve	R8	1
11-5	BB-30207	Taper Roller Bearing	30207	1
11-6	JMD18-017	Spindle Shaft	R8	1
11-7	JMD18-019	Bearing Cap	R8	1
13	JMD18-021	Chuck Arbor	R8 7/16"	1
14	JMD18-020	Cutter Arbor	25.4 7/16"	1
15A	JMD18N-015A	Graduated Rod Assembly		1
15-1	JMD18N-15-1	Depth Scale Stud		1
15-2	JMD18N-15-2	Adjustable Stop		1
15-3	JMD18N-15-3	Spring		1
15-4	JMD18N-15-4	Push Button		1
15-5	JMD18N-15-5	Hex Socket Cap Screw	M5x10	1
15-6	JMD18N-15-6	Washer	3/8"	1
15-7	JMD18N-15-7	Hex Nut	3/8"	1
17	TS-0050091	Hex Head Screw	1/4"x2"	1
18	TS-0561011	Hex Nut	1/4"	1
20	JMD18-106	Pinion Shaft		1
21	JMD18-188	Flat Cross Head Screw	3/16"x3/8"	1
22	JMD18-142	Key	7x7x20mm	1
23A	JMD18N-023A	Gear Housing Assembly		1
23-1	JMD18N-023	Gear Housing		1
23-2	JMD18-047	Worm Shaft		1
23-3	BB-6202Z	Ball Bearing	6202ZZ	2
23-4	JMD18-148	C-ring	15	1
23-5	JMD18-035	Bearing Spacer	34x27.5	1
24	TS-0208021	Hex Socket Cap Screw	5/16"x1/2"	2
25	JMD18-107	Worm Gear		1
26	JMD18-115	Spring		1
27	JMD18-110	Hub		1
28	JMD18-038	Knob		1
29	JMD18-039	Handle Rod		3
30	JMD18N-030	Knob		3
31	JMD18-045	Flange		1
32	JMD18-047	Round Head Screw	3/16"x3/8"	2
33	JMD18N-033	Micro Adjusting Indicator		1
33-1	TS-0267021	Set Screw	1/4"x1/4"	1
35	JMD18N-035A	Feed Handle Wheel Assembly		1
35-1	JMD18N-035-1	Set Screw	M8x10	1

Index No.	Part No.	Description	Size	Qty
37	JMD18-105	Spring Base		1
37-1	JMD18-140	Spring Pin		2
39	JMD18-139	Round Head Screw	3/16"x3/4"	3
40A	JMD18-103A	Spring Cover Assembly		1
40-1	JMD18-103	Spring Cover		1
40-2	JMD18-104	Spring		1
41	JMD18-187	Washer	1/4"x1"	1
42	TS-0680021	Washer	1/4"	1
43	JMD18-187	Lock Washer	1/4"x1"	1
44	JMD18-085	Knob		1
45	JMD18-059	Worm Shaft		1
46	JMD18-114	Bushing		1
47A	JMD18-101A	Head Raise Bracket Assembly		1
47-1	JMD18-101	Head Raise Bracket		1
47-2	JMD18-060	Worm Gear		1
47-3	JMD18-061	Shaft	9/16"	1
47-4	JMD18-154	C-ring	S14	2
48	TS-0207061	Hex Socket Cap Screw	1/4"x1"	4
49	JMD18-058	Head Handle		1
49-1	TS-0271061	Set Screw	3/8"x5/8"	1
51	JMD18-022	Handle		1
51-1	TS-0561031	Hex Nut	3/8"	1
52	JMD18-026	Fixed Collar (Thread)		1
53	JMD18-025	Fixed Collar		1
54	JMD18N-054	Washer	1/2"x7/8"	1
55	JMD18-024	Handle Rod		1
56	JMD18-027	Screw Key	3/8"	1
57	TS-0561031	Hex Nut	3/8"	1
58	JMD18-062	Spring		1
59	JMD18-063	Pin		1
60	JMD18-079	Rubber Collar		1
61	JMD18-052	Bolt	5/8"x6"	2
62	TS-0680081	Washer	5/8"	2
63	TS-0561071	Hex Nut	5/8"	2
64	JMD18-050	Lock Handle		1
65	JMD18N-065	Knob		1
66A	JMD18N-066A	Front Cover Plate Assembly (serial no: previous to 11043083)		1
66A	JMD18N-066B	Front Cover Plate Assembly (includes 66-1,66-4,66-5) serial no: 11043083 and higher		1
66-1	JMD18N-066-1	Front Cover Plate		1
66-4	JMD18N-066-4	Front Cover Plate		1
66-5	TS-1533032	Phillips Pan Head Machine Screw	M5x10	4
67	JMD18N-067	Round Head Screw	M6x12	4
71	JMD18-069	Poly Belt Cover		1
72	JMD18-069A	Pulley Cover		1
74	JMD18-069-1	Spindle Cover		1
75	JMD18-069-3	Screw	3mm	2
76	TS-0680032	Flat Washer	5/16"	4
77	TS-0051011	Hex Head Bolt	5/16"x1/2"	4
79	JMD18-SC	Spindle Speed Chart		1
80	JMD18N-080	Pulley Base		1
81	TS-0561071	Hex Nut	5/8"	1
82	TS-0680031	Washer	5/16"	2
83	TS-0051071	Hex Head Bolt	5/16"x1-1/2"	1
84A	JMD18-075A	Inter Pulley Assembly		1
84-1	JMD18-075	Inter Pulley Shaft		1
84-2	JMD18-073	Inter Pulley		1
84-3	BB-6204Z	Ball Bearing	6204ZZ	2

Index No.	Part No.	Description	Size	Qty
84-4	JMD18-010	C-ring	2x52	1
85	TS-0561071	Hex Nut	5/8"	1
86	JMD18-070	Motor Pulley (Serial #06013377 and lower)		1
	JMD18-070N	Motor Pulley (Serial #06013378 and higher)		1
86-1	TS-0270021	Set Screw	5/16"x5/16"	2
88	VB-B33	V-Belt	B33	1
89	VB-B42	V-Belt	B42	1
90	JMD18-077	Wire Relief Retainer		1
91	TS-0051011	Hex Head Screw	5/16"x1/2"	1
92	JMD18-066	Motor Mount Plate		1
93	JMD18-067	Motor (Serial #06013377 and lower)	2HP, 1Ph, 230V Only	1
	JMD18-067N	Motor (Serial #06013378 and higher)	2HP, 1Ph, 230V Only	1
	JMD18-067AN	Motor (Serial #11053083 and higher)	2HP, 1PH, 115/230V	1
94	TS-0680031	Flat Washer	5/16"	8
95	TS-0051051	Hex Head Bolt	5/16"x1"	4
96	TS-0561021	Hex Nut	5/16"	4
97	TS-0061011	Hex Head Bolt	7/16"x3/4"	2
98	JMD18-159	Key (Serial #06013377 and lower)	7x7x37mm	1
	JMD18-159N	Key (Serial #06013378 and higher)	8x7x45mm	1
113	561704	Drill Chuck w/ Chuck Key	1/2" JT6	1
114	JMD18-086	Milling Cutter Assembly	25.4mm (3")	1
	JMD18-086A	Cutter Insert	12x12mm	4
115	JMD18N-115	Power Cable	230V	1
116	JMD18-116	Lamp Assembly (incl. 116-1~116-4)(Serial #13114003 and higher)		1
116-1	JMD18-116-1	Lamp		1
116-2	JMD15-092	Cross Round Head Screw	M4x35L	2
116-3	JMD15-093	Working Lamp Base		1
116-4	JMD15-094	Hex. Socket Head Screw	M6x12L	2
117	JMD18N-117	Motor Cable		1
119	JMD18-119	Lifting Hook	5/16"x50mm	1
120	TS-0570021	Hex Nut	5/16"-18	1
121	JMD18-121-1	F/R Switch		1
122	JMD18-122	Switch Box		1
123	JMD18-123	Cross Round Head Screw	3/16"-24UNCx3/8"L	2
124	JMD18-124	Cable Setting Nut (Serial #13053752 and lower)	PG13.5	2
	JMD18-124N	Cable Setting Nut (Serial #13053753 and higher)	PG16	2
125A	JMD18-125A	Spindle Guard Assembly		1
125-1	JMD18-125-1	Chuck Guard & Support Rod		1
125-3	TS-2361051	Spring Washer	M5	4
125-4	TS-1502021	Socket Head Cap Screw	M5x10L	2
125-5	JMD18-125-5	Rotary Supporting Base		1
125-6	JMD18-125-6	Hex Socket Head Screw	M5x15L	2
125-7	JMD18-125-7	Hex. Socket Headless Screw	M5x10L	1
	JMD15-JL	Jet Label (not shown)		1
	JMD18-ID	I.D. Label (not shown)		1
	JMD18-303	Thermal Relay (not shown)	15A, 220V	1
	JMD18-303-1	Thermal Relay (not shown)	30A 115V	1
	JMD18-320-01	Special Arbor Washer (not shown)		1
	JMD18-320-02	Special Arbor Bolt (not shown)		1
	JMD18-36701	Capacitor (not shown)	300MF, 250VAC	1
	BD1325R-X02	Centrifugal Switch (not shown)		1
	JMD18-AP	Accessory Package (not shown) *		1

*** Contents of the Accessory Package:**

..... JMD18-020	Cutter Arbor.....	1
..... JMD18-022	Handle.....	4
..... JMD18-039	Handle Rod	3
..... JMD18-040	Knob	3
..... JMD18-050	Lock Handle	1
..... 561704	Drill Chuck w/Chuck Key.....	1
..... JMD18-086	Cutter.....	1
..... JMD18-021	Chuck Arbor (Installed).....	1
..... 365534	Angle Vise	1
..... JMD18-058	Handle Crank	1
..... JMD18-201	Wheel.....	3
..... TS-152704	Hex Wrench	3mm..... 1
..... TS-152705	Hex Wrench	4mm..... 1
..... TS-152706	Hex Wrench	5mm..... 1
..... TS-0209051	Hex Socket Cap Screw.....	3/8x1..... 1
..... TS-0680041	Flat Washer.....	3/8..... 1
..... 365534-01	Hardware Package(Hex Cap Screw,Nut,and Washer).....	2

13.4.1 JMD-18 Table, Base, and Column Assembly – Exploded View

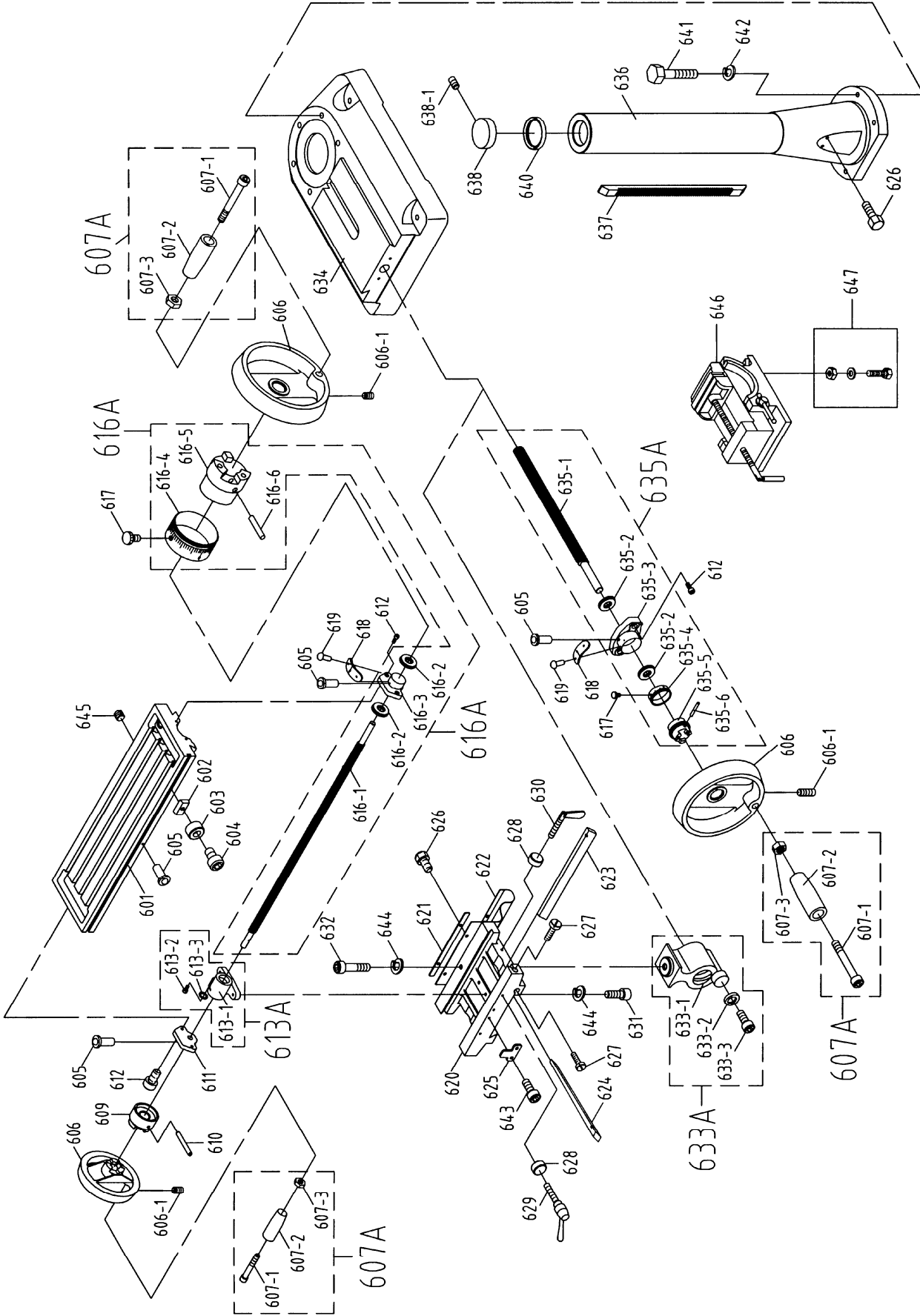

13.4.2 JMD-18 Table, Base, and Column Assembly – Parts List

Index No.	Part No.	Description	Size	Qty
601	JMD18-228	Table	31L	1
602	JMD18-229	Fixed Block		2
603	JMD18-230	Movable Ring		2
604	TS-0207021	Hex Socket Head Screw	1/4"x1/2"	2
605	JMD18-368	Oil Ball	1/4"	5
606	JMD18-201	Table Handle Wheel		3
606-1	TS-0267041	Set Screw	1/4"x3/8"	3
607A	JMD18-201A	Handle Assembly		3
607-1	JMD18-201-1	Hex Socket Head Screw	3/8"x16UNC	3
607-2	JMD18-201-2	Knob		3
607-3	JMD18-201-3	Hex Nut	3/8"	3
609	JMD18-220	Table Clutch		1
610	JMD18-366	Pin	5x38	1
611	JMD18-222	Left Flange		1
612	TS-0208062	Hex Socket Head Screw	5/16"x1"	6
613A	JMD18-223A	Table Nut Set		1
613-1	JMD18-223	Table Nut	TM23.7-10	1
613-2	TS-1502041	Cheese Head Mach Screw	M5x16	1
613-3	TS-1550031	Flat Washer	M5	1
616A	JMD18-224A	Table Screw Assembly		1
616-1	JMD18-224	Table Lead Screw		1
616-2	BB-51103	Thrust Bearing	51103	2
616-3	JMD18-226	Right Flange		1
616-4	JMD18-202-1	Graduated Dial		1
616-5	JMD18-202	Dial Clutch		1
616-6	JMD18-366	Pin	5x38L	1
617	JMD18N-617	Link Screw		2
618	JMD18-121	Link Plate		2
619	JMD18-204-2	Rivet	2mm	4
620	JMD18-216	Center Base	31L	1
621	JMD18-219	Antidust Plate		1
622	JMD18-217	Antidust Plate Assembly		1
623	JMD18-227	Gib Strip	31L	1
624	JMD18-207	Gib Strip	31L	1
625	JMD18-214	Fixed Block		1
626	TS-0051011	Hex Head Screw	5/16"x1/2"	4
627	JMD18-212	Gib Strip Bolt		2
628	JMD18N-628	Bushing		4
629	JMD18-213-1	Locking Handle		2
630	JMD18-213	Leaf Screw		2
631	TS-0208061	Hex Socket Head Screw	5/16"x1"	2
632	TS-0051101	Hex Socket Head Screw	5/16"x2-1/4"	1
633A	JMD18-215A	ACME Nut Assembly		1
633-1	JMD18-215	ACME Nut	TM23	1
633-2	TS-1550031	Flat Washer	M5	1
633-3	TS-1502041	Hex Socket Head Screw	M5x16	1
634	JMD18N-634	Base		1
635A	JMD18-205A	ACME Nut Assembly		1
635-1	JMD18-205	Cross Lead Screw	TM23	1
635-2	BB-51103	Thrust Bearing	51103	2
635-3	JMD18-204	Square Flange		1
635-4	JMD18-202-1	Graduated Dial		1
635-5	JMD18-202	Dial Clutch		1
635-6	JMD18-366	Pin	5x38	1
636	JMD18N-636	Column Base		1
637	JMD18N-637	Rack	600.5L	1
638	JMD18-211	Column Cap		1

Index No.	Part No.	Description	Size	Qty
638-1	TS-0270021	Set Screw	5/16"x5/16"	1
640	JMD18-209	Column Flange Ring		1
641	JMD18-641	Hex Socket Cap Bolt	5/8"x2-1/2"	5
642	TS-0720131	Lock Washer	5/8"	5
643	TS-0208022	Hex Socket Head Screw	5/16"x1/2"	2
644	JMD18N-644	Lock Washer	5/16"	3
645	JMD18N-645	Plug	PT1/4"x3/8"	1
646	365534	Vise		1
647	365534-01	Hardware Package (Bolt, Nut, and Washer)		2

13.5.1 JMD-18PFN Power Feed Assembly – Exploded View

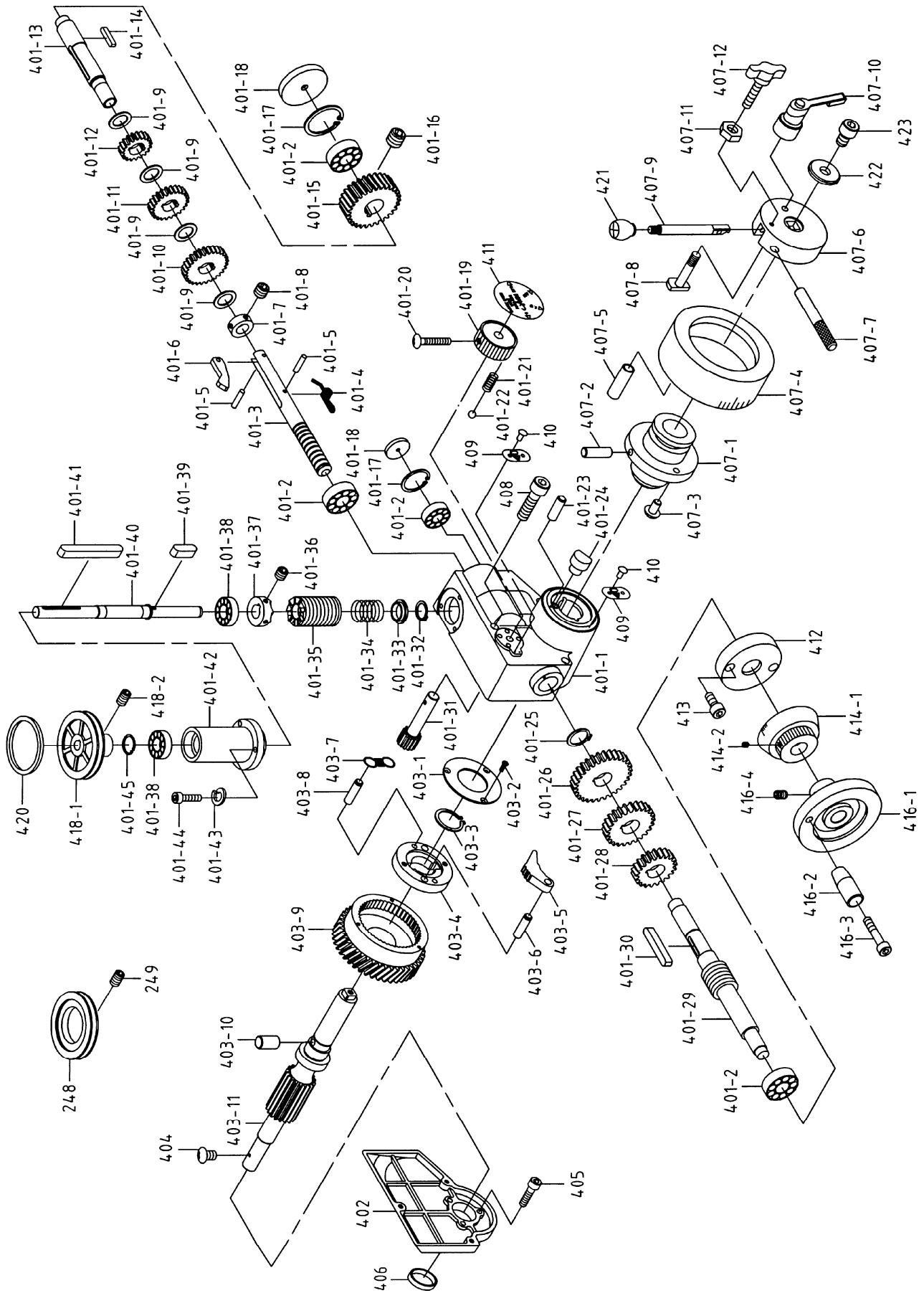

13.5.2 JMD-18PFN Power Feed Assembly – Parts List

Index No.	Part No.	Description	Size	Qty
248	290111	Main Pulley		1
249	JMD18PFN-249	Set Screw	1/4"x3/8"	2
	291022AS	Complete Gear Box Assembly		1
401-1	291022A	Gear Box		1
401-2	BB-6003ZZ	Bearing	6003ZZ	4
401-3	2450082A	Change Gear Lever		1
401-4	2450084B	Tension Spring		1
401-5	JMD18PFN-360	Pin		2
401-6	2450083A	Stop		1
401-7	2450089A	Collar		1
401-8	TS-1523011	Set Screw	M6x6	2
401-9	2450074A	Spacer		4
401-10	2450072A	Gear		1
401-11	2450071A	Gear		1
401-12	2450070A	Gear		1
401-13	291026A	Shaft		1
401-14	JMD18PFN-269	Key	5x5x25	1
401-15	291047	Worm Gear		1
401-16	TS-1523011	Set Screw	M6x6	2
401-17	JMD18PFN-282	C-Ring	R35	2
401-18	2450014	Cover		2
401-19	2450079	Speed Knob		1
401-20	JMD18PFN-303	Round Head Screw	M4x25	1
401-21	290089	Spring		1
401-22	SB-5/16	Steel Ball	5/16"	1
401-23	2450051	Pin		1
401-24	2450020	Release Block		1
401-25	JMD18PFN-373	C-Ring	S19	1
401-26	2450077A	Gear		1
401-27	2450076A	Gear		1
401-28	2450075A	Gear		1
401-29	291028A	Transmission Worm		1
401-30	JMD18PFN-358	Key	5x5x32	1
401-31	291027A	Pinion		1
401-32	JMD18PFN-369	C-ring	S15	1
401-33	2450057	Bushing		1
401-34	2450054	Spring		1
401-35	291046	Worm Shaft		1
401-36	TS-1523011	Set Screw	M6x6	2
401-37	291050	Clutch Block		1
401-38	BB-6003ZZ	Ball Bearing		2
401-39	JMD18PFN-262	Key	5x5x10	1
401-40	291023A	Transmission Shaft		1
401-41	JMD18PFN-389	Key	5x5x45	1
401-42	291024A	Bearing Housing		1
401-43	TS-0720071	Lock Washer	1/4"	3
401-44	TS-0207041	Hex Socket Cap Screw	1/4"x3/4"	3
401-45	JMD18PFN-255	C-Ring	S17	1
402	291032A	Base		1
	291029AS	Complete Worm Gear Assembly		1
403-1	2450048	Worm Gear Cover		1
403-2	JMD18PFN-346	Flat Cross Head Screw	M4x4	3
403-3	JMD18PFN-320	C-Ring	S25	1
403-4	2450024	Clutch Gear Case		1
403-5	2450026	Clutch Key		2
403-6	2450025	Clutch Key Pin		2

Index No.	Part No.	Description	Size	Qty
403-7	2450028	Spring		2
403-8	2450027	Spring Pin		2
403-9	2450023	Worm Gear		1
403-10	2450022	Key		2
403-11	291029A	Pinion Shaft		1
404	JMD18PFN-250	Flat Head Screw	3/16"x3/8"	1
405	TS-0208061	Hex Socket Cap Screw	5/16"x1-1/4"	3
406	291049	Bearing Spacer		1
	291030AS	Complete Clutch Bushing Assembly		1
407-1	291030A	Clutch Bushing		1
407-2	2450030	Bushing Pin		1
407-3	2450031	Bushing Stop		1
407-4	2450032A	Scale Base		1
407-5	JMD18PFN-326	Pin		1
407-6	2450037	Hub		1
407-7	2450039	Pin		2
407-8	2450033	Scale Base Set Screw		1
407-9	2450038	Handle Rod		2
407-10	2450063	Graduated Base Handle		1
407-11	H02050	Hex Nut	5/16"	1
407-12	JMD18PFN-407-12	Set Screw	5/16"x3/4"	1
408	JMD18PFN-350	Hex Socket Cap Screw	5/16"x3-1/2"	3
409	2450060	Pointer		2
410	JMD18PFN-309	Rivet		4
411	JMD18PFN-354	Speed Scale		1
412	6145	Worm Cover		1
413	JMD18PFN-376	Hex Socket Cap Screw	3/16"x3/8"	2
414-1	291051A	Micro Adjusting Indicator		1
414-2	TS-0267031	Set Screw	1/4"x5/16"	1
	6142-2S	Complete Wheel Assembly		1
416-1	6142-2	Hand Wheel		1
416-2	6580	Handle		1
416-3	6581	Handle Screw		1
416-4	TS-0270021	Set Screw	5/16"x5/16"	1
418-1	290110	Sub-Pulley		1
418-2	TS-0267031	Set Screw	1/4"x5/16"	1
420	JMD18PF-114	Belt		1
421	290086	Knob		2
422	2450040	Washer	M8	1
423	TS-1504031	Hex Socket Cap Screw	M8x16	1
	291001-CPN	Gear Box Assembly Complete		1

14.0 Electrical Connections

14.1 Wiring Diagram: JMD-15 Only

110V

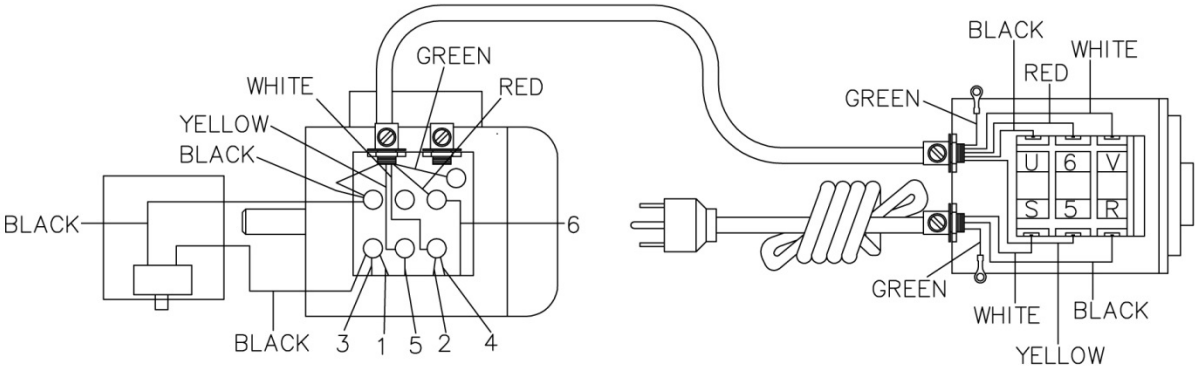

220V

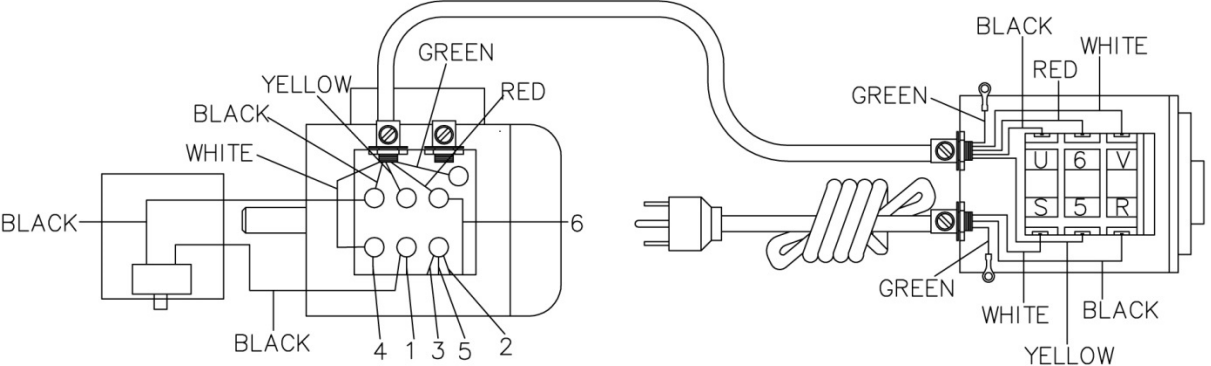

14.2 Wiring Diagram: JMD-18 Only

115V

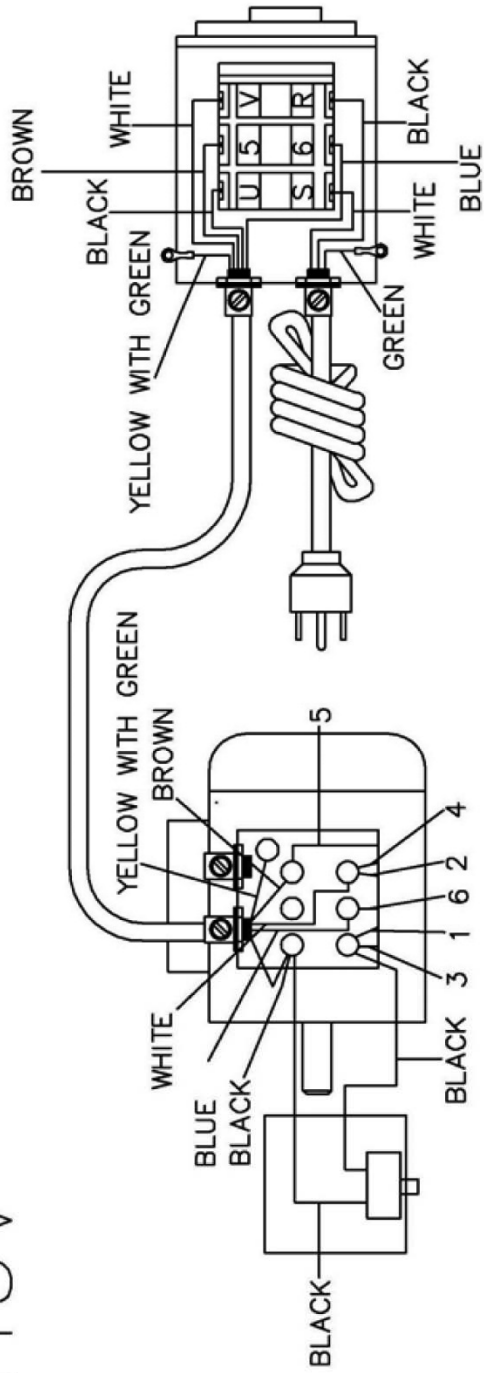

230V

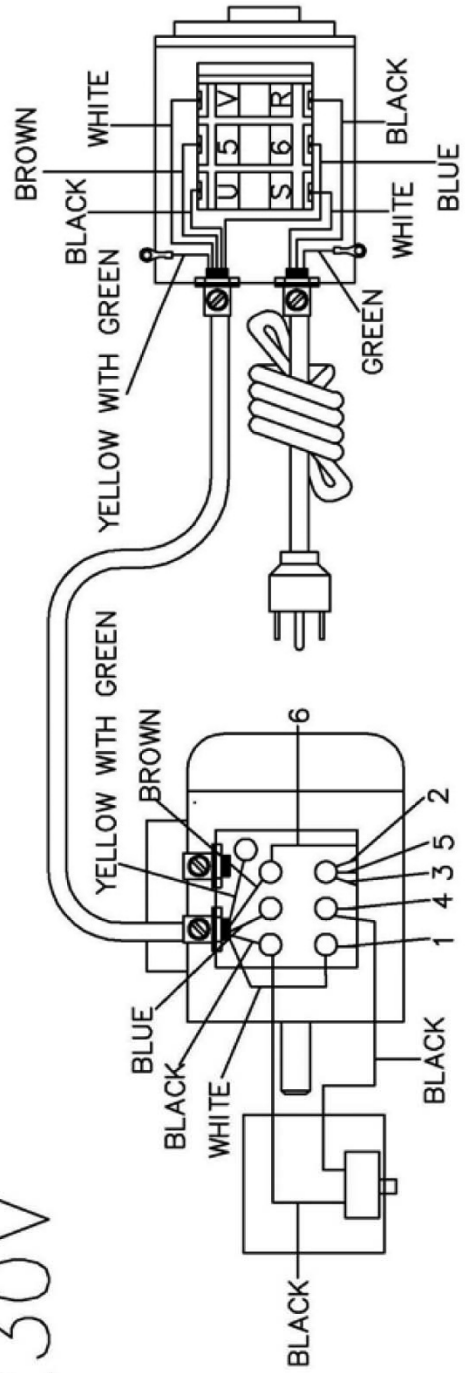



427 New Sanford Road
LaVergne, Tennessee 37086
Phone: 800-274-6848
www.jettools.com