



**STABILA**  ...sets standards





## How We Define Ourselves.

**We** are a German manufacturer of specialty measuring and layout tools.

Our products are the preferred choice of professionals throughout the world.

Precision measuring tools perform faster, easier and create more profit.

All of our tools are factory tested and durable; built to handle real world job site conditions while providing craftsmen with the dependability and consistent accuracy they expect and deserve.





## **Commitment to Accuracy.**

### **STABILA Tolerances**

All accuracy tolerances stated by Stabila are absolute values. Stabila products will never perform below their stated accuracy.

## **WARRANTY**

### **SPIRIT LEVELS:**

STABILA levels will maintain their stated accuracy for life. The vials on all STABILA levels will not fog, leak or become inaccurate. If they do, you will be given a new level. Original purchase receipt required. Damaged frames void warranty.

### **LASERS and TECH LEVELS:**

We will repair, without charge, any defects due to faulty materials or workmanship for 2 years from date of purchase. Original purchase receipt required.  
**48 Hours Service Turnaround Time.**

### **ACCESSORIES:**

Tape Measures, Tripods, Cases, Grade Rods, Etc.  
30 day warranty against manufacturer defects from the date of purchase. Proof of purchase required.



STABILA  ...sets standards

# BEAM



\* Top Read View



**Strength:**



**+120%**



**Stability:**



1



**Precision: 3 Straight Edges**

2



**Grip: Continuous Handle**



**Finish: Fender Smooth**



## TYPE 300

CAT. #	LENGTH
41024	24" R-Beam
41032	32" R-Beam
41048	48" R-Beam
41072	72" R-Beam
41078	78" R-Beam
41096	96" R-Beam
20080	R-Beam Endcaps



**EPOXY-LOCKED VIALS**



**GUARANTEED FOR LIFE**

STABILA levels are manufactured to metric dimensions. All stated level lengths in this catalog are "soft" conversions.

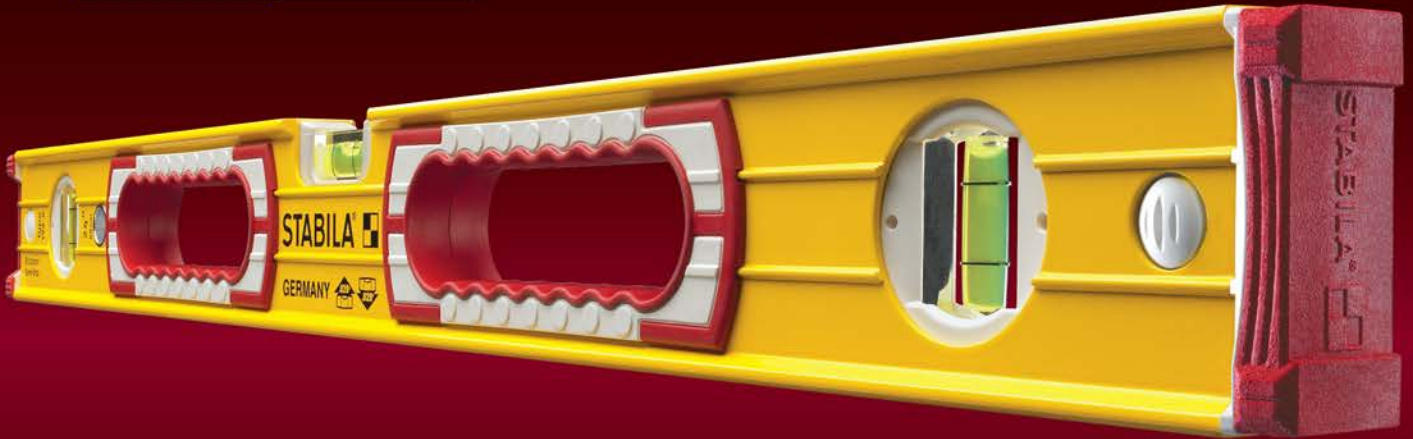

- Unique vial design: bright, easy to read.
- Vials will not leak, break or fog.
- Dual material handholes for comfort and grip.
- Shock-absorbing endcaps: prevent slipping, removable to carry lines tight into corners.
- Electrostatic enamel finish: baked on tough, cleans up with water and brush.



Vials read the same in all positions

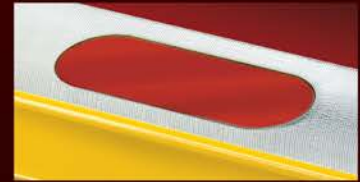

Try to pull our magnetic levels off steel without twisting your wrist

## TYPE 196

CAT. #	LENGTH
37416	16" 1 Plumb Vial, 1 Handhole
37424	24" Handholes
37432	32" Handholes
37436	36" Handholes
37448	48" Handholes
37459	59" Handholes
37472	72" Handholes
37478	78" Handholes
37524	59" plus 24" Handholes
37532 Jamber Set®	78" plus 32" Handholes
37496 (Type 96)	96" without Handholes

## TYPE 96M MAGNETIC

CAT. #	LENGTH
38616	16" without Handholes
38624	24" without Handholes
38632	32" without Handholes
38636	36" without Handholes
38648	48" Handholes
38659	59" without Handholes
38672	72" Handholes
38678	78" Handholes
38532 Mag. Jamber Set®	78" plus 32"
38696	96" without Handholes



**EPOXY-LOCKED VIALS**



**GUARANTEED FOR LIFE**

Levels 59" and longer have a bridge over the horizontal vial for increased frame strength and uninterrupted scribing. STABILA levels are manufactured to metric dimensions. All stated level lengths in this catalog are "soft" conversions.

# TECH

**IP 65**  
DUST & WATERPROOF



- Modes: degree, percent; inches in decimal, fractions and mm/m
- 2 displays light up
- Dust and waterproof. Classification: (IP65)
- Simple water and brush clean-up
- Correct read upside down
- Shock-absorbing endcaps; removable to carry lines tight into corners

## TYPE 196-2

CAT. #		LENGTH
36514	TECH Level with Case	14"
36524	TECH Level with Case	24"
36548	TECH Level with Case	48"

Type 196-2:  
14" horizontal vial, no handgrip  
24"/48" horizontal vial, two vertical vials, one handgrip

Measuring accuracy of the vials: In normal position  $0.029^\circ = 0.5 \text{ mm/m}$   
Overhead measurement  $0.029^\circ = 0.5 \text{ mm/m} - 0.029^\circ = 1/32"$  over 72"  
Electronic accuracy: at  $0^\circ$  and  $90^\circ = \pm 0.05^\circ$ , from  $1^\circ$  to  $89^\circ = \pm 0.2^\circ$   
2 AA Batteries included.

## TYPE 96M-2 MAGNETIC

CAT. #		LENGTH
36520	Magnetic TECH Level with Case	24"
36540	Magnetic TECH Level with Case	48"

Type 96M-2:  
24" horizontal vial, one vertical vial, no handgrips  
48" horizontal vial, two vertical vials, one handgrip



**EPOXY-LOCKED VIALS**







**GUARANTEED FOR LIFE**

# TECH

**IP 65**  
DUST & WATERPROOF



- 1**  On/Off
- 2** Mode: Select: degrees, percent, rise and run in both inch and metric. Displays decimal or fractional readings.
- 3** Cal: Calibration Button.
- 4** Hold: Temporarily save the current measurement on the screen.
- 5** Ref: Set any angle/slope as "0.00"
- 6**  Illuminates displays.
- 7**  Key-Lock: Select a mode and lock it in. Block and lockout the other modes.
- 8**  Sound Control: The flat tone indicates "Level". Position materials using sound when displays and the vial are out of view.





# Mason LEVELS



- A** Designed to be HIT with a Trowel. Patented "Dead Blow Shield" protects the frame and transfers the energy from the trowel hit to the work surface.
- B** Top mounted horizontal vial for visibility, minimizes bending over.
- C** Vertical vial right where you want it.



- Frame will not warp or twist
- Water and brush clean-up
- Level accuracy guaranteed for life; vials will never fog, leak or require adjustment

## TYPE 196-2K

CAT. #	LENGTH
36416	16" without Handholes
36424	24" without Handholes
36436	36" Handholes
36448	48" Handholes
48196	48 COMPLETE Mason's Set: 48" - 24" - Torpedo and Case



**Easy Clean Up**



**EPOXY-LOCKED VIALS**



**GUARANTEED FOR LIFE**

STABILA levels are manufactured to metric dimensions. All stated level lengths in this catalog are "soft" conversions.



# These Vials Light Up

*\* Click On and See The Light*



- Two removable Light Paks switch on and off
- Wide vial housing for increased vial view
- Dual material handholes for comfort and grip
- Shock-absorbing endcaps

## TYPE 196LED

CAT. #	DESCRIPTION
39324	24" Lights Level with 2 Light Paks
39340	48" Lights Level with 2 Light Paks
20090	Replacement Light Paks (2)

Auto shut off after 100 seconds  
 8 hours of constant run battery life  
 Uses one AAA battery  
 Bulb type: LED

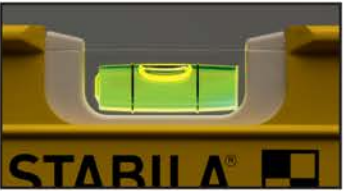

**Level**

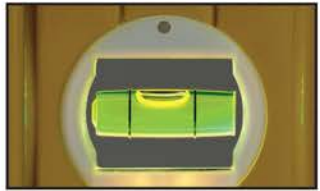

**Plumb**



**Two Removable Light Paks**



**EPOXY-LOCKED VIALS**



**GUARANTEED FOR LIFE**

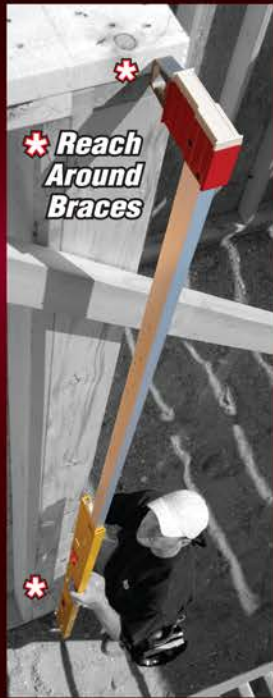

\* Reach Around Braces



Simply twist-on to add Stand-Offs



## TYPE 106T

CAT. #	LENGTH
35610	6' - 10'
35712	7' - 12'
33000	Maintenance Kit
33100	Replacement Stand-Offs

- Strong re-enforced frame
- Plumb vial always at eye level
- Opposite side is a measuring surface and straight edge
- Scale on both sides of extension for FAST Set-ups: 8'-1", 9'-1", 10'-1" etc.

106T: Removable 1 5/8" Stand-Offs



## TYPE 106TM MAGNETIC

CAT. #	LENGTH
34610	6' - 10' Magnetic
34712	7' - 12' Magnetic
33000	Maintenance Kit

106TM: Strong Flush Mounted Magnets Grab Steel - Hands-Free Operation



EPOXY-LOCKED VIALS



GUARANTEED FOR LIFE

STABILA  ...sets standards

# XTL

**48" → → 79"**  
#35479



**NEW**

**26" → → 40"**  
#35240

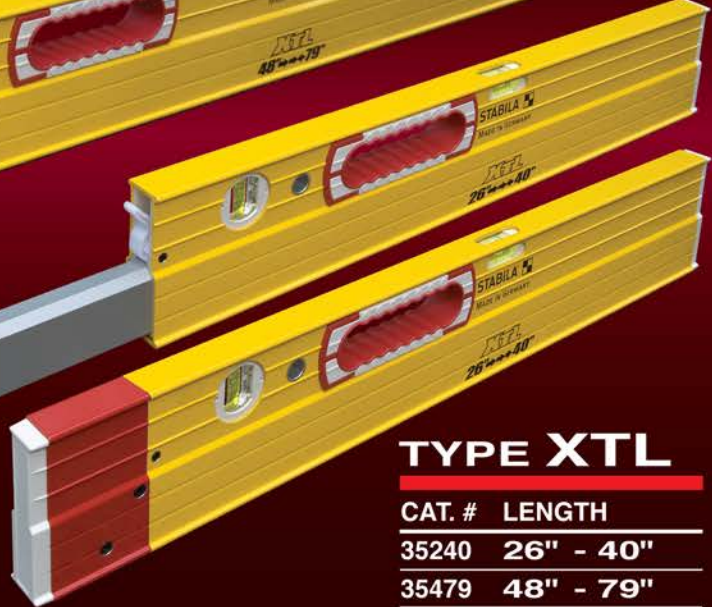

## TYPE XTL

CAT. #	LENGTH
35240	26" - 40"
35479	48" - 79"
33000	Maintenance Kit

- XTL-26 expands to the size of all common door headers and sills
- XTL-48 can double as your jamb level and accurately handle all window and door sizes up to 79"
- XTL's wide frame design makes the plumb vial easy to read plus in the extended position, the level is locked-in tight and accurate



## Exact Length



30065 Both XTLs and Multi-Pocket XTL Case



**EPOXY-LOCKED VIALS**



**GUARANTEED FOR LIFE**

STABILA  ...sets standards

# THE MEASURING STICK

Rehab • Remodel • Restore

**NEW**



## TYPE 80A-2

CAT. #	LENGTH
29124	24" The Measuring Stick (60cm)
29148	48" The Measuring Stick (120cm)
20035	The Measuring Stick end caps (2)

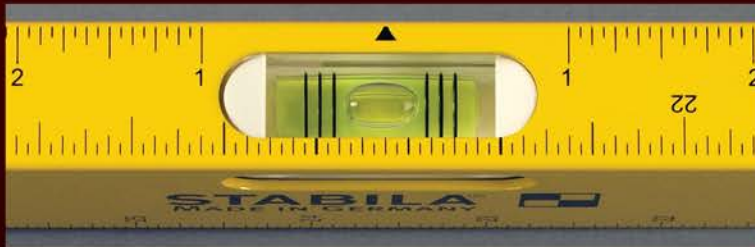

Double Bridge Frame • Slope Indication Rings



3 Layout Scales

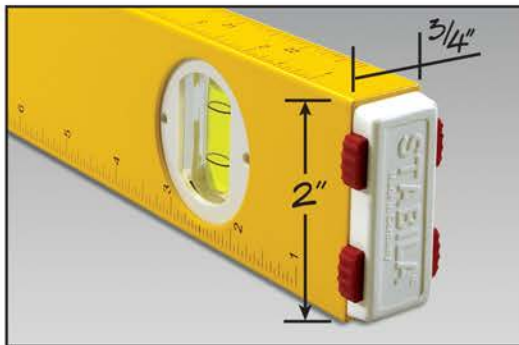

Double Sided Wall Grips



EPOXY-LOCKED VIALS



GUARANTEED FOR LIFE



• **Easy to Grip** • **Easy to Read** • **Easy to Clean**

- **STABILA's general construction level.**  
*Perfect for tile installers and all jobsite applications.*
- Rugged, takes rough handling
- Certified accuracy in normal reading positions: 1/32" over 72"
- Level accuracy guaranteed for life; vials will never fog, leak or require adjustment

## TYPE 80A-2

CAT. #	LENGTH
29024	24"
29048	48"
29072	72"
29824	ProSet 48", 24", & Torpedo

## TYPE 80A-2M MAGNETIC

CAT. #	LENGTH
29224	24" Magnetic
29248	48" Magnetic
29272	72" Magnetic
29924	Magnetic ProSet 48", 24", & Torpedo

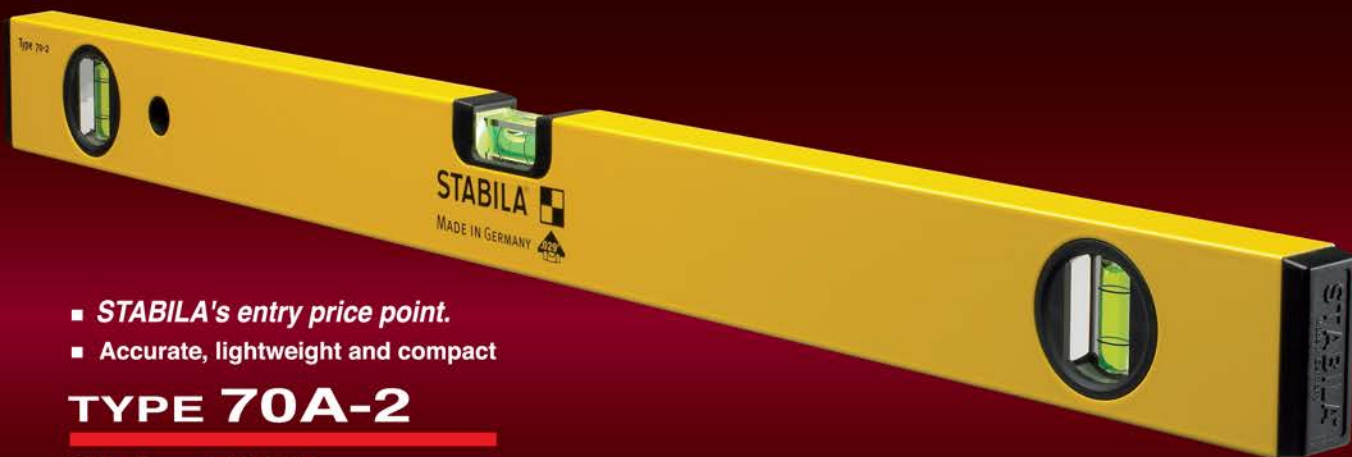

- **STABILA's entry price point.**
- Accurate, lightweight and compact

## TYPE 70A-2

CAT. #	LENGTH
22924	24"
22948	48"



**EPOXY-LOCKED VIALS**



**GUARANTEED FOR LIFE**

STABILA levels are manufactured to metric dimensions. All stated level lengths in this catalog are "soft" conversions.



25245



25245

25360

## DIE-CAST TORPEDO LEVELS

CAT. #		LENGTH
25010	2 Vial, non Magnetic (not shown)	10"
25100	2 Vial, Magnetic (not shown)	10"
25245	3 Vial, 45° w. "V-Groove", Magnetic	10"
25360	3 Vial, 360° w. "V-Groove", Magnetic	10"
30003	Heavy-duty black holster	

- Big, bright, precise, easy to read vials
- *Magnetic - Try to pull them off steel without twisting your wrist.*
- Heavy-duty, die-cast frame
- Certified accuracy in normal reading positions: 1/32" over 72"
- Level accuracy guaranteed for life; vials will never fog, leak or require adjustment
- 1/8" & 1/4" per ft. Grade Rings on 25245 & 25360



11901



11990



11901



11927

- STABILA's PRO quality in a small format
- Great for all trades
- Big, bright, easy to read vial
- Handy - Light - Precise
- Magnetic bar for horizontal & vertical hold (11901)

## POCKET LEVELS

CAT. #		SIZE
11990	Magnetic	1 5/8" x 2 5/8"
11985	Non-Magnetic (not shown)	1 5/8" x 2 5/8"
11901	PRO Magnetic with Holster	1 5/8" x 2 5/8"
11927	Quick Check (Pocket PRO & 27' Tape Measure)	

STABILA  ...sets standards

# OFF ROAD LAYOUT SYSTEM

**DE-TECH**  
Digital Receiver



Patented: **"SPS"**

**Shock Protection System**

**MADE IN GERMANY**

5°  
5°

*Vertical (left & right)*

**Square**



Fully Automatic

# INTERIOR / EXTERIOR LAYOUT SYSTEM

Self-Leveling, Rotating

**OFF ROAD**  
LAYOUT SYSTEM

- Durable: Takes a 6' Drop
- Range: 1,100 ft. / 350m
- Horizontal, Vertical, Square
- Variable Speed Rotation
- Accuracy:  $\pm 1/8''$  over 100'  $\pm 0.1$  mm/m
- High Alert Shut Off Function
- Dust and Water Proof - IP65
- Rubber Exterior Over Metal Housing
- Shock Absorbing Interior

## DE-TECH Digital Receiver

*Defined Elevation to the 1/16"*



### 05600 LAR250 OFF-ROAD Fully Loaded Layout Laser System

Includes (as shown): LAR250 Rotating Laser, DE-TECH Receiver, Remote Control, Wall Mount, Magnetic Target Plate, 10" - 110" Elevator Tripod with Ground Kit, Hi/Lo Elevation Rod, Batteries 2xD, Manual and Hard Shell Case.

### 05610 LAR250 OFF-ROAD Layout Laser Kit

Includes: LAR250 Rotating Laser, DE-TECH Receiver, Remote Control, Wall Mount, Magnetic Target Plate, Batteries 2xD, Manual and Hard Shell Case. (Elevator Tripod with Ground Kit and Hi/Lo Elevation Rod not included)

### 07430

- Easily Readable Digital Display Shows Exact Distance from Grade
- Arrows Show Direction to Grade
- 4" Laser Reception Window
- Dust & Water Proof - IP 67
- Takes a 10' Drop
- Volume selection

## TYPE LAR250

Catalog #	Self-Leveling Range	Diameter Receiver Range	Accuracy Rating	Batteries	Battery Life
05600 & 05610	$\pm 5^\circ$	1,150' / 350m	$\pm 1/8'' @ 100' / \pm 0.1$ mm/m	2 x D	Approx. 120 hours
07465 Wall Mount	07430 DE-TECH Receiver	08590 Elevator Tripod with Ground Kit	07468 Elevation Rod	07474 Target Plate	





STABILA



...sets standards

**MADE IN GERMANY**

- **1 Button Simple**
- **Horizontal Only**

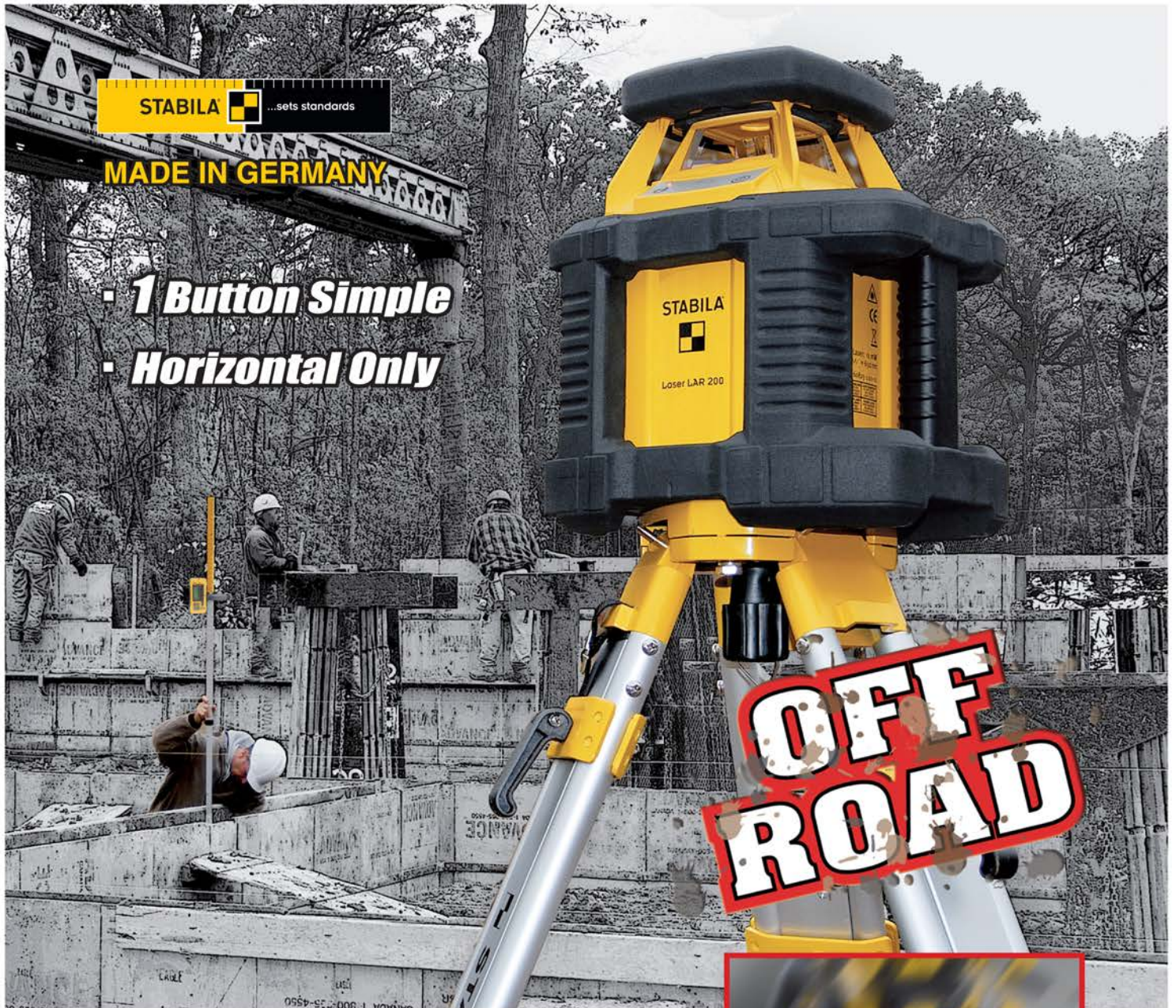

**OFF ROAD**

**Fully Automatic  
EXTERIOR  
LASER SYSTEM  
Self-Leveling - Rotating Laser**

**05500** - Fully Loaded System

**05510** - Laser Kit

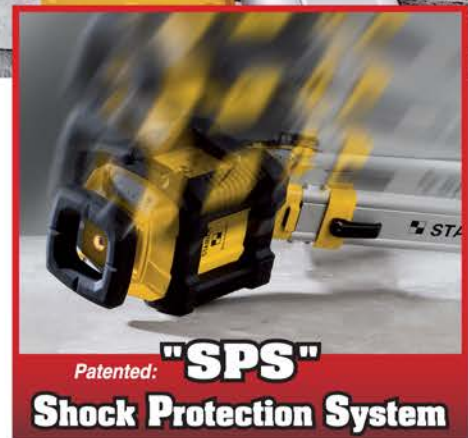

Patented:

**"SPS"**

**Shock Protection System**

- Durable: Takes a 6' Drop
- Range: 1,800 ft. / 550m
- Rotation Speed: 600 rpm
- One Button Operation
- Self Leveling Working Range:  $\pm 5^\circ$
- Accuracy:  $\pm 1/8"$  over 100' /  $\pm 0.1$  mm/m
- Temp. Resistant:  $14^\circ$  to  $140^\circ$  F ( $-10^\circ$  C to  $+60^\circ$  C)
- Rubber Exterior Over Metal Housing
- Shock Absorbing Interior
- Dust and Waterproof - IP65
- Battery Life: up to 120 hours

Fully Automatic  
**EXTERIOR LASER SYSTEM**  
 Self-Leveling - Rotating Laser



**OFF ROAD**



**MADE IN GERMANY**



**DE-TECH**  
**Laser Receiver**

*Defined Elevation  
 to the 1/16"*

**07430**

- Digital Read-Out Shows Exact Distance from Grade
- Arrows Show Direction to Grade
- 4" Reception Band
- Dust & Water Proof - IP 67
- Takes a 10' Drop



**05500** - Fully Loaded System

**05510** - Laser Kit

**05500 LAR200 OFF-ROAD Laser System**

Includes: LAR200 Rotating Laser, DE-TECH Receiver with Clamp, Fixed Head Tripod, Hi/Lo Elevation Rod, Batteries 2xD, Manual & Hard Shell Case.

**05510 LAR200 OFF-ROAD Laser Kit**

Includes: LAR200 Rotating Laser, DE-TECH Receiver with Clamp, Batteries 2xD, Manual & Hard Shell Case.

(Fixed Head Tripod & Hi/Lo Elevation Rod not included)

**TYPE LAR200**



Catalog #	Self-Level Range	Dia. Receiver Range	Accuracy Rating	Rotation Speed	Tripod Mount	Battery Life
05500 & 05510	5°	1,800' / 550	± 1/8" @ 100' / ± 0.1mm/m	600 rpm	5/8"-11	Approx. 120 hours
07430 DE-TECH Receiver		07498 Fixed Head Tripod		07468 Hi/Lo Elevation Rod		

STABILA  ...sets standards

Fully Automatic  
**INDOOR LASER SYSTEM**  
Self-Leveling, Rotating

**Green Beam**

**LASER**

**05300**

**5X**  
Visibility  
Indoors

**MADE IN GERMANY**



**NEW**

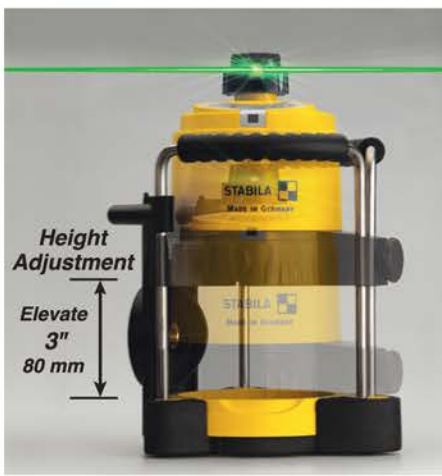

**05300 LAR120G System**

Includes: Indoor Laser, Remote Control, Long Range Receiver, Wall Mount Bracket, Magnetic Target Plate, Batteries, and Carrying Case.

**TYPE LAR 120G**

**DANGER**  
LASER RADIATION  
AVOID DIRECT EYE EXPOSURE  
MAXIMUM OUTPUT POWER  
<5mW @ 632nm  
CLASS IIIa LASER PRODUCT

Cat. #	Self-Level Range	Leveling Accuracy Rating	Indoor Visible Beam Range	Dia. Receiver Range	Scanning Line Lengths	Rotation Speeds	Tripod Mount	Batteries
05300	5°	± 1/8" @ 100' / ± 0.1mm/m	± 132' / 40m	980' / 300m	Variable	Variable	5/8" - 11	18 hours, 2xD

STABILA  ...sets standards

# ResCon

Residential Construction & Concrete

**05155**

*Easy to use  
Receiver Slide*



**Self-Leveling, Rotating**



- Range: 600' with Receiver (180m)
- Easy Control Pad
- Rotation horizontal and vertical, 3 stage scan, plumb line, 90° angle
- FAST self-leveling with pendulum technology
- Protective metal roll cage; shock absorbing rubber
- Pendulum protected during transport
- Dust and water rating (IP 54)

*Quickly change from  
horizontal to vertical*



## 05155 ResCon Laser System

Includes: LAPR150 Rotating Laser, Receiver with Clamp, Fixed Head Tripod, Hi/Lo Elevation Rod, Target Plate, 2D 1.5V Batteries, Hard Shell Case

## TYPE LAPR150

Cat #	Self-Level Range	Dia. Receiver Range	Accuracy Horizontal	Accuracy Vertical	Tripod Mount	Battery Life
05155	5°	600' / 180m	± 1/4" @ 100' / ± 0.2mm/m	± 5/16" @ 100' / ± 0.3mm/m	5/8"-11	80 hours
07460 Receiver	07498 Fixed Head Tripod	07468 Hi/Lo Elevation Rod				





**03360**

- Very bright, very crisp laser lines and dot
- 360° horizontal line
- Two vertical lines at 90° angle
- **MANUALALIGNMENT** fine adjustment knob pivots the right angle left and right
- Plumb down dot/ point
- Built-in vertical elevation height adjustment
- The laser can be pivoted 360° inside the housing
- Pulsed laser lines for use with optional receiver (#07330)



**03360 ProLiner Multi-Line Laser Kit**

Includes: LAX400 Laser, Target Plate, Wall Bracket, Laser Glasses, Batteries, Manual, Kit Box



- **MANUALALIGNMENT** fine adjustment knob.
- Two adjustable feet enable the laser to align to track.
- 360° horizontal line covers entire room.
- The magnetic "V-Groove" sticks to the wall bracket.

**TYPE LAX400**

Cat. #	Self-Leveling Range	Leveling Accuracy	Line Straightness	90° Angle Precision	Laser Beam Accuracy	Visible Line	Batteries	Battery Life
03360	Approx. ± 4.0°	± 3/16" @ 50'	± 1/8" @ 50'	± 3/16" @ 50'	± 3/16" @ 50'	60' Indoors	4 x AA	10 Hours



Visible vertical beam behind laser



# ProLiner™

## Cross Line Laser

### Plus Plumb Points

Self-Leveling

**03180**



Framing Base Included

- Thin, sharp and easily visible crossed lines up to 60'
- **Visible vertical beam behind laser**
- Plumb-points up and down
- Range with optional receiver: 300', #07330
- Built-in elevation
- Laser rotates inside housing for built-in protection
- Built in "V-Groove" Magnetic Mount

**03180 ProLiner Cross Line Layout Kit**  
 Includes: LAX300 Laser, Framing Base (#07471),  
 Target Plate, Wall Bracket, Batteries, Manual,  
 Carrying Pouch



## TYPE LAX300

Cat. #	Self-Leveling Range (horizontal)	LEVELING ACCURACY			Batteries	Battery Life
		Up Beam	Down Beam	Level Beam		
03180	± 4.5°	± 3/32" @ 30'	± 1/8" @ 30'	± 3/32" @ 30'	3 x AA	Approx. 20 Hours





- Transfer of 90° angles
- Range of visible beams: 100'
- Plumb points up and down
- Accuracy: ± 3/32" @ 30'

**03160 LaserBob 5 Point Layout Kit**  
 Includes: LA-5P Laser, Framing Base (#07471), Target Plate, Wall Bracket, Batteries, Manual, Carrying Pouch

## TYPE LA-5P

Cat. #	Self-Leveling Range (horizontal)	LEVELING ACCURACY				Batteries	Battery Life
		Up Beam	Down Beam	Level Beam	Square Beam		
03160	± 4.5°	± 3/32" @ 30'	± 1/8" @ 30'	± 3/32" @ 30'	± 1/16" @ 30'	3 x AA	Approx. 20 Hours





STABILA  ...sets standards

# FLS 90

04490

## 50' Square, Solid Lines

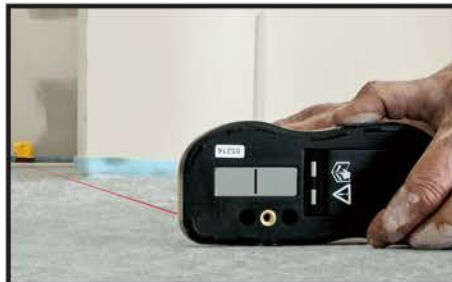

- Compact housing designed to position the tool inside corners to quickly check for square
- Special and patented Stabila optics deliver 50' square, solid lines
- Can be used with Stabila REC210 audio receiver to extend usable range to 490' (07330)
- Unique dual purpose base allows laser to grip tile and transfer 90 degree
- Accuracy within 3/8" @ 100'

04490 FLS 90 LASER KIT  
Includes: Target plate for easier daylight use and belt pouch carrying case.

**CAUTION**  
LASER RADIATION  
DO NOT STARE INTO BEAM  
 CLASS II LASER PRODUCT  
MAXIMUM OUTPUT POWER  
<1mW @ 620nm - 690nm

**DUAL PURPOSE BASE:**  
On tiles position claws downward.  
On flat surfaces position claws upward.

### TYPE FLS 90

Cat. #	Range	90° Accuracy Rating	Batteries	Battery Life
04490	Visual 50'	± 3/16" @ 50'	3x AA	approx. 20 Hours





Measurement Taken  
@ This Laser Point  
Within 1/16"

**NEW**

# LASER MEASURES



## LD520 Laser Measure 06520

- Outdoor, Long Range: 660'
- Camera Target Locator with 4X Zoom
- 360° Inclination Sensor
- Bluetooth capable. Free app "Stabila measure" (Apple products only: iPhone 4S and higher, iPad 2 or greater)
- Integrated Calculator - readings can be added to, multiplied, subtracted from, etc.
- Programmable favorites
- Stores last 30 measurements
- Dust and water protected - IP54
- Carrying case belt pouch

### TYPE LD520

Cat. #	Range	Accuracy	Battery Life	Batteries
06520	660'	± 1/16"	Up to 5,000 measurements	2 x AA



## LD420 Laser Measure 06420

- Working Range: 260'
- \* Measurement from front or back of housing
- Integrated Calculator - readings can be added to, multiplied, subtracted from, etc.
- Constant measuring function
- Classification: IP65
- Bright back-lit screen
- Carrying case belt pouch

### TYPE LD420

Cat. #	Range	Accuracy	Battery Life	Batteries
06420	260'	± 1/16"	Up to 5,000 measurements	2 x AAA

## LD320 Laser Measure 06320

- Working Range: 130'
- \* Measurement from front or back of housing
- Constant measuring function
- Impact resistant housing
- Bright back-lit screen
- Carrying case belt pouch



### TYPE LD320

Cat. #	Range	Accuracy	Battery Life	Batteries
06320	130'	± 3/32"	Up to 3,000 measurements	2 x AAA



**07350**



**NEW**



**RADIO FREQUENCY  
"RF"  
AUTOALIGNMENT**

## TYPE REC410 Line RF Receiver

- **AUTO ALIGNMENT:** the receiver uses radio to control the LA180L multi-line laser
- Integral remote radio operation up to 160'
- Acoustic and visual guidance onto the target: the visual guidance is initially supplemented by a LED display
- Working leveling range of 300'

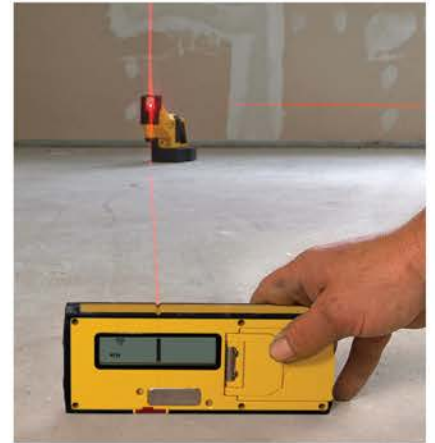

**07430**



**D-E-TECH  
Laser Receiver**  
*Defined Elevation  
to the 1/16"*

- Digital Read-Out Shows Exact Distance from Grade
- Arrows Show Direction to Grade
- 4" Reception Band
- Dust & Water Proof - IP 67
- Takes a 10' Drop



## Receivers

CAT. #	DESCRIPTION
07330	Receiver and bracket for line lasers (03180, 03269, 03270, 03275)
07460	Receiver and bracket for rotating lasers (05000, 05155, 05200, 05100)

STABILA ...sets standards



Grit Resistant Coating



## TAPE MEASURES



Scale on 2 sides



Grip Hook



Rocker Blade Lock

## TYPE BM40

CAT. #	LENGTH	CAT. #	LENGTH
30316	16' Tape	30416	5 meter / 16' Tape
30327	27' Tape	30427	8 meter / 27' Tape
30333	33' Tape	30433	10 meter / 33' Tape

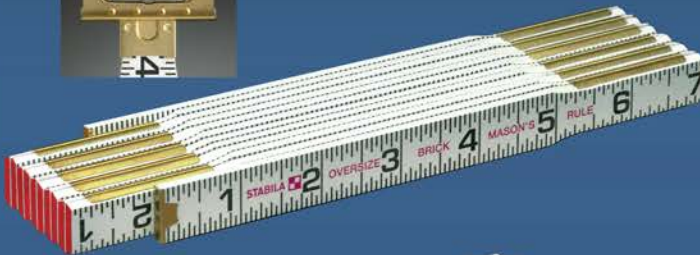

## FOLDING RULES

- Hardened steel springs and steel joints
- Fully sealed rivets with abrasion protection

## TYPE 600

CAT. #	DESCRIPTION
80001	Mason's (1/16ths - both edges - outside)
80005	Oversize Brick (1/16ths - both edges - outside)
80010	Modular Spacing (1/16ths - both edges - outside)
80015	Engineer's (1/16ths, 1/10ths, 1/100ths)



## Elevator Tripod

CAT. #	LENGTH
08560	27" - 66"

- Removable tripod head
- Tripod legs with spikes
- Rubber shoes, scratch-free indoors
- Spread stopper chain
- Laser descends slowly when column is unlocked

## Elevator Tripod with Ground Kit

CAT. #	LENGTH
08590	46" - 112"

## Fixed Head Tripod (not shown)

CAT. #	LENGTH
07498	36" - 68"



33100



20065



20070



20090

7' (213cm)



## Replacement Parts and Accessories

CAT. #	DESCRIPTION
20015	80A-2 series level Endcaps (2)
20025	80A-2 Pro-Frame level Endcaps (2)
20035	Measuring Stick level Endcaps (2)
20040	70A-2 series level Endcaps (2)
20060	Plate Level series Endcaps (2)
20065	Plate Level 2 series Endcaps (2)
20070	196 / 96M series level Endcaps (2)
33000	Plate Level Maintenance Kit
33100	Plate Level 2 Stand-Offs (2)
07465	Wall Mount Bracket with fine adjustment Fits: 05600, 05200 and 05000 Lasers
07470	Laser Enhancement Glasses
* 07471	Solid "Framing" base for #03160/#03180 pouch lasers, page 22 and 23
07474	Ceiling Target Plate
20080	R-Beam Endcaps (2)
20090	Light Paks with Batteries (2)

## +/- Hi/Lo Elevation Rod

- Yellow inch scale with 1/8" increments
- Red cm scale with mm increments

CAT. #	LENGTH
07468	52" - 7' (Imperial and 10ths)
07469	52" - 7' (Imperial and metric)

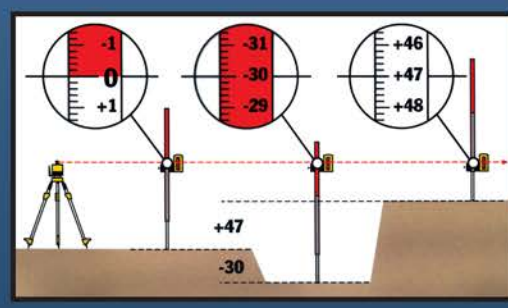

## Carrying Cases

CAT. #	LENGTH
30003	Holster for Torpedo (25010, 25100, 25245, 25360)
30015	48", 32", 24", 16" and Torpedo
30025	78", 59", 32", 24", 16" and Torpedo
30030	96" Level
30035	7' - 12' Plate Level Plus 59", 36"
30045	6' - 10' Plate Level Plus 59", 36"
30059	59", 32", 24", 16" and Torpedo
30065	GO PACK Carrying Case for XTL levels, page 11



30003

\* 07471



30025

[stabila.com](http://stabila.com)

Date Code: 01.15

STABIL A, INC., 332 Industrial Dr., P.O. Box 402, South Elgin, IL 60177-0402

Phone: 800.869.7460 ■ In IL: 847.488.0050 ■ Fax: 847.488.0051 ■ E-Mail: [custservice@stabila.com](mailto:custservice@stabila.com)