

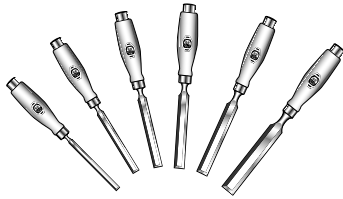

### Chisel Sets Wooden Handles



Two different sets of high quality Two Cherries bevel edge chisels with hardwood handles. The set of six chisels consists of sizes 6-10-12-16-20-26mm, the set of four consists of 10-16-20-26mm.

- 500-1562 ..... Set of Six
- 500-1564 ..... Set of Four

### Chisel Sets Plastic Handles

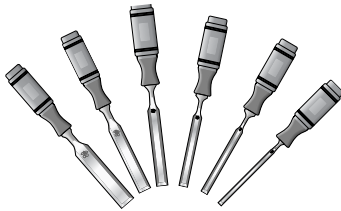

Two different sets of high quality Two Cherries bevel edge chisels with cellulose acetate plastic handles. The set of six chisels consists of sizes 6-10-12-16-20-26mm and the set of four consists of 10-16-20-26mm.

- 500-3562 ..... Set of Six
- 500-3564 ..... Set of Four

### Bevel Edge Chisels

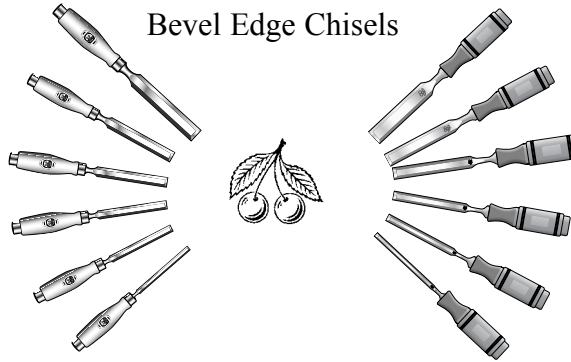

These chisels are made of the highest quality German steel. Carefully made, polished all-around. One of the finest tools made in the world! Ten to fourteen inches in overall length. Choose between a traditional and well proportioned wooden handle, or nearly unbreakable cellulose acetate plastic handle. A number of sets are available which include the most important sizes. Inch sizing is approximate.

Carefully forged blades are skillfully heat treated in an immersion bath method to achieve a Rockwell hardness of 61° C. This means that sharpening the chisels may take a few extra minutes, but they will hold an edge significantly longer than almost any other chisels! After heat treating, the blades are polished to a rich finish that makes them a joy to use. Fitting appropriate handles is the final step in producing these highest quality German chisels.



#### Wooden Handled Chisels

500-1502 ..... 2 mm	500-1520 ..... 3/4" ..... 20 mm
500-1503 ..... 1/8" ..... 3 mm	500-1522 ..... 22 mm
500-1504 ..... 3/16" ..... 4 mm	500-1524 ..... 24 mm
500-1506 ..... 1/4" ..... 6 mm	500-1526 ..... 26 mm
500-1508 ..... 8 mm	500-1528 ..... 28 mm
500-1510 ..... 3/8" ..... 10 mm	500-1530 ..... 1 1/4" ..... 30 mm
500-1512 ..... 1/2" ..... 12 mm	500-1532 ..... 32 mm
500-1514 ..... 14 mm	500-1535 ..... 35 mm
500-1516 ..... 5/8" ..... 16 mm	500-1540 ..... 1 1/2" ..... 40 mm
500-1518 ..... 18 mm	500-1545 ..... 45 mm
	500-1550 ..... 2" ..... 50mm



#### Plastic Handled Chisels

500-3502 ..... 1/8" ..... 2mm	500-3512 ..... 1/2" ..... 12mm
500-3504 ..... 3/16" ..... 4mm	500-3516 ..... 3/8" ..... 16mm
500-3506 ..... 1/4" ..... 6mm	500-3520 ..... 1/4" ..... 20mm
500-3510 ..... 3/8" ..... 10mm	500-3526 ..... 1" ..... 26mm
	500-3530 ..... 1 1/4" ..... 30mm

### Boxed Chisel Sets

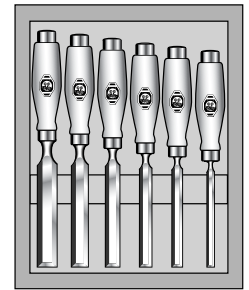

Set of four and a set of six wooden handled bevel edge chisels in a fitted wooden box. Keeps your chisels protected in storage and ready to use. Set of six contains 6-10-12-16-20-26mm chisels. Set of four contains 10-16-20-26mm chisels.

- 500-1559 ..... Set of Four in Wooden Box
- 500-1561 ..... Set of Six in Wooden Box

### Set of Chisels in Leather Tool Roll

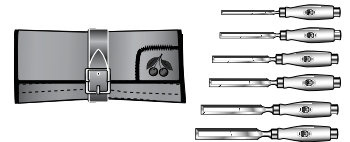

High quality Two Cherries leather tool roll with six bevel edge chisels with wooden handles described on this page. Sizes 6-10-12-16-20-26mm. There are an additional six pockets within the tool roll for future tools. This is an ideal set for any woodworker.

- 500-1575 ..... Two Cherries Chisels in Roll



Since 1858

Two Cherries tools are still largely made in the same way in which they were made decades ago. Where change has been introduced it has only enhanced the quality of the product. The finest steel is used throughout the product line, and skilled craftsmen still work with diligence to bring you a tool that you will be proud to own and love to work with. In fact, your children and grandchildren will be just as pleased to use these tools - tools made with care.





**Mortise Chisels**

A heavy tool in a strong pattern. A truly impressive tool for mortising. This tool has a heavy, round hornbeam handle and a leather disc shock absorber. Overall length about 13" to 14". This is the correct tool for cutting deep and straight mortises in all types of wood.

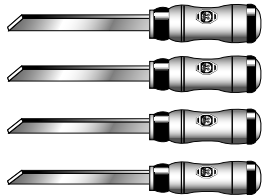

500-2199 ..... Set of Four

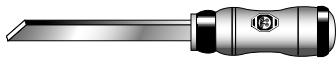

500-2006 ..... 6 mm  
500-2008 ..... 8 mm  
500-2010 ..... 10 mm  
500-2012 ..... 12 mm

**Swan Neck  
Mortise Chisel**



Use in conjunction with the mortise chisels above for cleaning the bottom of a mortise. Similar in construction to the mortise chisel with an overall length is about 12" to 15".

500-2106 ..... 6 mm  
500-2110 ..... 10 mm  
500-2112 ..... 12 mm

**Bevel Edge Chisel  
Curved Blade**



This is a real problem solver tool! While you might not pick it up to use each day, you will find yourself using it more and more, doing work that you could not have easily done before. Skilled craftsmen throughout the world have been amazed at the variety of uses for these tools, and "problems" that this unique tool has solved for them. These three chisels are the same high quality as all Two Cherrys chisels, and are fitted with a wooden handle.

500-1710 ..... 10mm  
500-1716 ..... 16mm  
500-1720 ..... 20mm

**Set of Four Butt Chisels — Wooden Handles**



Ideal for precise bench work these handsome, shorter chisels fit comfortably in the palm of your hand. Chisels are approximately 6 5/8" overall length and the set consists of 6mm, 12mm, 20mm and 26mm (1/4", 1/2", 3/4", 1") sizes. Made of Two Cherrys' high quality steel and hardened to a Rockwell hardness of HRC 61.

500-4575 ..... Set of Four Wood Handled Butt Chisels

**Bevel Edge Chisel Sets  
In Wooden Case**

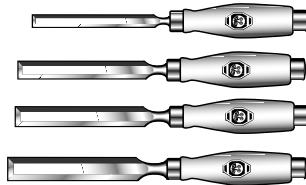

Unpolished sets of Two Cherrys chisels. These tools are nearly identical to the standard production tools shown on the previous page. The only differences are that the blades are not high polished and a slightly different shaped wooden handle is used. Same steel, same forging, same heat treating, same grinding. An economical alternative for the woodworker on a budget. Available in a set of four containing 10, 16, 20, and 26mm chisels, or a set of six which adds a 6mm and 12mm chisel.

500-9050 ..... Four Chisels in Wood Box  
500-9060 ..... Six Chisels in Wood Box

**Skew Chisels**



Two Cherrys bevel edge chisels with a skew cutting edge. This design permits hand controlled paring and other types of detail work. It is very practical for trimming slightly protruding dovetails, tenons, dowels and other applications when finesse, not chopping is required. Available in three sizes and sold as left and right angled forms. Wooden handles.

500-1912 ..... 12mm Skew Chisels (Pair)  
500-1920 ..... 20mm Skew Chisels (Pair)  
500-1926 ..... 26mm Skew Chisels (Pair)

**Straight Edge Chisels**



Straight edge chisels for extra strength. The same highest quality steel and construction found in the Two Cherrys bevel edge chisels, overall length is approximately ten to thirteen inches.

500-1412 ..... 12 mm  
500-1420 ..... 20 mm  
500-1426 ..... 26 mm  
500-1440 ..... 40 mm  
500-1450 ..... 50 mm

**Gouges**

Two styles of fine quality hand forged Gouges. Out-Cannel has cutting edge on the front side. In-Cannel has cutting edge on the back side. Overall lengths of approximately ten to eleven inches.



<b>Out-Cannel</b>	<b>Size</b>
500-1006	6 mm
500-1012	12 mm
500-1020	20 mm
500-1025	26 mm



<b>In-Cannel</b>	<b>Size</b>
500-1106	6 mm
500-1112	12 mm
500-1120	20 mm
500-1126	26 mm

**Curved Gouge**



An extremely useful variation on the firmer gouge. Bevel is on the outside of the blade, and the tool has an overall length of nine to eleven inches. Highest quality German steel.

500-0906 ..... 6 mm  
500-0912 ..... 12 mm  
500-0920 ..... 20 mm  
500-0925 ..... 26 mm

**Problem Solver Kit**



Kit of four tools especially selected to deal with troublesome woodworking issues. Includes: 4 and 26 mm bevel edge chisels, 12mm firmer gouge and 20mm curved chisel. With the Problem Solver Kit you always have the right chisel on hand. Comes in a fitted wooden box.

500-1850 ..... Problem Solver Kit

**90 Degree Mortise Chisel**



A handy, timesaving tool used after drilling or routing a mortise. The tool is an inside bevel 90° chisel used to square the mortise corners.

500-4050 ..... 12 mm Mortise Chisel

**Two Cherrys  
Chisel Edge Guards**



The same chisel edge guards that come with the Two Cherrys bevel edge chisels. Sizes for chisels 6, 10, 12, 16, 20, and 26mm.

500-1590 ..... Set of Six

**Replacement Handles**



Replacement wooden handles available in five sizes. Fit is specified for the bevel edge chisels.

<b>Number</b>	<b>Fits Blades</b>	<b>Length</b>
500-1620	2 mm-10 mm	120 mm
500-1625	12 mm-16 mm	125 mm
500-1630	20 mm-26 mm	130 mm
500-1640	30 mm	140 mm
500-1650	40 mm-50 mm	150 mm



### Bevel Edge Chisel



These bevel edge chisels are made from top quality tool steel. Impact plastic handle with a bevel edge guard designed for a comfortable grip. Comes with a strong plastic edge guard to protect edge. Overall length to twelve inches in overall length. Set of four contains 1/4", 1/2", 3/4", 1" chisels. Set of six contains all chisels 1/4" to 1". Footprint

Cellulose Acetate Handle

615-1160	.....Set/4
615-1170	.....Set/6
615-1065	.....1/8"
615-1070	.....1/4"
615-1080	.....3/8"
615-1090	.....1/2"
615-1100	.....5/8"
615-1110	.....3/4"
615-1120	.....1"
615-1130	.....1 1/4"
615-1140	.....1 1/2"

### Chisel Edge Guards

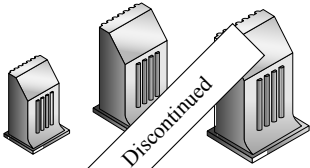

Plastic chisel edge guards. Invaluable aid to protect chisel edges. Fits Footprint and other English made chisels.  
615-1299..... Set of 6

### ENGLISH CHISELS

#### Paring Chisel

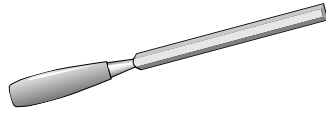

Long slim blades, carefully ground flat on the backs. Nicely shaped beechwood handles add to the pleasure of using them. Twelve to fourteen inches in overall length.

680-4004	.....1/4"
680-4008	.....1/2"
680-4012	.....3/4"
680-4016	.....1"
680-4020	.....1 1/4"

#### Cranked Paring Chisel



Shaped for hand working on flat surfaces, the cranked paring chisel, with it's offset handle, is designed for cleaning up dados, rabbets, the insides of cabinets and drawers and the centers of large flat areas, such as, table tops. Available in four popular widths.

680-5504	.....1/4"
680-5508	.....1/2"
680-5512	.....3/4"
680-5516	.....1"

#### Registered Mortise Chisel

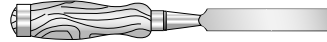

For mortise and general heavy duty work, this is one of the finest chisels made in the world today--made like chisels were made years ago. Overall length about ten to fourteen inches. Size shown is nominal, and actual size will be up to 1/32" undersize.

680-4504	.....1/4"
680-4506	.....3/8"
680-4508	.....1/2"
680-4512	.....3/4"
680-4516	.....1"
680-4520	.....1 1/4"
680-4524	.....1 1/2"
680-4532	.....2"

#### Timber Framing Chisel



Heavy duty beveled and non-beveled timber framing chisels by Robert Sorby. Originally designed for North American log cabin building. Overall length about eighteen to twenty inches.

Beveled Chisel	Size	Handle Only
640-2016	.....1"	.....640-4102
640-2024	.....1 1/2"	.....640-4103
640-2032	.....2"	.....640-4103

Non-Beveled Chisel	Size
640-2116	.....1"
640-2124	.....1 1/2"
640-2132	.....2"
640-4110	.....Replacement Handle Only

### Leather Apron

This quality leather apron is made for woodworkers. The velour leather not only provides good body protection, but it



is also a long wearing apron. Made from durable materials, it has a fully adjustable nylon waist and adjustable neck straps, both with a quick-release buckle. Stress points are reinforced with rivets. The three bottom pockets and the top pocket are able to keep a variety of tools. The backside of the apron is covered with a black lining. The Two Cherries logo is embroidered on the front.

524-7100..... Two Cherries Leather Apron

### Leather Tool Roll



Made of the same high quality velour leather as the Leather Apron. The supple leather is soft and manageable and provides ideal protection for chisels and carving tools. It has 12 pockets and, when closed, it is secured by a belt-like strap. The Two Cherries logo is embroidered on the front.

524-7200..... Two Cherries Tool Roll

### Whittler's Apron

This very heavy duty denim apron has two permanent pockets and a very large pouch held with velcro so that you can empty out those shavings that inevitably collect. The pouch can also be kept open, giving the woodworker an extra long apron.

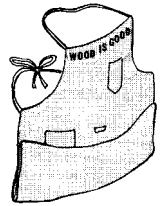

170-2300..... Whittler's Apron

### Wood is Good Tool Cases

These Wood is Good tool rolls and pouches are the perfect answer to tool storage needs! Choose from a simple six pocket or twelve pocket roll, or the twenty-four pocket vinyl or denim zip-up cases, or the twelve pocket roll made specifically for smaller tools.

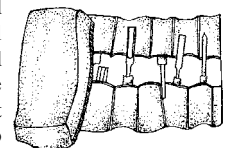

170-2006..... Tool Roll - 6 pocket  
170-2012..... Tool Roll - 12 pocket  
170-1912..... Small Tool Roll - 12 pocket  
170-2100..... Roll with Vinyl Case  
170-2200..... Roll with Denim Case

### JAPANESE CHISELS & TOOL ROLL

#### Oire Nomi Chisel Set



These are our finest chisels which are offered as a set only. They are produced using laminated steel construction for an edge that can hold an incredible sharpness (hard steel) and yet is backed up with a softer steel, giving tremendous strength. Set of five chisels includes 6-9-12-18-24 mm sizes. All chisels are between eight and nine inches in overall length.

710-1085..... Set/5

#### Oire Nomi Chisels



These chisels are produced using laminated steel construction for an edge that can hold an incredible sharpness (hard steel) and yet is backed up with a softer steel, giving tremendous strength. All chisels are between eight and nine inches in overall length.

710-1003	.....3 mm
710-1006	.....6 mm
710-1009	.....9 mm
710-1012	.....12 mm
710-1018	.....18 mm
710-1024	.....24 mm
710-1030	.....30 mm
710-1042	.....42 mm

#### Leather Chisel Roll

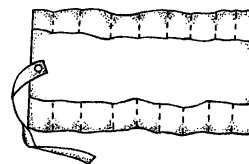

These leather chisel rolls are especially designed for Japanese chisels. Larger size is for longer chisels and measures twelve inches wide by eighteen inches long. Chisels can be up to about eleven inches in length. The smaller chisel roll measures nine inches by fifteen inches and will accommodate chisels up to about eight inches in length. Both rolls have pockets to accommodate ten chisels and a single leather strap to keep the roll closed.

780-1050	.....Large Size Chisel Roll
780-2000	.....Small Size Chisel Roll



TOOL STORAGE

Leather Turning Tool Roll

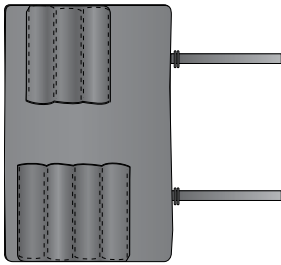

This beautiful and useful leather tool roll will accept most turning tools with ten inch handles, and some larger tools as well. Cotton straps are used to keep the roll closed, and have sliding metal buckles. Handles of tools are inserted in the pockets, so that you can easily spot the tool you are looking for. Maximum tool length about 23".

845-1550 .....Seven Pockets

Leather tool roll for small turning tools. This roll will accept five tools, such as those in our miniature turning tool set number 920-0300. Different design than the roll above, similar in style to the nylon turning roll below. Accepts tools to about 11" in length.

845-1540 ..... Five Pockets

Nylon Turning Tool Roll

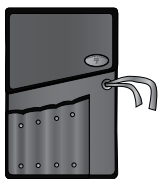

Heavy duty nylon material with riveted pockets. This roll is perfect for your turning tools, to protect them when they are not being used. The five tool roll closes with a simple tie, while the eight tool roll is fitted with a quick release plastic clip. Will fit tools up to just under 20" in length.

845-1560 ..... Fits Five

845-1570 ..... Fits Eight

Leather Plane Blade Wallet



Leather plane case folds up just like a wallet. Fits eight irons, with each iron being protected by heavy duty nylon separators. Two brass snaps are used to close the wallet. Accepts virtually any plane iron for any plane.

845-1200 ..... Fits Eight

Proper storage of fine tools, especially cutting tools, is a must. To reduce unnecessary damage, the use of tool rolls and tool holders is recommended. Quality man-made materials and leather both provide unsurpassed storage. When choosing tool rolls and tool holders, note the use of durable materials, rugged dividers and gussets and the type of closures best suited to your needs. A tool drawer with multiple tool rolls makes for a perfect picture.

The leather products found on this page are produced from leather that is ideal for tools. The tanning process is done without heavy metals and human-harmful chemicals so that the products are both safe for the craftsman and minimize tool oxidation. Made in France.

Leather Apron

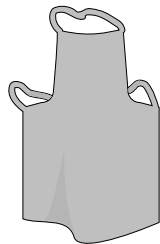

Long wearing leather apron is 34" in overall length. Provides a good amount of protection as well as keeping your clothes clean.

845-1300 ..... Leather Apron

Leather Carving Tool Rolls

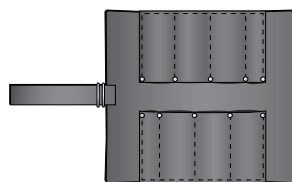

Made of soft leather with pockets at top and bottom. Pockets are designed to accept the tool handle and are slightly offset from the pocket on the other side of the roll. This allows you to see at a glance the tool that you are looking for. Closes with a cotton strap and metal sliding buckle. Accepts tools up to about 12" in length.

845-1410 ..... Fits Six Tools

845-1420 ..... Fits Twelve Tools



Tool roll for Two Cherries miniature carving tools. Fits all five styles.

845-1520 ..... Tool Roll Only

Nylon Carving Tool Rolls

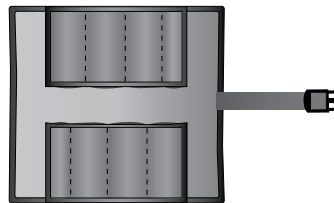

Strong nylon material makes these two rolls the perfect thing in which to protect your carving tools. Each has a row of pockets opposite each other, and typically the handles go into the pockets and the blades are exposed for ease of recognition. Nylon closing strap with plastic quick klik attachment. Accepts tools up to about 12" in length.

845-1506 ..... Fits Six Carving Tools

845-1512 ..... Fits Twelve Carving Tools

Chisel Rolls

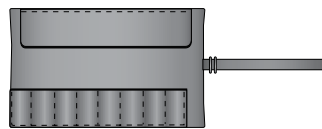

Soft leather chisel rolls with large pockets on one side and protective flap on the other. Solid brass rivets at the top of each pocket add strength to the construction. Closed with a cotton strap and metal sliding buckle. Accepts tools up to about 12" in length.

845-2150 ..... Fits 8

845-2175 ..... Fits 12

Similar construction to the leather chisel rolls above, this tool roll is made of heavy duty nylon. Very strong and extremely functional chisel roll. Accepts tools up to about 12" in length.

845-2190 ..... Nylon Chisel Roll

Japanese Saw Cases



Japanese saw case made of soft leather with three inside leather separations that make four saw compartments. Uses solid brass rivets on bottom and far side, which will not harm saw teeth. Back extension is also a closing flap for saw case. Cotton strap with metal sliding buckle. Note that this case can be used for many western style saws as well.

845-1250 ..... Fits Four Saws



Heavy duty nylon construction in a case designed for three Japanese style saws. Can be used for many Western saws as well. Uses a simple tie closing.

845-1275 ..... Three Saw

Leather Scraper Holder



Made of soft leather, this wallet type holder is designed to hold your cabinet scrapers and protect them when they are not in use.

Inside are extra heavy nylon separators so that the pouch can hold four scrapers -- flat and curved. On the back is a belt attachment so that you can always have your scrapers handy to use. Fits virtually any cabinet scraper made.

845-1050 ..... Scraper Holder

Block Plane Holster



Keep the block plane close at hand and free from tool box wear and tear. Whether using a ladder or out on the job site, this belt holster will keep the ever-needed block plane within arms reach. Constructed of tough cordura with a strong and beautiful leather front. Fits most block planes available today.

845-1150 ..... Block Plane Holster





# Robert Larson Company

## KELLER DOVETAIL SYSTEM

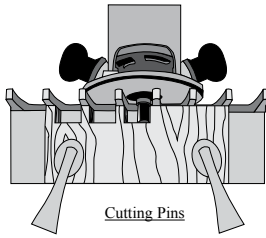

Cutting Pins

### The KELLER DOVETAIL SYSTEM

Lets You Spend More Time Working  
With Wood, Less Time Adjusting Tools

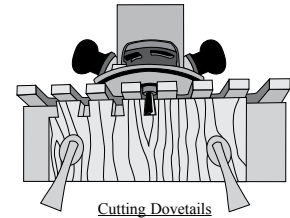

Cutting Dovetails

Because it is engineered for people who are not engineers, the Keller Dovetail System requires only your common sense and a router to get started. You simply clamp the Keller Dovetail Templates to your workpiece, pick up your router, and start cutting. In only 2 to 5 minutes you will cut both halves of a dovetail joint. The results will be clean, precise, and snug fitting, with beautiful hand-cut proportions

Lets You Cut Any Width Stock, and Vary Wood Thicknesses Easily...

All models give you through-dovetail joints in any width stock. Unlike other jigs, there are no built-in stops to limit the width of your work. If your work is wider than your templates, simply slide the templates along and continue cutting. Keller gives you a consistently tight dovetail joint regardless of the wood thickness or the router bit setting. All other jigs require time-wasting readjustments and test cuts every time you change your wood thickness. In addition, you can join wood of the same or different thicknesses with the same setup.

For Production Runs or Unique Heirlooms...

Classic or avant-garde project, Keller gives you strength, beauty, and speed. Each of the models has preset spacing especially designed in the classic proportions of handcut dovetails. Keller gives you these distinctive dovetail joints of traditional styling.

All Models Include . . .

Two precision templates (one only for The Journeyman models). Two carbide-tipped router bits (standard dimensions), one dovetail and one straight cutter. Two ball-bearing template guides, mounted on each router bit shank. Fully illustrated instruction manual for mounting and use. Each template requires a simple wooden backing block, not included. You can vary the spacing by merely shifting the location of the templates in between cuts, changing the size of the tails or pins, while easily maintaining excellent accuracy and beautiful proportions.

### Journeyman Models

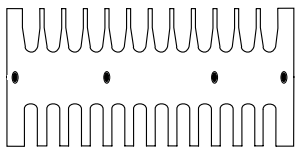

Journeyman Model 135-1500

This model is designed for joining smaller projects such as cabinets, drawers, jewelry boxes, and gift items. The double sided template comes with two router bits each with shank mounted bearings, and instructions.

Wood Width Capacity:.....Unlimited  
Length of Templates:..... 15"  
Wood Thickness Capacity:..... $\frac{1}{8}$ "- $\frac{3}{4}$ "  
-with Rabbeted Pins:.....Up to 1"  
Dovetail Angle:..... 7 degree (8:1)  
Pin Spacing, center to center:..... $\frac{1}{8}$ "  
Minimum Router hp Required:..... $\frac{3}{4}$ hp  
Router Collet Size Required:..... $\frac{1}{4}$ "  
Shipping Weight:..... 2 lbs

### Journeyman Model 135-2200

The larger 2200 model cuts dovetails for larger furniture, cabinets, casegoods, fixtures, and chests. The double sided template comes with two router bits each with shank mounted bearings, and instructions.

Wood Width Capacity:.....Unlimited  
Length of Templates:..... 22"  
Wood Thickness Capacity:..... $\frac{1}{4}$ "-1"  
-with Rabbeted Pins:.....Up to  $\frac{1}{2}$ "  
Dovetail Angle:..... 7 degree (8:1)  
Pin Spacing, center to center:..... $\frac{1}{4}$ "  
Minimum Router hp Required:..... $\frac{1}{4}$ hp  
Router Collet Size Required:..... $\frac{1}{2}$ " or  $\frac{3}{8}$ "  
Shipping Weight:..... 3 lbs

### Professional Models

The templates of all three professional versions of the Keller Dovetail System are made of aluminum and designed to be real workhorses in the professional shop and factory.

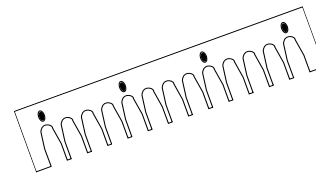
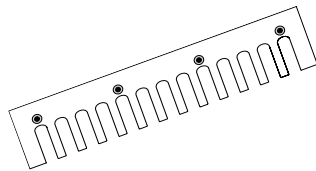

### Professional Model 135-2401

Very popular midsize Keller Dovetail System model that was designed especially for furniture, cabinets, and casegoods. Comes with two aluminum templates, two router bits each with shank mounted bearings, and an instruction booklet.

Wood Width Capacity:.....Unlimited  
Length of Templates:..... 24"  
Wood Thickness Capacity:..... $\frac{1}{4}$ "-1"  
-with Rabbeted Pins:.....Up to  $\frac{1}{2}$ "  
Dovetail Angle:..... 7 degree (8:1)  
Pin Spacing, center to center:..... $\frac{1}{4}$ "  
Minimum Router hp Required:..... $\frac{1}{4}$ hp  
Router Collet Size Required:..... $\frac{1}{2}$ " or  $\frac{3}{8}$ "  
Shipping Weight:..... 8 lbs

### Professional Model 135-1601

This model is designed for joining smaller projects, such as cabinets, drawers, jewelry boxes, and gift items. Comes with two aluminum templates, two router bits each with shank mounted bearings, and an instruction booklet.

Wood Width Capacity:.....Unlimited  
Length of Templates:..... 16"  
Wood Thickness Capacity:..... $\frac{1}{8}$ "- $\frac{3}{4}$ "  
-with Rabbeted Pins:.....Up to 1"  
Dovetail Angle:..... 7 degree (8:1)  
Pin Spacing, center to center:..... $\frac{1}{8}$ "  
Minimum Router hp Required:..... $\frac{3}{4}$ hp  
Router Collet Size Required:..... $\frac{1}{4}$ "  
Shipping Weight:..... 5 lbs

### Model 135-3600

Industrial workhorse scaled for larger furniture, cabinets, casegoods, fixtures & chests. Improved version of the original Keller Dovetail Template. Comes with two aluminum templates, two router bits each with shank mounted bearings, and an instruction booklet.

Wood Width Capacity:.....Unlimited  
Length of Templates:..... 36"  
Wood Thickness Capacity:..... $\frac{1}{2}$ "-  $\frac{1}{4}$ "  
-with Rabbeted Pins:.....Up to  $\frac{1}{2}$ "  
Dovetail Angle:..... 14 degree (4:1)  
Pin Spacing, center to center:..... 3"  
Minimum Router hp Required:..... $\frac{1}{2}$ hp  
Router Collet Size Required:..... $\frac{1}{2}$ "  
Shipping Weight:..... 13 lbs

### Bits & Bearings for the 1500 & 2401 (with diameter and carbide height)

Standard Dovetail ( $\frac{7}{16}$ " x  $\frac{3}{4}$ " )..... 135-1633  
Standard Straight ( $\frac{5}{8}$ " x  $\frac{3}{4}$ " )..... 135-1643  
Standard Set ..... 135-1695  
Optional Dovetail ( $\frac{1}{2}$ " x  $\frac{3}{8}$ " )..... 135-1631  
Optional Straight ( $\frac{5}{8}$ " x  $\frac{1}{2}$ " )..... 135-1641  
Optional Set ..... 135-1690  
Box Joint Bit ..... 135-1642  
Bearing for all bits above..... 135-7225

### Bits & Bearings for the 2200 & 2401 (with diameter and carbide height)

Standard Dovetail ( $\frac{9}{16}$ " x 1" )..... 135-2435  
Standard Straight ( $\frac{7}{8}$ " x 1" )..... 135-2445  
Standard Set ..... 135-2495  
Optional Dovetail ( $\frac{1}{2}$ " x  $\frac{3}{4}$ " )..... 135-2433  
Optional Straight ( $\frac{5}{8}$ " x  $\frac{3}{4}$ " )..... 135-2443  
Optional Set ..... 135-2490  
Box Joint Bit ..... Use 135-2445  
Bearing for 135-2433 ..... 135-7227  
Bearing for 135-2443 ..... 135-7225  
Bearing for all other bits ..... 135-7237  
Collet Adapter  $\frac{3}{8}$ " -  $\frac{1}{2}$ " ..... 135-2425

### Bits & Bearings for the 3600 (with diameter and carbide height)

Standard Dovetail (1" x 1" )..... 135-3637  
Standard Straight ( $\frac{7}{8}$ " x 1" )..... 135-3645  
Standard Set ..... 135-3690  
Optional Dovetail (1 $\frac{1}{8}$ " x 1 $\frac{1}{4}$ " )..... 135-3639  
Optional Straight ( $\frac{7}{8}$ " x 1 $\frac{1}{4}$ " )..... 135-3649  
Optional Set ..... 135-3695  
Box Joint Bit ..... Use 135-3645  
Bearing for 135-3637 & 3639 ..... 135-7249  
Bearing for 135-3645 & 3649 ..... 135-7237

### Dovetail System Video & Instruction Book

The Keller Dovetail System Video and Instruction Book show step-by-step demonstrations of the system's basic operation, plus an overview of its other capabilities.

135-8000 ..... VHS  
135-8500 ..... DVD  
135-0026 ..... Instruction Book



TWO CHERRIES CARVING TOOLS

Traditional Full Size Tools

In production for over one hundred and fifty years, are available in nearly 750 different sizes and shapes. There are no carving chisels made anywhere in the world today that surpass the quality of these German tools. These are professional, long model tools, fine polished inside and outside, with a blade length (without tang) of 125mm.

Sharpened Edges

Two Cherries carving tools now come sharpened for use, directly from the factory. Simply take the tool out of the package and get to work! (*Sharpened edges will be phased into all full size carving tools throughout 2009*)

Numbering

Ordering carving tools can be confusing, so here is an explanation of the numbering system for our full size professional tools. All our tools have a seven digit number (XXX-XXXX). The first three digits for all professional carving tools is 505 (505-XXXX). The next two digits indicate the "sweep" of the tool (505-08XX). The last two digits indicate the width of the cutting edge (505-0812). The preceding example (505-0812) indicates a professional Two Cherries #8-sweep straight gouge with a cutting edge of 12mm. Note that the sweep illustrations are not shown to size.

Handles

All tools come standard with a fine quality octagon handle. In addition, all tools of 25mm or larger have double-hooped handles for added strength.



Sweep #1

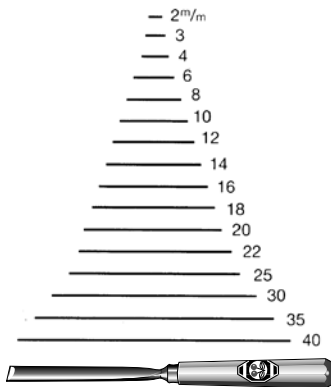

- 505-0102 ..... Straight Chisel ..... 02mm
- 505-0103 ..... Straight Chisel ..... 03mm
- 505-0104 ..... Straight Chisel ..... 04mm
- 505-0106 ..... Straight Chisel ..... 06mm
- 505-0108 ..... Straight Chisel ..... 08mm
- 505-0110 ..... Straight Chisel ..... 10mm
- 505-0112 ..... Straight Chisel ..... 12mm
- 505-0114 ..... Straight Chisel ..... 14mm
- 505-0116 ..... Straight Chisel ..... 16mm
- 505-0118 ..... Straight Chisel ..... 18mm
- 505-0120 ..... Straight Chisel ..... 20mm
- 505-0125 ..... Straight Chisel ..... 25mm
- 505-0130 ..... Straight Chisel ..... 30mm
- 505-0135 ..... Straight Chisel ..... 35mm



- 505-0202 ..... Skew Chisel ..... 02mm
- 505-0203 ..... Skew Chisel ..... 03mm
- 505-0204 ..... Skew Chisel ..... 04mm
- 505-0206 ..... Skew Chisel ..... 06mm
- 505-0208 ..... Skew Chisel ..... 08mm
- 505-0210 ..... Skew Chisel ..... 10mm
- 505-0212 ..... Skew Chisel ..... 12mm
- 505-0214 ..... Skew Chisel ..... 14mm
- 505-0216 ..... Skew Chisel ..... 16mm
- 505-0218 ..... Skew Chisel ..... 18mm
- 505-0220 ..... Skew Chisel ..... 20mm
- 505-0225 ..... Skew Chisel ..... 25mm
- 505-0230 ..... Skew Chisel ..... 30mm
- 505-0235 ..... Skew Chisel ..... 35mm



- 505-2103 ..... Spoon Bent ..... 03mm
- 505-2106 ..... Spoon Bent ..... 06mm
- 505-2112 ..... Spoon Bent ..... 12mm
- 505-2116 ..... Spoon Bent ..... 16mm
- 505-2118 ..... Spoon Bent ..... 18mm



- 505-7102 ..... Spade Chisel ..... 02mm
- 505-7106 ..... Spade Chisel ..... 06mm
- 505-7110 ..... Spade Chisel ..... 10mm
- 505-7116 ..... Spade Chisel ..... 16mm
- 505-7112 ..... Spade Gouge ..... 12mm

Sweep #3

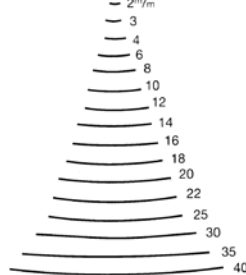

- 505-0302 ..... Straight Gouge ..... 02mm
- 505-0303 ..... Straight Gouge ..... 03mm
- 505-0304 ..... Straight Gouge ..... 04mm
- 505-0306 ..... Straight Gouge ..... 06mm
- 505-0308 ..... Straight Gouge ..... 08mm
- 505-0310 ..... Straight Gouge ..... 10mm
- 505-0312 ..... Straight Gouge ..... 12mm
- 505-0314 ..... Straight Gouge ..... 14mm
- 505-0316 ..... Straight Gouge ..... 16mm
- 505-0318 ..... Straight Gouge ..... 18mm
- 505-0320 ..... Straight Gouge ..... 20mm
- 505-0325 ..... Straight Gouge ..... 25mm
- 505-0330 ..... Straight Gouge ..... 30mm
- 505-0335 ..... Straight Gouge ..... 35mm



- 505-2404 ..... Spoon Bent ..... 04mm
- 505-2406 ..... Spoon Bent ..... 06mm
- 505-2412 ..... Spoon Bent ..... 12mm
- 505-2416 ..... Spoon Bent ..... 16mm
- 505-2418 ..... Spoon Bent ..... 18mm
- 505-2425 ..... Spoon Bent ..... 25mm



- 505-3310 ..... Back Bent ..... 10mm
- 505-3314 ..... Back Bent ..... 14mm



- 505-7304 ..... Spade Gouge ..... 04mm
- 505-7308 ..... Spade Gouge ..... 08mm
- 505-7316 ..... Spade Gouge ..... 16mm

Sweep #4

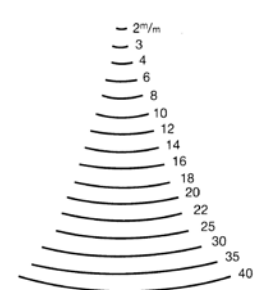

- 505-0402 ..... Straight Gouge ..... 02mm
- 505-0403 ..... Straight Gouge ..... 03mm
- 505-0404 ..... Straight Gouge ..... 04mm
- 505-0406 ..... Straight Gouge ..... 06mm
- 505-0408 ..... Straight Gouge ..... 08mm
- 505-0410 ..... Straight Gouge ..... 10mm
- 505-0412 ..... Straight Gouge ..... 12mm
- 505-0414 ..... Straight Gouge ..... 14mm
- 505-0416 ..... Straight Gouge ..... 16mm
- 505-0418 ..... Straight Gouge ..... 18mm
- 505-0420 ..... Straight Gouge ..... 20mm
- 505-0425 ..... Straight Gouge ..... 25mm
- 505-0430 ..... Straight Gouge ..... 30mm
- 505-0435 ..... Straight Gouge ..... 35mm



- 505-1306 ..... Long Bent ..... 06mm
- 505-1310 ..... Long Bent ..... 10mm
- 505-1312 ..... Long Bent ..... 12mm
- 505-1314 ..... Long Bent ..... 14mm
- 505-1316 ..... Long Bent ..... 16mm
- 505-1320 ..... Long Bent ..... 20mm
- 505-1322 ..... Long Bent ..... 22mm
- 505-1325 ..... Long Bent ..... 25mm



- 505-2504 ..... Spoon Bent ..... 04mm
- 505-2506 ..... Spoon Bent ..... 06mm
- 505-2512 ..... Spoon Bent ..... 12mm
- 505-2516 ..... Spoon Bent ..... 16mm
- 505-2518 ..... Spoon Bent ..... 18mm
- 505-2525 ..... Spoon Bent ..... 25mm

Two Cherries Sharpening DVD



An instructional DVD from Two Cherries covering the sharpening of chisel and plane blades, as well as a wide range of carving tool sweeps and sizes, from 1mm micro gouges to 3" fishtail tools, V-tools, and more. The sharpening methods demonstrated use only easy to find sharpening equipment and shop-made jigs. The techniques do not require the use of hard to find or expensive equipment. The instructor also shows how to repair and restore a damaged cutting edge. DVD can be played in English, Spanish, German, Dutch, or French. Approximately 73 minutes.  
524-7500..... Sharpening Video



TWO CHERRIES CARVING TOOLS

Sweep #5

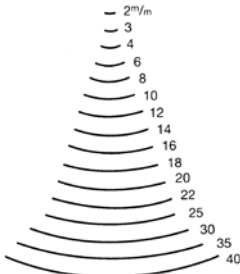

- 505-0502 ..... Straight Gouge ..... 02mm
- 505-0503 ..... Straight Gouge ..... 03mm
- 505-0504 ..... Straight Gouge ..... 04mm
- 505-0506 ..... Straight Gouge ..... 06mm
- 505-0508 ..... Straight Gouge ..... 08mm
- 505-0510 ..... Straight Gouge ..... 10mm
- 505-0512 ..... Straight Gouge ..... 12mm
- 505-0514 ..... Straight Gouge ..... 14mm
- 505-0516 ..... Straight Gouge ..... 16mm
- 505-0518 ..... Straight Gouge ..... 18mm
- 505-0520 ..... Straight Gouge ..... 20mm
- 505-0522 ..... Straight Gouge ..... 22mm
- 505-0525 ..... Straight Gouge ..... 25mm
- 505-0530 ..... Straight Gouge ..... 30mm
- 505-0535 ..... Straight Gouge ..... 35mm



- 505-1406 ..... Curved Gouge ..... 06mm
- 505-1410 ..... Curved Gouge ..... 10mm
- 505-1412 ..... Curved Gouge ..... 12mm
- 505-1414 ..... Curved Gouge ..... 14mm
- 505-1416 ..... Curved Gouge ..... 16mm
- 505-1420 ..... Curved Gouge ..... 20mm
- 505-1422 ..... Curved Gouge ..... 22mm
- 505-1425 ..... Curved Gouge ..... 25mm



- 505-2604 ..... Spoon Bent Gouge ..... 04mm
- 505-2606 ..... Spoon Bent Gouge ..... 06mm
- 505-2610 ..... Spoon Bent Gouge ..... 10mm
- 505-2612 ..... Spoon Bent Gouge ..... 12mm
- 505-2616 ..... Spoon Bent Gouge ..... 16mm
- 505-2618 ..... Spoon Bent Gouge ..... 18mm



- 505-7516 ..... Spade Gouge ..... 16mm

Sweep #6

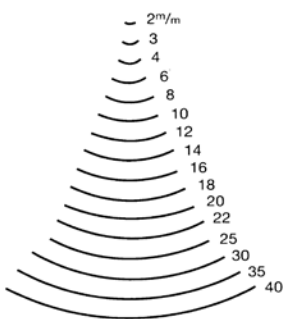

- 505-0602 ..... Straight Gouge ..... 02mm
- 505-0603 ..... Straight Gouge ..... 03mm
- 505-0604 ..... Straight Gouge ..... 04mm
- 505-0606 ..... Straight Gouge ..... 06mm
- 505-0608 ..... Straight Gouge ..... 08mm
- 505-0610 ..... Straight Gouge ..... 10mm
- 505-0612 ..... Straight Gouge ..... 12mm
- 505-0614 ..... Straight Gouge ..... 14mm

- 505-0616 ..... Straight Gouge ..... 16mm
- 505-0618 ..... Straight Gouge ..... 18mm
- 505-0620 ..... Straight Gouge ..... 20mm
- 505-0625 ..... Straight Gouge ..... 25mm
- 505-0630 ..... Straight Gouge ..... 30mm
- 505-0635 ..... Straight Gouge ..... 35mm



- 505-1506 ..... Curved Gouge ..... 06mm
- 505-1510 ..... Curved Gouge ..... 10mm
- 505-1512 ..... Curved Gouge ..... 12mm
- 505-1514 ..... Curved Gouge ..... 14mm
- 505-1516 ..... Curved Gouge ..... 16mm
- 505-1520 ..... Curved Gouge ..... 20mm
- 505-1525 ..... Curved Gouge ..... 25mm
- 505-1535 ..... Curved Gouge ..... 35mm



- 505-2704 ..... Spoon Bent Gouge ..... 04mm
- 505-2706 ..... Spoon Bent Gouge ..... 06mm
- 505-2712 ..... Spoon Bent Gouge ..... 12mm
- 505-2716 ..... Spoon Bent Gouge ..... 16mm
- 505-2718 ..... Spoon Bent Gouge ..... 18mm



- 505-3606 ..... Back Bent Gouge ..... 06mm
- 505-3610 ..... Back Bent Gouge ..... 10mm



- 505-7602 ..... Spade Gouge ..... 02mm
- 505-7606 ..... Spade Gouge ..... 06mm
- 505-7610 ..... Spade Gouge ..... 10mm
- 505-7616 ..... Spade Gouge ..... 16mm

Sweep #7

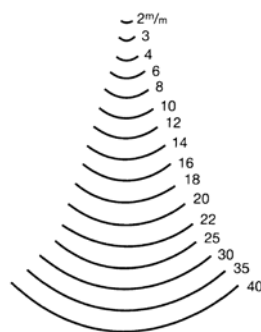

- 505-0702 ..... Straight Chisel ..... 02mm
- 505-0703 ..... Straight Chisel ..... 03mm
- 505-0704 ..... Straight Chisel ..... 04mm
- 505-0706 ..... Straight Chisel ..... 06mm
- 505-0708 ..... Straight Chisel ..... 08mm
- 505-0710 ..... Straight Chisel ..... 10mm
- 505-0712 ..... Straight Chisel ..... 12mm
- 505-0714 ..... Straight Chisel ..... 14mm
- 505-0716 ..... Straight Chisel ..... 16mm
- 505-0718 ..... Straight Chisel ..... 18mm
- 505-0720 ..... Straight Chisel ..... 20mm
- 505-0725 ..... Straight Chisel ..... 25mm
- 505-0730 ..... Straight Chisel ..... 30mm
- 505-0735 ..... Straight Chisel ..... 35mm



- 505-1606 ..... Curved Gouge ..... 06mm
- 505-1610 ..... Curved Gouge ..... 10mm

- 505-1612 ..... Curved Gouge ..... 12mm
- 505-1614 ..... Curved Gouge ..... 14mm
- 505-1616 ..... Curved Gouge ..... 16mm
- 505-1620 ..... Curved Gouge ..... 20mm
- 505-1625 ..... Curved Gouge ..... 25mm



- 505-2804 ..... Spoon Bent Gouge ..... 04mm
- 505-2806 ..... Spoon Bent Gouge ..... 06mm
- 505-2808 ..... Spoon Bent Gouge ..... 08mm
- 505-2810 ..... Spoon Bent Gouge ..... 10mm
- 505-2812 ..... Spoon Bent Gouge ..... 12mm
- 505-2816 ..... Spoon Bent Gouge ..... 16mm
- 505-2818 ..... Spoon Bent Gouge ..... 18mm



- 505-7702 ..... Spade Gouge ..... 02mm
- 505-7706 ..... Spade Gouge ..... 06mm
- 505-7710 ..... Spade Gouge ..... 10mm
- 505-7716 ..... Spade Gouge ..... 16mm

Sweep #8

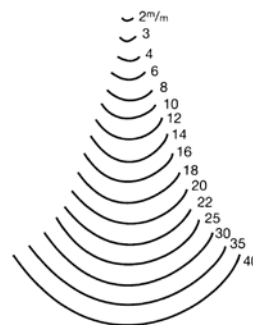

- 505-0802 ..... Straight Gouge ..... 02mm
- 505-0803 ..... Straight Gouge ..... 03mm
- 505-0804 ..... Straight Gouge ..... 04mm
- 505-0806 ..... Straight Gouge ..... 06mm
- 505-0808 ..... Straight Gouge ..... 08mm
- 505-0810 ..... Straight Gouge ..... 10mm
- 505-0812 ..... Straight Gouge ..... 12mm
- 505-0814 ..... Straight Gouge ..... 14mm
- 505-0816 ..... Straight Gouge ..... 16mm
- 505-0818 ..... Straight Gouge ..... 18mm
- 505-0820 ..... Straight Gouge ..... 20mm
- 505-0825 ..... Straight Gouge ..... 25mm
- 505-0830 ..... Straight Gouge ..... 30mm
- 505-0835 ..... Straight Gouge ..... 35mm



- 505-1706 ..... Curved Gouge ..... 06mm
- 505-1710 ..... Curved Gouge ..... 10mm
- 505-1712 ..... Curved Gouge ..... 12mm
- 505-1714 ..... Curved Gouge ..... 14mm
- 505-1716 ..... Curved Gouge ..... 16mm
- 505-1720 ..... Curved Gouge ..... 20mm
- 505-1725 ..... Curved Gouge ..... 25mm



- 505-2904 ..... Spoon Bent Gouge ..... 04mm
- 505-2906 ..... Spoon Bent Gouge ..... 06mm
- 505-2908 ..... Spoon Bent Gouge ..... 08mm
- 505-2910 ..... Spoon Bent Gouge ..... 10mm
- 505-2912 ..... Spoon Bent Gouge ..... 12mm
- 505-2918 ..... Spoon Bent Gouge ..... 18mm
- 505-2935 ..... Spoon Bent Gouge ..... 35mm

Sweep #9

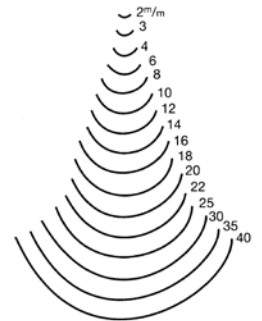

- 505-0902 ..... Straight Gouge ..... 02mm
- 505-0903 ..... Straight Gouge ..... 03mm
- 505-0904 ..... Straight Gouge ..... 04mm
- 505-0906 ..... Straight Gouge ..... 06mm
- 505-0908 ..... Straight Gouge ..... 08mm
- 505-0910 ..... Straight Gouge ..... 10mm
- 505-0912 ..... Straight Gouge ..... 12mm
- 505-0914 ..... Straight Gouge ..... 14mm
- 505-0916 ..... Straight Gouge ..... 16mm
- 505-0918 ..... Straight Gouge ..... 18mm
- 505-0920 ..... Straight Gouge ..... 20mm
- 505-0925 ..... Straight Gouge ..... 25mm
- 505-0930 ..... Straight Gouge ..... 30mm
- 505-0935 ..... Straight Gouge ..... 35mm



- 505-1806 ..... Curved Gouge ..... 06mm
- 505-1808 ..... Curved Gouge ..... 08mm
- 505-1810 ..... Curved Gouge ..... 10mm
- 505-1812 ..... Curved Gouge ..... 12mm
- 505-1814 ..... Curved Gouge ..... 14mm
- 505-1816 ..... Curved Gouge ..... 16mm
- 505-1820 ..... Curved Gouge ..... 20mm
- 505-1825 ..... Curved Gouge ..... 25mm



- 505-3004 ..... Spoon Bent Gouge ..... 04mm
- 505-3006 ..... Spoon Bent Gouge ..... 06mm
- 505-3008 ..... Spoon Bent Gouge ..... 08mm
- 505-3010 ..... Spoon Bent Gouge ..... 10mm
- 505-3012 ..... Spoon Bent Gouge ..... 12mm
- 505-3022 ..... Spoon Bent Gouge ..... 22mm

Sweep #10

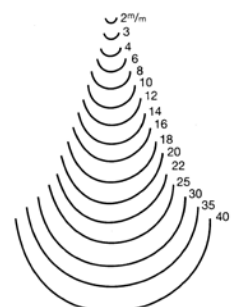

- 505-1002 ..... Straight Gouge ..... 02mm
- 505-1003 ..... Straight Gouge ..... 03mm
- 505-1004 ..... Straight Gouge ..... 04mm
- 505-1006 ..... Straight Gouge ..... 06mm
- 505-1008 ..... Straight Gouge ..... 08mm
- 505-1010 ..... Straight Gouge ..... 10mm
- 505-1012 ..... Straight Gouge ..... 12mm





TWO CHERRIES CARVING TOOLS

- 505-1014 .....Straight Gouge ..... 14mm
- 505-1016 .....Straight Gouge ..... 16mm
- 505-1018 .....Straight Gouge ..... 18mm
- 505-1020 .....Straight Gouge ..... 20mm
- 505-1025 .....Straight Gouge ..... 25mm
- 505-1030 .....Straight Gouge ..... 30mm
- 505-1035 .....Straight Gouge ..... 35mm



- 505-1906 ..... Curved Gouge..... 06mm
- 505-1910 ..... Curved Gouge..... 10mm
- 505-1912 ..... Curved Gouge..... 12mm
- 505-1914 ..... Curved Gouge..... 14mm
- 505-1916 ..... Curved Gouge..... 16mm
- 505-1920 ..... Curved Gouge..... 20mm
- 505-1922 ..... Curved Gouge..... 22mm



- 505-3104 ..... Spoon Bent Gouge .... 04mm
- 505-3106 ..... Spoon Bent Gouge .... 06mm
- 505-3108 ..... Spoon Bent Gouge .... 08mm
- 505-3110 ..... Spoon Bent Gouge .... 10mm
- 505-3112 ..... Spoon Bent Gouge .... 12mm
- 505-3116 ..... Spoon Bent Gouge .... 16mm
- 505-3118 ..... Spoon Bent Gouge .... 18mm

Sweep #11

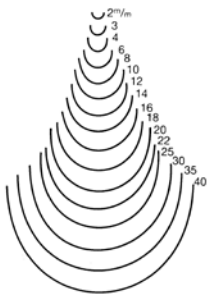

- 505-1102 .....Straight Gouge ..... 02mm
- 505-1103 .....Straight Gouge ..... 03mm
- 505-1104 .....Straight Gouge ..... 04mm
- 505-1106 .....Straight Gouge ..... 06mm
- 505-1108 .....Straight Gouge ..... 08mm
- 505-1110 .....Straight Gouge ..... 10mm
- 505-1112 .....Straight Gouge ..... 12mm
- 505-1114 .....Straight Gouge ..... 14mm
- 505-1116 .....Straight Gouge ..... 16mm
- 505-1118 .....Straight Gouge ..... 18mm
- 505-1120 .....Straight Gouge ..... 20mm
- 505-1125 .....Straight Gouge ..... 25mm
- 505-1130 .....Straight Gouge ..... 30mm
- 505-1135 .....Straight Gouge ..... 35mm



- 505-2006 ..... Curved Gouge..... 06mm
- 505-2010 ..... Curved Gouge..... 10mm
- 505-2012 ..... Curved Gouge..... 12mm
- 505-2014 ..... Curved Gouge..... 14mm
- 505-2016 ..... Curved Gouge..... 16mm
- 505-2020 ..... Curved Gouge..... 20mm
- 505-2025 ..... Curved Gouge..... 25mm



- 505-3204 ..... Spoon Bent Gouge .... 04mm
- 505-3206 ..... Spoon Bent Gouge .... 06mm
- 505-3208 ..... Spoon Bent Gouge .... 08mm
- 505-3210 ..... Spoon Bent Gouge .... 10mm
- 505-3212 ..... Spoon Bent Gouge .... 12mm
- 505-3216 ..... Spoon Bent Gouge .... 16mm
- 505-3218 ..... Spoon Bent Gouge .... 18mm

Quality Tools

75° Degree V-Tool #39

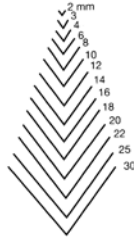

- 505-3902 ..... Straight V-Chisel ..... 02mm
- 505-3904 ..... Straight V-Chisel ..... 04mm
- 505-3906 ..... Straight V-Chisel ..... 06mm
- 505-3910 ..... Straight V-Chisel ..... 10mm
- 505-3914 ..... Straight V-Chisel ..... 14mm



- 505-4006 ..... Curved V-Chisel ..... 06mm
- 505-4012 ..... Curved V-Chisel ..... 12mm



- 505-4308 ..... Spoon Bent V-Chisel .. 08mm

60° Degree V-Tool #41



- 505-4102 ..... Straight V-Chisel ..... 02mm
- 505-4104 ..... Straight V-Chisel ..... 04mm
- 505-4106 ..... Straight V-Chisel ..... 06mm
- 505-4110 ..... Straight V-Chisel ..... 10mm
- 505-4114 ..... Straight V-Chisel ..... 14mm
- 505-4125 ..... Straight V-Chisel ..... 25mm



- 505-4206 ..... Curve V-Chisel ..... 06mm



- 505-4418 ..... Spoon Bent V-Chisel .. 18mm

100° Degree V-Tool #45

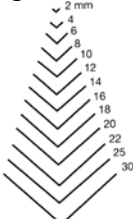

- 505-4502 ..... Straight V-Chisel ..... 02mm
- 505-4504 ..... Straight V-Chisel ..... 04mm
- 505-4512 ..... Straight V-Chisel ..... 12mm



- 505-4616 ..... Curved V-Chisel ..... 16mm

Grooving Tools #47

- U 1 mm
- U 1 1/2
- U 2



- 505-4701 ..... 1.0mm
- 505-4715 ..... 1.5mm
- 505-4702 ..... 2.0mm

Macaroni Tool

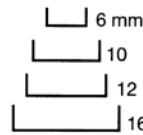

- 505-6006 ..... 06mm
- 505-6010 ..... 10mm
- 505-6012 ..... 12mm
- 505-6016 ..... 16mm

Swiss Pattern Fish Tail Tools

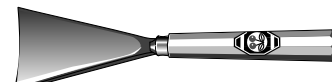

- 505-8150 ..... 50mm

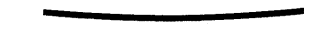

- 505-8350 ..... 50mm



- 505-8650 ..... 50mm



- 505-8750 ..... 50mm

Carving Tool Handle



The same handle as used on the full-size Two Cherries carving tools. Size indicated is the width of tool which the handle generally fits.

- 505-0091 ..... 2 to 10mm
- 505-0092 ..... 12 to 16mm
- 505-0093 ..... 18 to 22mm
- 505-0094 ..... 25 to 80mm

Professional Tool Sets

Twelve piece set is the start-up set, while the six piece set can be used as a beginning set, but is more useful as an add-on of larger tools to the twelve piece set.

Set of Twelve  
505-0012



505-0114



505-0206



505-0514



505-0516



505-0603



505-0610



505-0706



505-0814



505-1102



505-1406



505-2103



505-3906

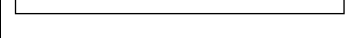

Set of Six  
505-0006



505-0214



505-0616



505-0806



505-1114



505-1610



505-3914





TWO CHERRIES CARVING TOOLS

Small Carving Tools



These smaller Two Cherries carving tools are the same quality as the larger professional tools shown on the previous pages, but fill the need for the occasional carver, and the carver doing smaller work. These are professional quality, smaller tools, polished all around. The blades are about 4" long and the overall length with handle is about 8".

All of these tools come with an octagonal shaped handle that you will find easy to work with.

Straight Chisel Edge



- 510-0102 ..... 2mm
- 510-0104 ..... 4mm
- 510-0106 ..... 6mm
- 510-0108 ..... 8mm
- 510-0110 ..... 10mm

Straight Skew Edge



- 510-0202 ..... 2mm
- 510-0204 ..... 4mm
- 510-0206 ..... 6mm
- 510-0208 ..... 8mm
- 510-0210 ..... 10mm

Straight, Very Shallow Gouge - Sweep 6



- 510-0602 ..... 2mm
- 510-0604 ..... 4mm
- 510-0606 ..... 6mm
- 510-0608 ..... 8mm
- 510-0610 ..... 10mm

Straight, Shallow Gouge Sweep 8



- 510-0802 ..... 2mm
- 510-0804 ..... 4mm
- 510-0806 ..... 6mm
- 510-0808 ..... 8mm
- 510-0810 ..... 10mm

Straight Gouge Sweep 10



- 510-1002 ..... 2mm
- 510-1004 ..... 4mm
- 510-1006 ..... 6mm
- 510-1008 ..... 8mm
- 510-1010 ..... 10mm

Curved, Very Shallow Gouge



- 510-1502 ..... 2mm
- 510-1504 ..... 4mm
- 510-1506 ..... 6mm
- 510-1508 ..... 8mm
- 510-1510 ..... 10mm

Curved, Shallow Gouge



- 510-1702 ..... 2mm
- 510-1704 ..... 4mm
- 510-1706 ..... 6mm
- 510-1708 ..... 8mm
- 510-1710 ..... 10mm

Curved Gouge



- 510-1902 ..... 2mm
- 510-1904 ..... 4mm
- 510-1906 ..... 6mm
- 510-1908 ..... 8mm
- 510-1910 ..... 10mm

Spoon Bent Straight Edge



- 510-2102 ..... 2mm
- 510-2104 ..... 4mm
- 510-2106 ..... 6mm
- 510-2108 ..... 8mm
- 510-2110 ..... 10mm

Spoon Bent, Very Shallow Gouge



- 510-2702 ..... 2mm
- 510-2704 ..... 4mm
- 510-2706 ..... 6mm
- 510-2708 ..... 8mm
- 510-2710 ..... 10mm

Spoon Bent, Shallow Gouge



- 510-2902 ..... 2mm
- 510-2904 ..... 4mm
- 510-2906 ..... 6mm
- 510-2908 ..... 8mm
- 510-2910 ..... 10mm

Spoon Bent, Gouge



- 510-3102 ..... 2mm
- 510-3104 ..... 4mm
- 510-3106 ..... 6mm
- 510-3108 ..... 8mm
- 510-3110 ..... 10mm

Straight V-Chisel



- 510-3902 ..... 2mm
- 510-3904 ..... 4mm
- 510-3906 ..... 6mm
- 510-3908 ..... 8mm
- 510-3910 ..... 10mm

Curved V-Chisel



- 510-4002 ..... 2mm
- 510-4004 ..... 4mm
- 510-4006 ..... 6mm
- 510-4008 ..... 8mm
- 510-4010 ..... 10mm

Spoon Bent V-Chisel



- 510-4302 ..... 2mm
- 510-4304 ..... 4mm
- 510-4306 ..... 6mm
- 510-4308 ..... 8mm
- 510-4310 ..... 10mm

Straight Grooving Gouge



- 510-4702 ..... 2mm
- 510-4704 ..... 4mm
- 510-4706 ..... 6mm
- 510-4708 ..... 8mm
- 510-4710 ..... 10mm



Carving Project

Based upon our experience this set provides the necessary materials and tools for the beginning wood carver. The project set contains a semi-finished wooden dolphin and a set of basic woodcarving tools, including three carving knives and one 6mm shallow gouge. Specifically, three carving knives 515-3351, 515-3353, 515-3356 and shallow gouge 510-0606. This set is packaged in a nice presentation carton so that it is perfect for giving to the soon-to-be wood-carver! Whether this is a kit for yourself or for a friend - both the tools and the finished project will be cherished for years to come.

515-3439 ..... Dolphin Carving Kit

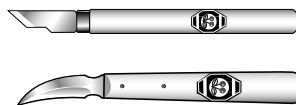

Four Piece Set



This four piece set is made to the highest standards of German quality by Two Cherries. This basic set contains a straight chisel (510-0108), medium gouge (510-0808), a V-chisel (510-3906) and chip carving knife (515-3352).

515-3424 ..... Small Set of 4

Seven Piece Set

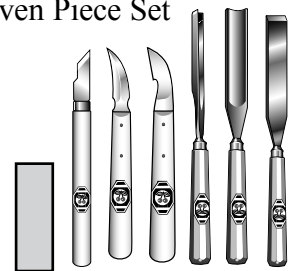

Great starter set comes with a straight chisel (510-0108), medium gouge (510-0806), V-chisel (510-3906), three chip carving knives (515-3351, 3353, 3358) and a sharpening stone! Perfect for the beginner woodcarver, or the woodworker that needs a few tools to use in adding carved details to their work.

515-3427 ..... Small Set of 7



TWO CHERRIES CARVING TOOLS

Pear Handled Carving Tools



For carvers that do mostly smaller work, where large amounts of wood are not being removed, these pear shaped handled chisels are perfect. The handle is shaped to be comfortable in the hand, and a flat on one side keeps the tool from rolling off the workbench. Each handle is protected with a high gloss finish. The blades are about 4" long and the overall length with handle is about 6 1/2".

These are the same blades found on the smaller octagon handled tools, and the blades keep to the exacting high standards found on all Two Cherries tools. Hand forged of high carbon steel, the blades are heat treated to sixty-one degrees Rockwell, and then ground and polished all around.

Straight Chisel Edge

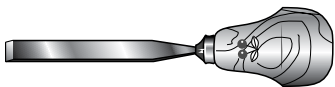

- |                    |                     |
|--------------------|---------------------|
| 511-0102 ..... 2mm | 511-0108 ..... 8mm  |
| 511-0104 ..... 4mm | 511-0110 ..... 10mm |
| 511-0106 ..... 6mm |                     |

Straight Skew Edge



- |                    |                     |
|--------------------|---------------------|
| 511-0202 ..... 2mm | 511-0208 ..... 8mm  |
| 511-0204 ..... 4mm | 511-0210 ..... 10mm |
| 511-0206 ..... 6mm |                     |

Straight Gouge Sweep 10



- |                    |                     |
|--------------------|---------------------|
| 511-1002 ..... 2mm | 511-1008 ..... 8mm  |
| 511-1004 ..... 4mm | 511-1010 ..... 10mm |
| 511-1006 ..... 6mm |                     |

Curved, Very Shallow Gouge

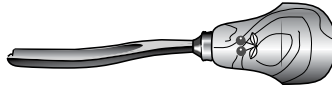

- |                    |                     |
|--------------------|---------------------|
| 511-1502 ..... 2mm | 511-1508 ..... 8mm  |
| 511-1504 ..... 4mm | 511-1510 ..... 10mm |
| 511-1506 ..... 6mm |                     |

Curved, Shallow Gouge



- |                    |                     |
|--------------------|---------------------|
| 511-1702 ..... 2mm | 511-1708 ..... 8mm  |
| 511-1704 ..... 4mm | 511-1710 ..... 10mm |
| 511-1706 ..... 6mm |                     |

Straight, Very Shallow Gouge - Sweep 6

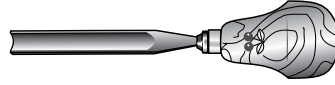

- |                    |                     |
|--------------------|---------------------|
| 511-0602 ..... 2mm | 511-0608 ..... 8mm  |
| 511-0604 ..... 4mm | 511-0610 ..... 10mm |
| 511-0606 ..... 6mm |                     |

Straight, Shallow Gouge Sweep 8



- |                    |                     |
|--------------------|---------------------|
| 511-0802 ..... 2mm | 511-0808 ..... 8mm  |
| 511-0804 ..... 4mm | 511-0810 ..... 10mm |
| 511-0806 ..... 6mm |                     |

Curved Gouge



- |                    |                     |
|--------------------|---------------------|
| 511-1902 ..... 2mm | 511-1908 ..... 8mm  |
| 511-1904 ..... 4mm | 511-1910 ..... 10mm |
| 511-1906 ..... 6mm |                     |

Spoon Bent Straight Edge



- |                    |                     |
|--------------------|---------------------|
| 511-2102 ..... 2mm | 511-2108 ..... 8mm  |
| 511-2104 ..... 4mm | 511-2110 ..... 10mm |
| 511-2106 ..... 6mm |                     |

Spoon Bent, Very Shallow Gouge



- |                    |                     |
|--------------------|---------------------|
| 511-2702 ..... 2mm | 511-2708 ..... 8mm  |
| 511-2704 ..... 4mm | 511-2710 ..... 10mm |
| 511-2706 ..... 6mm |                     |

Spoon Bent Shallow Gouge



- |                    |                     |
|--------------------|---------------------|
| 511-2902 ..... 2mm | 511-2908 ..... 8mm  |
| 511-2904 ..... 4mm | 511-2910 ..... 10mm |
| 511-2906 ..... 6mm |                     |

Spoon Bent, Gouge



- |                    |                     |
|--------------------|---------------------|
| 511-3102 ..... 2mm | 511-3108 ..... 8mm  |
| 511-3104 ..... 4mm | 511-3110 ..... 10mm |
| 511-3106 ..... 6mm |                     |

Straight V-Chisel



- |                    |                     |
|--------------------|---------------------|
| 511-3902 ..... 2mm | 511-3908 ..... 8mm  |
| 511-3904 ..... 4mm | 511-3910 ..... 10mm |
| 511-3906 ..... 6mm |                     |

Curved V-Chisel

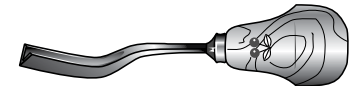

- |                    |                     |
|--------------------|---------------------|
| 511-4002 ..... 2mm | 511-4008 ..... 8mm  |
| 511-4004 ..... 4mm | 511-4010 ..... 10mm |
| 511-4006 ..... 6mm |                     |

Spoon Bent V-Chisel

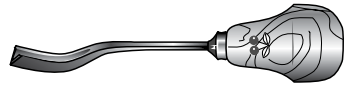

- |                    |                     |
|--------------------|---------------------|
| 511-4302 ..... 2mm | 511-4308 ..... 8mm  |
| 511-4304 ..... 4mm | 511-4310 ..... 10mm |
| 511-4306 ..... 6mm |                     |

Straight Grooving Gouge

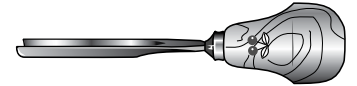

- |                    |                     |
|--------------------|---------------------|
| 511-4702 ..... 2mm | 511-4708 ..... 8mm  |
| 511-4704 ..... 4mm | 511-4710 ..... 10mm |
| 511-4706 ..... 6mm |                     |



Carving Tool Set

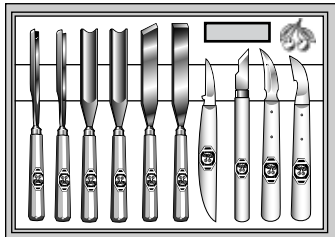

Ten Two Cherries carving tools along with a sharpening stone -- in a beautiful wooden storage box. Tools include gouges, skew, v-tool, and chip carving knives. This set will allow a wide variety of work to be performed, and is a great base upon which to build a larger collection of Two Cherries carving tools. It makes a splendid gift!

- 515-3441 ..... 11 Piece Set

Carving Tool Set



Handy set of seven high quality carving tools in a fitted wooden box. Set includes straight tool, medium gouge, V-chisel, three chip carving knives, and a sharpening stone. See item 515-3427 for exact specifications.

- 515-3437 ..... Carving Set 7 Pc Wood Box

Pear Handled Set in Wooden Box

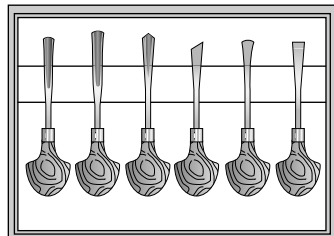

pear shaped handles. Blades are honed and can be used immediately. This beautiful set comes in a fitted wooden box for storage between carving sessions. See item 511-0050 for exact specifications.

- 511-0100 ..... Set of Six in Wood Box

Pear Handled Set



Set of six commonly used carving tools with pear shaped handles. Chosen from the selection of pear shaped handled tools on this page. Blades are honed and can be used immediately. Also available in an attractive and highly functional fitted wooden box. Contains chisels 511-0102, 511-0106, 511-0110, 511-0606, 511-0610, and 511-3904.

- 511-0050 ..... Set of Six



TWO CHERRIES CARVING TOOLS

Miniature Carving Tools



Have you ever needed a very small carving tool for working in limited access or on very small pieces of work? Finally, Two Cherries has provided the solution! Small octagon handles fit comfortably in the hand, and the balance of handle to blade is perfect. Still made in the same manner that makes all Two Cherries tools the finest in the world, with blades of high carbon steel, heat treated to take and hold an edge. Blades are approximately 2 1/4" long with overall tool length about 4 7/16". Item 515-8575 is illustrated above.

- 515-8500 ..... Set of Five (without case)
- 515-8575 ..... Set of Five in Leather Case

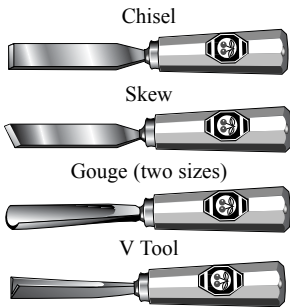

Key Chain



This is the only tool in this series of small tools that does not have a sharp edge. Perfect gift for the woodworker that has everything. Use it for the key to the shop!

- 515-3250 ..... Keychain

Micro Carving Knives

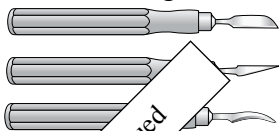

These micro carving knives will let you carve the finest detail that you would ever want to create.

- 515-3351 ..... Set of Three Knives
- 515-3352 ..... Straight Edge
- 515-3353 ..... Skew Edge
- 515-3380 ..... Bent Edge

rlc200906

Two Cherries Knives



The variety of styles found in these fine German knives will provide the carver and woodworker with the answer to most any cutting situation. Set of ten (515-3310) is available, containing all but the 515-3363 knife.

- 515-3310 ..... Set of Ten Knives

- 515-3351 ..... Chip Carving Knife
- 515-3352 ..... Chip Carving Knife
- 515-3353 ..... Chip Carving Knife
- 515-3354 ..... Chip Carving Knife
- 515-3356 ..... Chip Carving Knife
- 515-3357 ..... Chip Carving Knife
- 515-3358 ..... Chip Carving Knife
- 515-3360 ..... Chip Carving Knife
- 515-3361 ..... Chip Carving Knife
- 515-3362 ..... Chip Carving Knife
- 515-3363 ..... Chip Carving Knife

Chip Carving Set

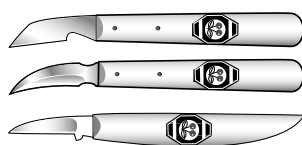

Set of three chip carving knives contains the popular models 515-3352, 515-3353, and 515-3358.

- 515-3303 ..... Set Of Three
- 515-3310 ..... Set of Ten Described Above

Micro Carving Tools

Like all other products made by Two Cherries, these tools are hand forged and finely polished. The blades are mounted on a specially designed wooden handle to give an easy-to-use feeling. The blades are approximately 60mm long on a handle of 110mm (about 170mm, or just under seven inches, overall). Fourteen different tools are available in either open stock or useful sets. These are the tools that woodcarvers have been looking for to work the details in their carving.

- 512-0015 ..... Curved Chisel 1.5mm
- 512-1115 ..... Straight Deep Gouge 1.5mm
- §512-0115 ..... Straight Chisel 1.5mm
- 512-1120 ..... Straight Deep Gouge 2.0mm
- 512-0215 ..... Skew Chisel 1.5mm
- 512-1510 ..... Curved Medium Gouge 1.0mm
- §512-0310 ..... Straight Shallow Gouge 1.0mm
- 512-2005 ..... Curved Deep Gouge 0.5mm
- §512-0610 ..... Straight Medium Gouge 1.0mm
- 512-2010 ..... Curved Gouge 1.0mm
- §512-1105 ..... Straight Deep Gouge 0.5mm
- §512-3915 ..... Straight V-Chisel 1.5mm
- §512-1110 ..... Straight Deep Gouge 1.0mm
- 512-4015 ..... Curved V-Chisel 1.5mm

Micro Carving Tool Sets



Set of six micro carving tools. Includes items marked § above.

- 512-5406 (Marked § above) ..... Set of Six



Set of six micro carving tools. Includes items marked • above.

- 512-5404 (Marked • above) ..... Set of Four

Micro Carving Tool Set in Wooden Box

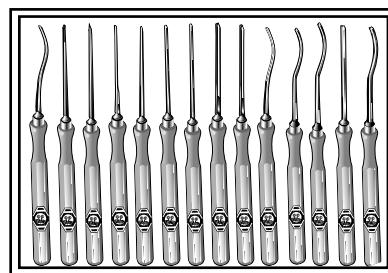

A complete set of fourteen micro carving tools in a fitted wooden box. With this complete set you can tackle most any small carving project that you can imagine!

- 512-5414 ..... Set of Fourteen



CARVING TOOLS

Wood Carving Tool Set

Here are two great beginner woodcarving sets. Both sets are light duty and low cost. Choose between a set with a regular handle or one with a palm grip type handle. Both sets contain the same blade configurations -- two chisels, two gouges, a skew, and a "V" tool. If you want to do some occasional carving, or want to try out carving for the first time, either of these sets will be perfect. Overall length is about six inches on the regular handled tool set, and a bit shorter on the palm grip.

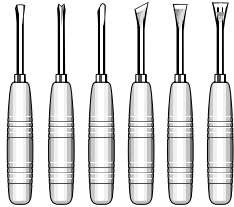

765-5000 ..... Regular Handled Set of Six

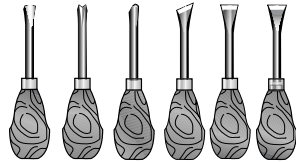

765-5100 ..... Palm Handled Set of Six

Power Grip Carving Tools

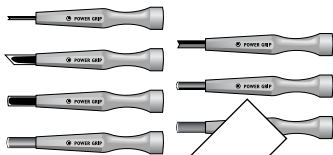

Shaped to comfortably fit the hand, this set of seven carving tools is ideal for teachers, students and carvers. Includes two shorter tools. The handles are made of Beech, blade length is 1 1/8". Overall length is 5 3/4". Set includes 1/8" #10 gouge, 1/4" #8 gouge, 3/8" #5 gouge, 3/8" #3 gouge, 3/16" straight chisel, 1/16" skew chisel and 1/4" V-parting tool. Set comes in a cardboard storage box with a plastic liner which secures each tool in place

765-4100 ..... Power Grip Set of Seven

Hand Guard

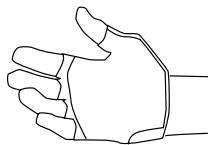

A protective guard for the entire palm, including the heel. Split leather pad can be worn under most gloves. One size fits all.

233-4010 ..... Shock Pad ..... Left  
233-4030 ..... Shock Pad ..... Right

Kevlar Gloves

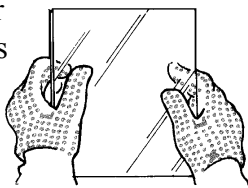

Kevlar®, the same Du Pont miracle fiber that makes police vests bullet-resistant, makes these gloves seven times more slash resistant than cotton gloves. They'll give your hands greater protection against slashes and cuts. Sold in pairs.

183-1000 ..... Small  
183-2000 ..... Medium  
183-3000 ..... Large

Japanese Carving Tools

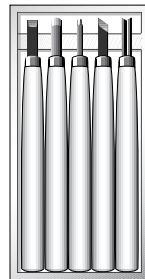

Economical set of five traditional style Japanese carving tools. Made of Yasuki special steel, the cutting edges are sharpened so that you can get to work right away. Comes in a fitted wooden case.

765-9100 ..... Set of Five Carving Tools

Thumb & Finger Guards



Comfortable fit provides controlled grip. Slip-on, hard-working, white grain leather guards. A must for carvers or anyone handling cutting tools on a regular basis.

233-1020 ..... Thumb Guard ..... Medium  
233-2020 ..... Finger Guard ..... Medium  
233-2500 ..... Thumb & Finger Guard Set

Shock Pad

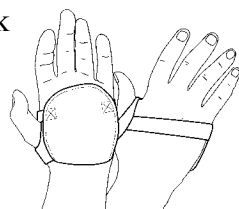

A reversible, split leather pad designed to absorb shock to the palm. Two wear surfaces make this pad suitable for either the right or left hand. One size fits all.

233-3020 ..... Shock Pad

**Dockyard Micro Carving Tools**  
Made in the U.S.A. to exacting specifications. Each tool is mounted on a 3/8" diameter octagon handle of Cherry wood. The overall tool length is approximately five inches.

Micro Carving Tools

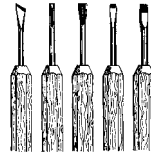

Set of five tools include plough, paring, 'V', 'U', and skew.

380-1000 ..... 3mm Standard Set  
380-2000 ..... 2mm Standard Set  
380-3000 ..... 1.5mm Standard Set

Micro Sculpture Set



Handy set of five tools. 2mm paring, 2mm 'V', and 2mm, 3mm, 4mm 'U'.

380-4000 ..... Sculpture Set

Micro Bench Chisels

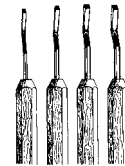

Four carefully made micro dog-leg bench chisels -- 2mm, 2.4mm, 2.75mm, and 3.25mm.

380-7000 ..... Bench Chisel

Micro Gouge Set



Five useful gouges in sizes 1.5mm, 2mm, 3mm, 4mm, and 5mm.

380-5000 ..... Gouge Set

Carving Tool Roll

Denim tool roll will hold twelve of the Dockyard Micro Carving tools.

170-2410 ..... Tool Roll

Micro Carving Tool Expansion Set

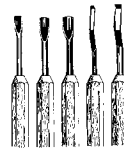

Five piece micro carving tool set contains tools in the 2.4 mm to 5mm size range.

380-6000 ..... Expansion Set

Micro Knife Set



Solve a big carving problem with this small knife set. Includes Sheep Foot, Angle Foot, and Hook.

380-9000 ..... Knife Set

Magnifying Hood

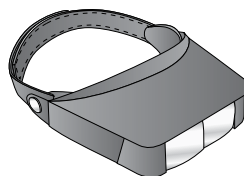

Lightweight, and with a wide-view, this magnifying headgear allows you to use both eyes at once for three-dimensional close-up viewing. Even fits over eyeglasses. Use the main lens for 2.2x magnification - quickly and easily lower the second lens to switch to 3.3x magnification. Especially useful for woodcarvers, this is the perfect answer for any type of close-up and intricate work.

665-1000 ..... Magnifying Hood

Whittling Kits



Created to show the way into the fascinating world of wood carving. Major facets are pre-cut, holes drilled, and, where called for, shoe laces, glass eyes, etc. are included. With EACH kit comes a small plastic model that shows how the kit should look when finished!

170-5010 ..... Owl  
170-5020 ..... Frog  
170-5030 ..... Indian  
170-5040 ..... Pelican  
170-5050 ..... Old Shoe  
170-5060 ..... Turtle  
170-5070 ..... Squirrel  
170-5080 ..... Duck





CARVING ACCESSORIES

"Wood is Good" Mallet

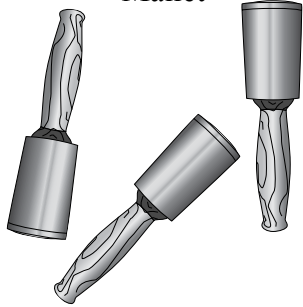

The "Wood is Good" mallet maintains the same hand grip on the wooden handle throughout the range of sizes - twelve ounces through thirty ounces. A long lasting tool that does not harm the chisel handle, and is easy on the carver's hand and arm during extensive carving sessions. This is thanks to the synthetic striking surface that will absorb shock before it can get to your arm, and yet transmits the striking force to the tool. USA

- 170-1012 ..... 12 oz
- 170-1018 ..... 18 oz
- 170-1020 ..... 20 oz
- 170-1030 ..... 30 oz

Carver's Scorp



A tool steeped in history and used for cutting or roughing out hollow areas. Useful for many carving applications including spoon making, bowls, chair seats and other creative purposes. The wood handle is a comfortable 4 1/2" long and the overall length of the tool is 7 1/2". The cutting edge is approximately 1" across when making a moderate cut.

- 515-2275 ..... Scorp

Bronze Head Mallets



The heavy, but compact bronze head mallet is ideal for striking use when a compact stroke or limited access area is being worked. Despite its size and weight, it is very controllable and lends itself to both full impact strikes as well as delicate tapping. Available in three weights and each comes with a storage pouch.

- 515-4380 ..... Bronze Mallet ..... 380 Grams
- 515-4550 ..... Bronze Mallet ..... 550 Grams
- 515-4750 ..... Bronze Mallet ..... 750 Grams

Stone Carving Tools

These fine stone carving tools come from a maker with over 100 years of experience. The tools are hand-forged and air-hardened C.V. steel and are tempered to RC 60. As a final step, they are polished and sharpened. They have octagonal shaped handles. Made in Austria.

- 823-1100 ..... Flat Chisel 6mm
- 823-1120 ..... Flat Chisel 13mm
- 823-1140 ..... Flat Chisel 20mm
- 823-1160 ..... Round Chisel 6mm
- 823-1180 ..... Round Chisel 13mm
- 823-1200 ..... Round Chisel 20mm
- 823-1220 ..... Gouge 6mm
- 823-1240 ..... Gouge 13mm
- 823-1260 ..... Gouge 20mm
- 823-1280 ..... Claw Chisel 12mm
- 823-1300 ..... Claw Chisel 20mm
- 823-1320 ..... Point Tool
- 823-1340 ..... Punch Tool 4mm

Carvers' Mallets

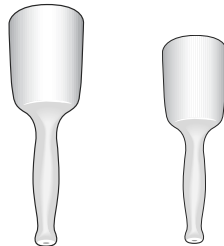

Hardwood carvers' mallets of traditional design. Available in two sizes which can vary slightly between mallets.

- 310-1065 ..... 3" Head ..... Small
- 310-1070 ..... 3 1/2" Head ..... Medium

Woodcarvers' Screw

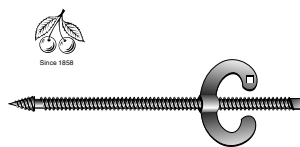

This is an exceptionally well made woodcarver's screw designed to hold projects to the bench top so that the carver has free access to the work from all sides.

- 515-3506 ..... Carver's Screw

Carving Stand

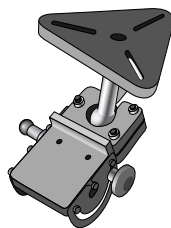

This is the perfect accessory for the serious carver. With this stand you can position your work in the absolute best position for accurate carving -- allowing you to do your finest work!

- 800-3650 ..... Carving Stand

Carvers Spoon



This is a very useful tool for hollowing out your work. The tool itself is made of solid brass. You will find a tremendous range of uses for this tool. Made in Taiwan.

- 825-6550 ..... Carvers Spoon

Carver's Drawknife



This is the perfect size drawknife for the woodcarver! The razor sharp edge is 100mm (4") in length. A nicely made tool that is hot-forged and specially sharpened on felt wheels. Protective leather case is included. Quality forged out of quality steel and well finished! Made in France. Be certain to see the wide selection of other drawknives elsewhere in this catalog.

- 847-1050 ..... Flat 100mm Drawknife

Wood Carver's Adze



Wood carver's adze are hand-forged from the toughest steel. Super keen edges and two sizes to choose from. Small adze has a 6 1/2" overall length head, while the larger head is 9". Curved blade on the small adze is 1", and the flat edge 1 3/4". Both blades on the larger adze are 2 3/4". Made in Austria.

- 310-1080 ..... Small Carver's Adze
- 310-1500 ..... Large Carver's Adze

Carver's Hook

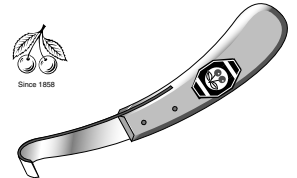

This can be an extremely helpful tool for working in hard-to-reach places of an intricate piece.

- 515-9710 ..... Right-hand
- 515-9715 ..... Left-hand
- 515-9720 ..... Combination

Sculpting Adze



These efficient adzes are designed for the fast removal of wood. The Sculpting Adze's cutting edge is approximately 2-3/4" and is available in two sweeps. The wood handles are sized for balance and the proper striking motion. Use either adze for shaping large pieces. Made in Austria.

- 823-2004 ..... 70mm Blade Sweep 4
- 823-2007 ..... 70mm Blade Sweep 7

Riffler Rasp Sets

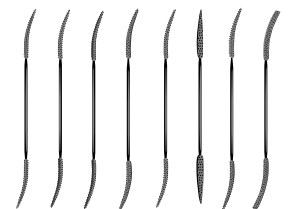

An economical set of riffler rasps for the beginner or occasional carver. Set of eight riffler rasps are made in China.

- 825-3600 ..... Riffler Rasp Sets



HIGH SPEED STEEL TURNING TOOLS

Robert Larson™ turning tools are manufactured to the highest quality. A wide variety of tools are available that will allow the best possible selection for the woodturner.

The Blades

The most important issue in a well-designed turning tool is the quality of the blade. All Robert Larson™ blades are manufactured to precise specifications.

The steel is M2 molybdenum based high speed steel which is machined from the solid in most cases. A few tools are entirely forged into shape. Next the tool is heat treated, being hardened and tempered to sixty-two degrees on the Rockwell "C" scale.

By no means is this the end of the manufacturing process as the blades are next machine ground and, in a number of cases, hand ground as well. The cutting edge is carefully ground, with this being followed by hand glazing and polishing of the tool surface. Polishing is linear to the blade length, unlike other manufacturers that leave circular polishing markings on the blade. In the case of fluted tools, polishing is accomplished with specially shaped abrasive impregnated rubber wheels.

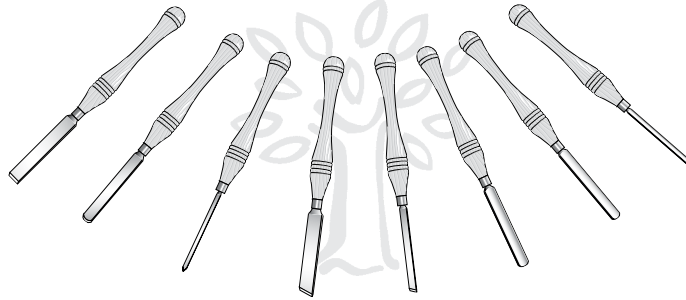

A thorough quality inspection is made on each and every tool before it is proudly marked HSS Steel, Made in Sheffield England.

The Handles

While the blades may be the most important part of a woodturning tool, the handle can make a tremendous difference in the accuracy of your turning, as well as how long you can turn before getting tired. Robert Larson™ turning tool handles were designed in consultation with a leading woodturning company (established

over a century ago) to provide both a firm as well as comfortable grip that will let you do your best work for hours on end! The handle starts with a blank of quality ash wood which is shaped into a unique style with beaded grips. While other manufacturers will apply a lacquer finish to the handle, our handles have an oil finish which provides a firmer grip. A solid brass sleeve is mounted on the front of the handle to strengthen the fitting of the blade tang into the handle. Each tool has been given the best size handle for the job.

Sets

A number of sets have been assembled to provide help in selecting the basic turning tools to begin your turning with. As you become more involved in turning simply add tools from the wide range available.

Options

If you are a woodturner that likes to "do-it-yourself" you will find that all of these quality tools are available unhandled! Choose your wood from commonly available hardwoods to exotic species to customize your woodturning tools by making your own handles. The brass sleeves we use on our handles are available as well.

Specifications

Each tool is listed with a part number, overall handle length, blade length without handle, and the cutting edge size.

Turning Tool Storage

Check out our tool roll and storage section for both leather and cloth turning tool rolls. These help protect and organize your investment in these fine

TURNING TOOL SETS

Set of Three Spindle Tools

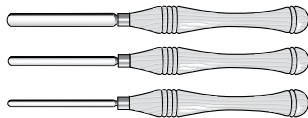

Spindle tools are possibly the most commonly used and useful tools available to the woodturner. This set of three tools contains 1/4", 3/8", 1/2" full-size spindle tools.

920-0375 .....Set/3 Spindle Tools

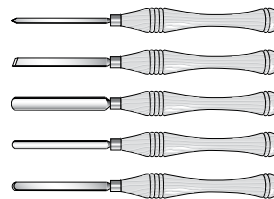

Set of Five

Great set for the beginning turner. Add more tools as your skill and needs grow. Includes 3/8" spindle gouge, 3/4" roughing out gouge, 1/2" skew chisels, 1/4" parting tool, and 1/2" round nose scraper.

920-0100 .....Set/5 Turning Tools

Set of Three Micro Spindle Tools

Here is a set of three micro spindle tools. Set contains 1/8", 5/32", and 3/16" tools, all mounted on six inch handles.

920-0350 .....Set/3 Micro Spindle Tools

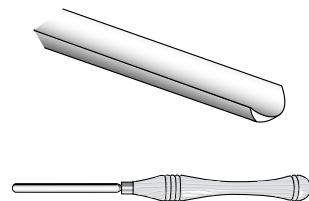

Set of Eight

This set will allow you to undertake a variety of scraping and cutting operations. Includes 1/4" and 1/2" spindle gouges, 3/4" roughing out gouge, 1/2" and 1" skew chisels, 1/4" parting tool, 3/4" round nose scraper, and 1" square nose scraper.

920-0150 .....Set/8 Turning Tools

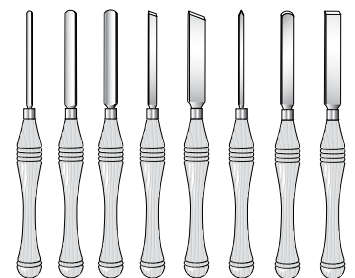

Set of Three Mid-Size Tools

Three of the most popular mid-sized tools. Great for those getting started with lathe turning. Includes the versatile 3/8" Bowl Gouge, the very useful 1/2" Oval Skew and the essential 1/8" Parting Tool. All have 6" handles.

920-0400 .....Set/3 Mid-Size Tools

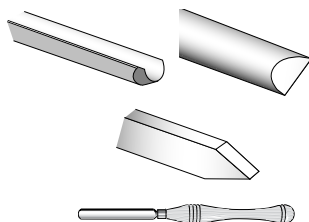

Miniature Set

If you enjoy doing smaller work, or take a great deal of time turning details on larger work, this will be an essential set of five tools. Includes 1/8" and 1/4" spindle gouges, 1/4" skew chisel, 2mm parting tool, and 1/4" round nose scraper.

920-0300 .....Set/5 Miniature Tools

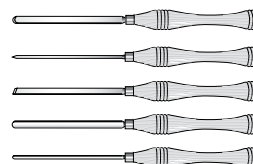



HIGH SPEED STEEL TURNING TOOLS

Spindle Gouge

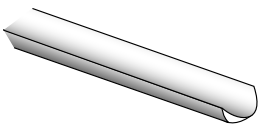

This well established, basic tool is used for a wide variety of work, including light roughing work and finishing between centers. A lighter and shorter tool than bowl gouges.

- 920-0530 ..... 10" ..... 200mm ..... 1/4" (6mm)
920-0535 ..... 10" ..... 200mm ..... 3/8" (10mm)
920-0540 ..... 10" ..... 200mm ..... 1/2" (13mm)
920-0545 ..... 14" ..... 300mm ..... 1/2" (13mm)
920-0550 ..... 10" ..... 200mm ..... 3/4" (19mm)
920-0555 ..... 14" ..... 200mm ..... 1" (25mm)

Bowl Gouge

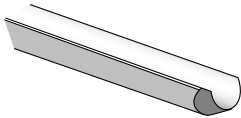

Indispensable, traditional tool with a round and thicker profile for making bowls. The 1/4" gouge is for more delicate work and the 1/2" and 3/4" gouges are for roughing out and general work.

- 920-1010 ..... 14" ..... 300mm ..... 1/4" (6mm)
920-1015 ..... 14" ..... 300mm ..... 3/8" (10mm)
920-1020 ..... 14" ..... 300mm ..... 1/2" (13mm)
920-1025 ..... 16" ..... 300mm ..... 3/4" (19mm)

Parting Tool

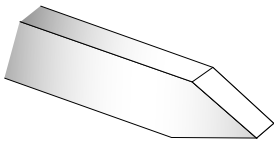

Traditional rectangular cross-sectioned tool used to part, or separate, work-pieces done between centers.

- 920-4525 ..... 10" ..... 150mm ..... 1/8" (3mm)
920-4530 ..... 10" ..... 200mm ..... 1/4" (6mm)

Round Nose Scraper

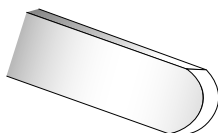

A very useful scraper for spindle and face turning work. Designed for concave shaped surfaces and general embellishments.

- 920-5015 ..... 10" ..... 200mm ..... 1/2" (13mm)
920-5020 ..... 10" ..... 200mm ..... 3/4" (19mm)
920-5025 ..... 10" ..... 200mm ..... 1" (25mm)
920-5030 ..... 14" ..... 200mm ..... 1 1/4" (32mm)

rlc200906

Roughing Out Gouge

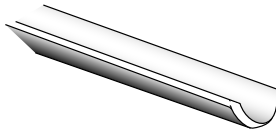

One of the basic and necessary turning tools for both beginners and advanced turners. Used to remove waste from spindle and faceplate turnings.

- 920-1510 ..... 10" ..... 150mm ..... 1/2" (13mm)
920-1515 ..... 10" ..... 200mm ..... 3/4" (19mm)
920-1520 ..... 14" ..... 200mm ..... 1 1/4" (32mm)

Oval Skew

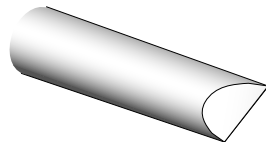

The oval skew offers smooth usage and won't cut into the tool rest. It is also quite nice for shaping beads and cylinders.

- 920-2010 ..... 10" ..... 200mm ..... 1/2" (13mm)
920-2015 ..... 10" ..... 200mm ..... 3/4" (19mm)
920-2020 ..... 14" ..... 200mm ..... 1" (25mm)
920-2025 ..... 14" ..... 200mm ..... 1 1/4" (32mm)

Diamond Side Cutting Scraper

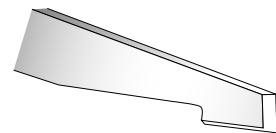

Designed to undercut when making square edges or corners at the bottom of boxes. The square shape allows for smoothing straight side walls.

- 920-6510 ..... 10" ..... 200mm ..... 3/4" (19mm)

Bedan Tool

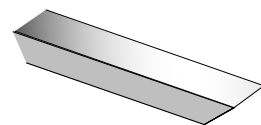

This parting tool quickly makes accurate and repetitive sizing cuts on spindles. It's outstanding when making bead cuts or smoothing small diameter spindles. The tool's sides slope inward to reduce potential binding.

- 920-7010 ..... 10" ..... 266mm ..... 3/8" (10mm)

Skew Chisel

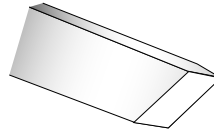

An essential turning tool: the skew chisel is used for paring and trimming surfaces. Also for shaping beads and other detail configurations.

- 920-2515 ..... 10" ..... 200mm ..... 1/2" (13mm)
920-2520 ..... 10" ..... 200mm ..... 3/4" (19mm)
920-2525 ..... 10" ..... 200mm ..... 1" (25mm)
920-2530 ..... 14" ..... 200mm ..... 1 1/4" (32mm)

Skew - Rounded Edge

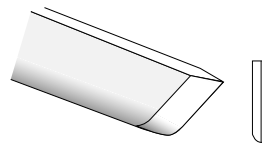

Instead of a flat bottom edge, this skew has a rounded surface which permits the tool to smoothly roll and slide on the tool rest. It offers superior performance when making rolling cuts as is done when beading.

- 920-3010 ..... 10" ..... 200mm ..... 1/2" (13mm)
920-3015 ..... 10" ..... 200mm ..... 3/4" (19mm)
920-3020 ..... 10" ..... 200mm ..... 1" (25mm)
920-3025 ..... 14" ..... 200mm ..... 1 1/4" (32mm)

Square Nose Scraper

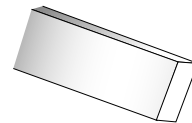

The square nose scraper is an essential tool used to improve the surface of flat bottoms in boxes or make straight cuts down the side of boxes or hollow cylinders. It is also excellent for outside faceplate work.

- 920-5510 ..... 10" ..... 200mm ..... 1/2" (13mm)
920-5515 ..... 10" ..... 200mm ..... 3/4" (19mm)
920-5520 ..... 10" ..... 200mm ..... 1" (25mm)
920-5525 ..... 14" ..... 200mm ..... 1 1/4" (32mm)

Round Nose Side Cutting Scraper

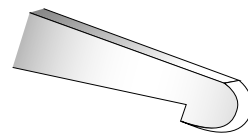

Designed to undercut when making vessel or bowl openings or lips. The round shape allows for radius undercuts and smoothing curved side walls.

- 920-6010 ..... 10" ..... 200mm ..... 1/2" (13mm)
920-6015 ..... 10" ..... 200mm ..... 3/4" (19mm)
920-6020 ..... 10" ..... 200mm ..... 1" (25mm)

Long & Strong Skew

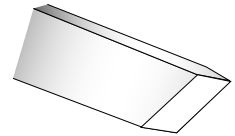

This tool's weight and strength reduces flexing and chattering while permitting better leverage with a stronger working edge.

- 920-3510 ..... 14" ..... 300mm ..... 3/4" (19mm)
920-3515 ..... 14" ..... 300mm ..... 1" (25mm)
920-3520 ..... 16" ..... 300mm ..... 1 1/4" (32mm)

Long & Strong Skew with Rounded Edge

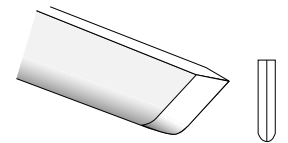

This tool has all the features as the above mentioned tool, plus the advantage of a round shaped bottom edge. This makes tool movement smoother and also minimizes wear on the tool rest.

- 920-4020 ..... 16" ..... 300mm ..... 1 1/4" (32mm)

Diamond Parting Tool

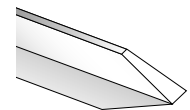

A first rate variation of the standard parting tool. The tool's cutting edge is 3/16" wide and tapers to less than 1/8" at the top and bottom thus reducing the cross sectional profile and reducing friction when parting.

- 920-4510 ..... 10" ..... 200mm ..... 3/16" (5mm)

Fluted Parting Tool

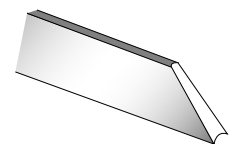

A uniquely designed parting tool featuring a radius groove at the cutting edge with two spur-like points to score the wood before the center radius makes the parting cut thus reducing or eliminating end-grain tearing. The tool's taper profile also reduces friction.

- 920-4515 ..... 10" ..... 200mm ..... 3/16" (5mm)



HIGH SPEED STEEL TURNING TOOLS

Beading & Parting Tool

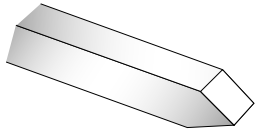

A 3/8" square chisel used for sizing, making beads or v-grooves on cylinders between centers.

920-7510 ..... 10" ..... 266mm ..... 3/8" (10mm)

Combination Ring Tool

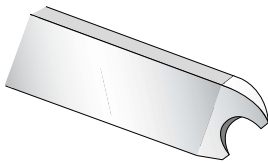

A specialized tool for making loose decorative rings which are captive to the neck of a vase or goblet.

920-8010 ..... 10" ..... 200mm ..... 1/4" (6mm)  
920-8015 ..... 10" ..... 200mm ..... 3/8" (10mm)  
920-8020 ..... 10" ..... 200mm ..... 1/2" (13mm)

Bowl Scraper

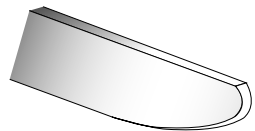

The gradient shape of the bowl scraper is ideal for shear scraping curved bowl walls. This unique cutting edge design reduces the tendency associated with straight edge tools of digging into curved surfaces.

920-8510 ..... 14" ..... 200mm ..... 1 1/2" (32mm)

Heavy Duty Scraper

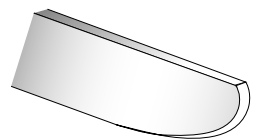

A larger and heavier version of the bowl scraper. The weight and size helps to reduce vibration and tool chatter when performing the final smooth finishing of a turning.

920-9010 ..... 16" ..... 254mm ..... 1 1/2" (38mm)

Round Skew Chisel

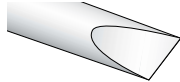

Designed to overcome the limitations of square skew tools, the round shape permits more maneuverability while sliding smoothly on the toolrest. The round shape is also very strong and tends to dampen vibrations while producing smooth wood surfaces. The skew shape, besides making smoothing cuts, is easily used to form beads. Available in three worthwhile sizes.

920-9510 ..... 10" ..... 150mm ..... 1/4" (6mm)  
920-9515 ..... 10" ..... 175mm ..... 3/8" (10mm)  
920-9520 ..... 10" ..... 200mm ..... 1/2" (13mm)

Shear Scrapers

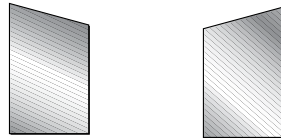

Left to Right

Right to Left

The ideal tools for smoothing the rough surface left by gouges. These are thick and heavy and made to minimize vibrations while producing flawless surfaces, especially on the outer surfaces of bowls. Available for smoothing actions, Left to Right and Right to Left.

920-5610 ..... 10" ..... 200mm ..... L-R-1"  
920-5620 ..... 10" ..... 200mm ..... R-L-1"

Box Scrapers

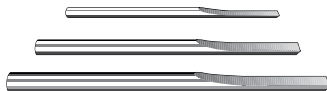

The box scraper is ideal for cleaning up rough end grain in open turnings, such as, goblets, boxes or other vessels. It is made from round stock, facilitating a smooth rolling action on the lathe rest and when making shear scraping types of cuts on end grain. Available in three sizes for different sized work.

920-5810 ..... 10" ..... 150mm ..... 1/4"  
920-5820 ..... 10" ..... 175mm ..... 3/8"  
920-5830 ..... 10" ..... 200mm ..... 1/2"

Dovetail Tool

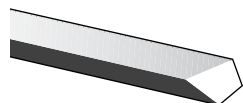

This tool is designed to quickly make a precision fit dovetail recess for chuck jaws.

920-6350 ..... 10" ..... 200mm ..... 3/8"

Diamond Point Tool

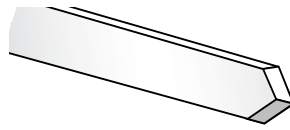

A favorite tool of experienced turners and one of the basic turning tools for beginners. Useful for a variety of applications, including fitting lids on boxes, truing tenons and recesses, making jam chucks and shear scraping on the outside of small pieces. Highly recommended.

920-6550 ..... 10" ..... 200mm ..... 1/2"

Wedge Tools



Easy to use tool which leaves a smooth surface. It's used to create coves in spindle work but it is also useful as a scraping and cutting tool in both spindle and faceplate work. The cutting surface is flat thus reducing the tool's catching or digging into the turning surface.

920-7410 ..... 10" ..... 200mm ..... 3/8"  
920-7420 ..... 10" ..... 200mm ..... 1/2"

Ring Tools



A tool specially designed to hollow into end grain and leave a smooth cut. It is also a useful tool for bowls, goblets and other vessel shapes.

920-8210 ..... 10" ..... 200mm ..... 1/2"  
920-8220 ..... 14" ..... 300mm ..... 1"

Hollowing Tools

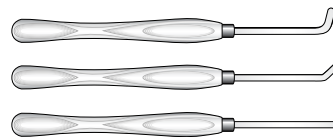

Three different shapes are offered for working within vessels or bowls. The two bent hollowing tools are designed for enclosed structure turning while the straight hollowing tool can be used for any turning where access is limited.

920-5310 ..... 6" ..... 125mm ..... Straight  
920-5320 ..... 6" ..... 125mm ..... 45° Bent  
920-5330 ..... 6" ..... 125mm ..... 80° Bent

Groove Forming Tools

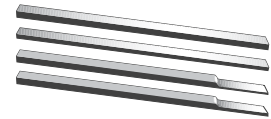

A smaller type of tool for shaping grooves, parting small workpieces and decorative scraping work. These are complimentary to both larger and miniature sized tools. Available in four sizes.

920-6310 ..... 6" ..... 125mm ..... 1 mm  
920-6320 ..... 6" ..... 125mm ..... 2 mm  
920-6330 ..... 6" ..... 125mm ..... 3 mm  
920-6340 ..... 6" ..... 125mm ..... 4 mm

Spiral Shell Auger Bit



An improved design for boring long holes. The spiral shape facilitates the removal of waste material thus reducing the frequency of pulling it out of the hole for cleaning. Because the boring process is done by hand, a handle needs to be used, preferably one with sufficient length and diameter. The bit is 26" in overall length, and is fitted to a ten inch handle.

920-9806 ..... 3/8"

The Art of Segmented Wood Turning

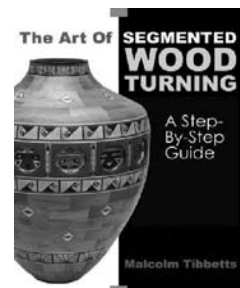

The definitive text on segmented turning. Tibbetts discusses various types of construction, staved, and ring design as well as the difference between inlaid and segmented lamination. Detailed explanations on how to proceed with this highly visual form of turning. Includes what woods to use, glue types, creating a blueprint for your work, building a vessel, shortcuts, building a stave constructed vessel, and building an Indian blanket design ring.

415-1660 ..Art of Segmented Wood Turning





TURNING TOOLS & ACCESSORIES

Replacement Handles

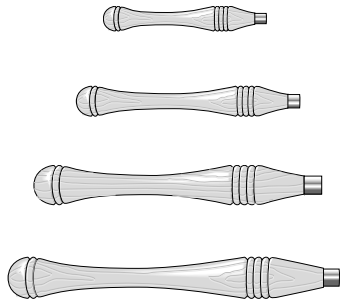

Same ash handle, with brass sleeve and oil finish, found on all Robert Larson™ woodturning tools.

- 926-8010 ..... 6"
- 926-8020 ..... 10"
- 926-8030 ..... 14"
- 926-8040 ..... 16"

Brass Sleeves

Solid brass sleeves or ferrules for making your own turning tool handles. Tumble polished. All measurements are in inches.

- 926-9010 ..... 0.5625 od 0.500 id 0.4375 long
- 926-9020 ..... 0.750 od 0.6875 id 0.6875 long
- 926-9030 ..... 1.00 od 0.9375 id 0.875 long
- 926-9040 ..... 1.125 od 1.00 id 0.875 long

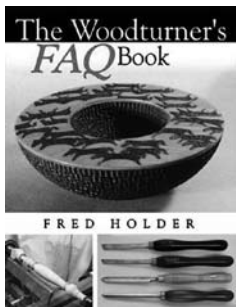

The Woodturners FAQ Book

Aimed at beginning turners, this woodturning primer covers all the basics needed to get started, such as type of lathe, tools and chucks needed, which accessories are handy to have, how to sharpen, differences in various grinding systems, where to obtain wood, and which wood to use.

415-1750 ..... The Woodturners FAQ Book

Center Finder

veritas®



Set square or cylinder work (up to 6" across) in the marker, tap it with a mallet, turn the wood ninety degrees and tap it again. The knife-edged blade scores the dead-center of the wood.

860-1200 ..... Center Marker

Mid-Size Tools

Three different mid-size tools. These turning tools are a little shorter than their full-size counterparts and can be extremely useful for smaller turnings, including pen turning. All three tools are fitted to a six inch handle.

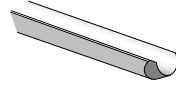

920-1050 ..... Mid-Size Bowl Gouge 3/8"

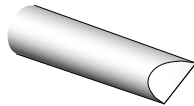

920-2050 ..... Mid-Size Oval Skew 1/2"

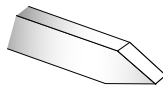

920-4550 ..... Mid-Size Parting Tool 1/8"

Miniature Tools

Small tools for small work or details on larger pieces. The blades without handles are an overall 125 mm in length, then mounted on our six inch handle.

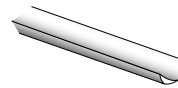

- 920-0510 ..... 6" ..... 125mm ..... 1/8" (3mm)
- 920-0515 ..... 6" ..... 125mm ..... 5/32" (4mm)
- 920-0520 ..... 6" ..... 125mm ..... 3/16" (5mm)
- 920-0525 ..... 6" ..... 125mm ..... 1/4" (6mm)

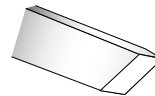

920-2510 ..... 6" ..... 125mm ..... 1/4" (6mm)

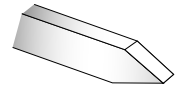

920-4520 ..... 6" ..... 125mm ..... 2mm

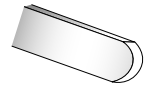

920-5010 ..... 6" ..... 125mm ..... 1/4" (6mm)

Unhandled Tools

All of these HSS turning tools are also available without handles. To order any tool without a handle, simply replace the first section of the part number (920) with the number 925. For instance, to order the 1/4" spindle gouge without handle simply order 925-0530 instead of 920-0530.

Turner's Sizing Caliper

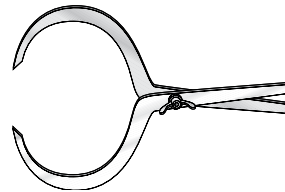

These high quality French turner's calipers make gauging the thickness of a turned bowl easy and fast. Simply close the caliper on the piece being gauged and measure the thickness on the other end of the caliper!

Maximum:	Inside	Outside
850-2222	110mm	170mm
850-2225	125mm	200mm
850-2230	150mm	250mm
850-2240	200mm	350mm
850-2250	500mm	450mm

Turner's Sanding Pack



This dispenser contains four one inch by twenty foot rolls of cloth backed aluminum oxide abrasive. Contains rolls of 150, 220, 320, and 400 grit abrasive. The convenient design allows you to quickly obtain the length of abrasive you need.

825-2200 ..... Turner's Sanding Pack

Scraper Burnisher

veritas®



This tool turns scrapers into cutters. Turners who are used to using scrapers with a grinder produced burr will be amazed at the difference a smooth edge-hook can make. After grinding the scraper you simply deburr the flat face and roll a hook on the edge. The pressure that you use determines the size of the hook. Designed for use with either full size, miniature, high speed, or carbon steel tools.

860-2250 ..... Scraper Burnisher

Moisture Meter

Comes with two sets of probes that allow the meter to measure moisture content at depths of 3/16" and 7/16". As probes are pressed into the wood, an on-off switch between the pins turns the meter on automatically. The moisture content is indicated in percent by a red LED light. In case of interim values, two LED's light up at the same time. Powered by one nine volt battery. Meter will read from 6% to 20% moisture range. Lignomat

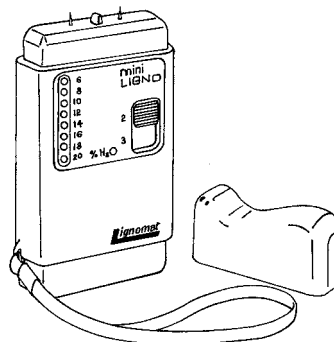

- 180-0000 ..... Moisture Meter
- 180-1350 ..... Short 3/16" Pins Only - Pair
- 180-1400 ..... Long 7/16" Pins Only - Pair

# Robert Larson Company

## SJÖBERGS BIRCH WORKBENCHES



Sjöbergs has been manufacturing cabinet maker's benches for over eighty years, for professionals, DIY enthusiasts, and schools. The company also produces a wide range of accessories for their benches - making them all the more useful. All development and production takes place in Stockaryd, Småland, Sweden. Sjöbergs are proud of that, and their tradition of knowledge in producing workbenches that work for you. They maintain full control of production so the products retain excellent quality. The fact that they offer a ten-year guarantee is the assurance you want and deserve. You will be satisfied with your Sjöbergs product and will find that your woodworking will be even more fun and satisfying. A great bench will help you make great work.

### Nordic Plus . . . The new generation!

Based upon the latest Sjöbergs design, the Nordic Plus range gives you the size you need at a price you can afford. The amazing versatility of vise location permits left or right handed use or clamping on both ends, or dual clamping on the front. The top is made of panel-glued European birch to withstand rough treatment. The sturdy trestles are made from Nordic pine. All the wood is FSC certified which guarantees forestry renewal. This hard Nordic birch top is built to last a lifetime of normal use, and has a double row of 3/4" clamping holes working from each of the four vise locations, giving an endless opportunity to clamp your work.

#### Nordic Plus 1950



Specification	MM	Inches
Length of worktop	1840	72½
Total length (2 vises)	2100	82¾
Total length (1 vise)	1970	77½
Width of worktop	500	19½
Total width	630	24¾
Vise capacity	115	4½
Working height	860	33¾
Weight	36 kg	79 lbs
995-1500	Nordic Plus 1950 Bench	

#### Nordic Plus 1660



Specification	mm	inches
Length of worktop	1550	61
Total length (2 vises)	1810	71¼
Total length (1 vise)	1680	66½
Width of worktop	500	19½
Total width	630	24¾
Vise capacity	115	4½
Working height	860	33¾
Weight	33 kg	73 lbs
995-1250	Nordic Plus 1660 Bench	

#### Nordic Plus 1450



Picture above shows cupboard which is an optional accessory that will fit any Nordic Plus bench.

Specification	mm	inches
Length of worktop	1340	52¾
Total length (2 Vises)	1600	63
Total length (1 Vise)	1470	57½
Width of worktop	500	19½
Total width	630	24¾
Vise capacity	115	4½
Working height	860	33¾
Weight	30 kg	66 lbs
995-1000	Nordic Plus 1450 Bench	

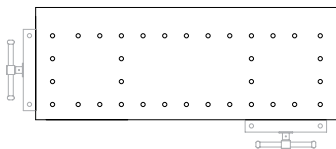

Left Hand Vise Configuration

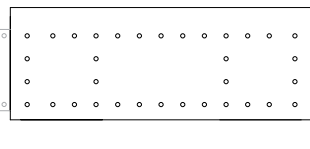

Both Vises on Ends

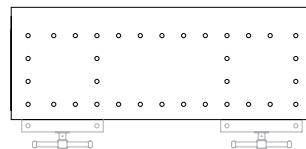

Both Vises on Front

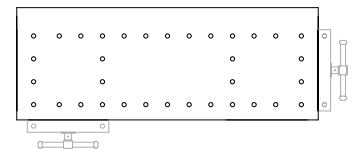

Right Hand Vise Configuration

Hard Nordic birch top, built to last a lifetime of normal use. There is a double row of 3/4" clamping holes working from each of the four vise locations, giving an endless opportunity to clamp your work. A number of sturdy accessories allow you to clamp and work easily on most almost project that you undertake.

### Nordic Plus Accessories

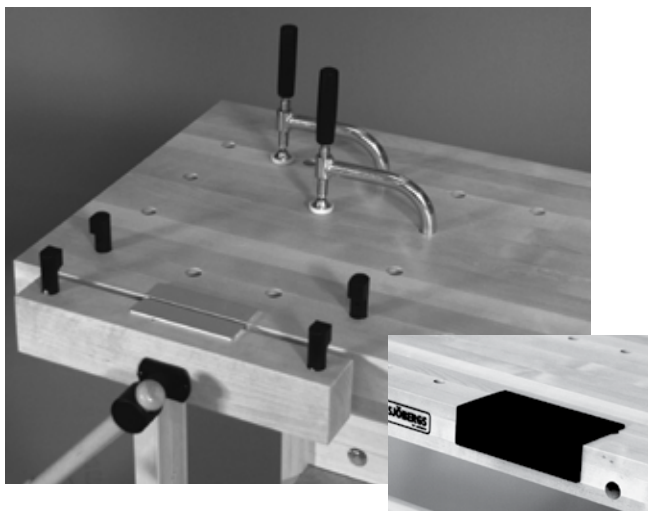

Holdfasts can be located in any of the dog holes on worktop or in the holes on the front legs of the trestle. Fit any 3/4" dog hole.  
995-5100 ..... Holdfast (pair)

Bench Dogs 3/4" by 4". Steel core with plastic coating to protect edge tools and reversible for thin work.  
995-5200 ..... Bench Dogs 3/4" (Set/4)

Aluminum Jaw Protectors hold small pieces more easily, or metal parts, so as not to mar the wooden vise jaws.  
995-5400 ..... Jaw Protectors (pair)

Protect your bench top by using this wrap-around Anvil that locks into any dog hole.  
995-5300 ..... Anvil

### Cupboard



Add this storage module that will help to keep your workshop more organized. Easily added to any of the Nordic Plus benches, this module adds four drawers and a generous cupboard space.  
995-2000 ..... Cupboard for Nordic Plus

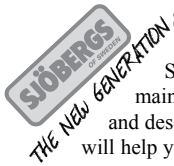

Sjöbergs has been manufacturing cabinet maker's benches for over eighty years, for professionals, DIY enthusiasts and schools. The company also produces a wide range of accessories for their benches - making them all the more useful. All development and production takes place in Stockaryd, Småland, Sweden. Sjöbergs are proud of that, and their tradition of knowledge in producing workbenches that work for you. They maintain full control of production so the products retain excellent quality. The fact that they offer a ten-year guarantee is the assurance you want and deserve. You will be satisfied with your Sjöbergs product and will find that your woodworking will be even more fun and satisfying. A great bench will help you make great work.

### Sjöbergs Elite . . . The new generation!

European bench making at its finest! These two Swedes are smarter than any alternatives on the market. Sjöbergs Elite cabinetmaker benches are designed and built by the finest Swedish benchmarking craftsmen to be found.

Constructed in European beech. The top is 85 mm (3") in the centre with a 110 mm (4") skirt, and treated with a premium quality enriching oil. The specially developed vises provide an enormous clamping power across 600 mm (23 1/2"). You will be amazed by the clamping speed, accuracy and smoothness. Bench comes with four 1" steel bench dogs.

Suitable for right or left handed persons! In less than two minutes, the front vise can be fitted on either side. A double row of 1" (25.4 mm) round dogs work from both vises. With the new high speed holdfast, you can clamp your work in a split second using any dog hole or the holes in the trestle. With a large range of accessories, your Sjöbergs Elite bench will be the perfect foundation for your workshop.

#### Elite 2500



Picture above shows cupboard SM-04 which is an optional accessory that will fit either Elite bench.

Specifications	mm	inches
Length of worktop	2380	93 3/4
Total length	2520	99 1/4
Width of worktop	600	23 3/8
Total width	740	29 1/8
Thickness of worktop	85	3 1/2
Thickness of skirt	110	4 1/8
Vise capacity	145	5 3/4
Working height	900	35 1/8
Weight	140 kg	308 lbs
<b>995-3000</b>	<b>Elite 2500 Bench</b>	

#### Elite 2000



Specifications	mm	inches
Length of worktop	1805	71 1/2
Total length	1945	76 9/16
Width of worktop	600	23 3/8
Total width	740	29 1/8
Thickness of worktop	85	3 1/2
Thickness of skirt	110	4 1/8
Vise capacity	145	5 3/4
Working height	900	35 1/8
Weight	122 kg	268 lbs
<b>995-3250</b>	<b>Elite 2000 Bench</b>	

### Sjöbergs Duo

This is a lighter bench than the Elite line, but made of the same quality beech wood and the same high manufacturing quality. The Duo is supplied with four vise locations for left or right handed use. Includes eight bench dogs, two holdfasts, and jaw protectors.

#### Duo 1500

Shown with the optional storage module SM-03.



Specifications	mm	inches
Length of worktop	1340	53
Total length (two vises)	1600	63
Width of worktop	537	21
Total width	667	26
Thickness of worktop	28	1 1/16
Thickness of skirt	70	2 3/4
Vise capacity	115	4 1/2
Working height	860	34
Weight	43 kg	95 lbs
<b>995-4000</b>	<b>Duo 1500 Bench</b>	

### Duo Accessories



995-4250 ..... Cupboard SM-03 for Duo

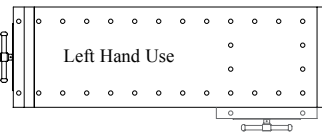

Both Elite benches can be outfitted for both left and right handers. Just takes a few minutes to make the change.

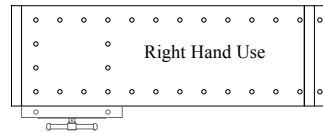

#### Bench Dogs



Four heavy duty bench dogs that can be used on the bench top or on the trestle.

- 995-6200 ..... 1" Steel Dogs (four)
- 995-6250 ..... 1" Aluminum Dogs (four)

#### Holdfast



High speed holdfast, Clamp your work in a split second using any dog hole or the holes in the trestle at the front of the bench.

- 995-6100 ..... Quick Acting Holdfast rlc200906

#### Storage Module



Keep your workshop area organized with this beautifully made and useful storage module. In addition to an open cupboard, you get six drawers that will help you find the tool you need when you need it. Easily installed on either of the two Elite workbenches.

- 995-3500 ..... Storage Module SM-04

#### Anvil



Some operations might mar your bench top, so add an anvil to protect it.

- 995-6300 ..... Anvil

#### Spare Vise & Jaw Protectors



Extremely strong and easy to fit spare vise. Huge resistance to racking.

- 995-6500 .. Spare Vise (wood not included)



- 995-5100 ..... Holdfast (2 pack)



- 995-5300 ..... Anvil



- 995-5200 ..... 3/4" Bench Dogs (4 pack)





**Marking Gauge**

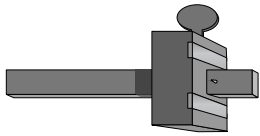

Essential for marking parallel lines to an edge with the grain. Made from the best quality beech, this marking gauge features a square head with inset brass wear plates, and locks with a thumbscrew so that no screwdriver is needed. Overall size is approximately 9", and tool is made in England.

605-1050 ..... Beechwood Marking Gauge

**Cutting Gauge**

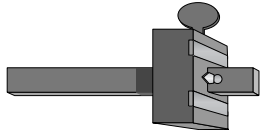

Made from the best quality beech, this cutting gauge features a square head with inset brass wear plates, and locks with a thumbscrew so that no screwdriver is needed. The tool is used for scoring across the grain, and it can also be used for cutting strips of wood veneer and small rebates. The cutter is securely held in place by a brass wedge, which enables the cutter to be removed for sharpening. Overall size is approximately 9", and tool is made in England.

605-1100 .....Beechwood Cutting Gauge

**Mitre Squares**



Accurate marking of mitre joints at 45° and 135° angles. Same high quality as our rosewood try squares using the best quality rosewood and tempered steel blades. Blade is securely held by steel rivets with surrounding inlaid brass diamonds. Made in England.

605-2300 .....Rosewood 10" Mitre Square



Miniature version for model making, or other small work. Round rivets hold the blade in place. Made in England.

605-4050 ..... 4 1/2"

**Mortise Gauges**

A selection of mortise gauges, all of the highest quality and made for discriminating craftsmen by craftsmen in Sheffield, England.

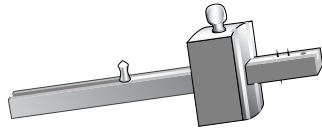

Highest quality beechwood has brass wear strips on the rubbing face. One side is for marking mortises and has a sliding adjustment mechanism. The other side has a single pin which allows the tools to be used as a traditional marking gauge. Thumbscrew locking mechanism. Overall size is approximately 7 1/4"

605-1250 ..... Beechwood Gauge

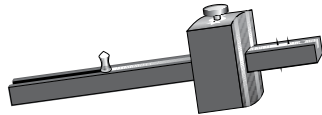

Similar to the beechwood mortise gauge above, but made from the finest rosewood available. Also features a knurled brass thumbscrew for locking the gauge in place. Overall size is approximately 7 3/4"

605-1150 ..... Rosewood Gauge

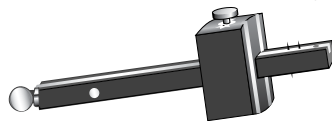

Here is an exquisite tool that is easy to adjust and wonderful to use. Brass wear strips on the rubbing face, an extra pin for use as a marking gauge, and a brass knurled thumbscrew are all here. In addition, this tool features an inlaid brass head shield and a screw adjustment of the second pin for precise adjustment. This is truly a fine tool that will last a lifetime! Overall size is approximately 8"

605-1200 .... Screw-type Rosewood Gauge

**Small Levels**



These fine tools are based upon a traditional design having a full upper brass plate and lower brass tipped ends. The body of the level is made of the best quality rosewood. Made in England.

605-3506 ..... 6" Level

605-3512 ..... 9" Level

**Rosewood Try Square**

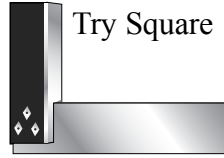

Made from the best quality rosewood and tempered steel blades, these squares have a brass face for protection against damage and wear. The blade is securely held by steel rivets with surrounding inlaid brass diamonds. Made in England.

605-2250 .....Rosewood 6" Try Square

605-2260 .....Rosewood 9" Try Square

605-2270 .....Rosewood 12" Try Square

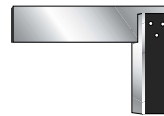

Miniature version try square is great for model work, or anywhere that a small square is needed. Round rivets hold the blade in place. Made in England.

605-4010 ..... 3"

**Rosewood Panel Gauge**

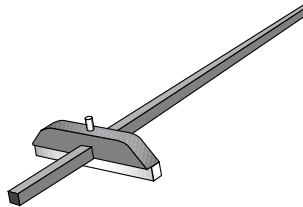

Thirty inch panel gauge is for those jobs where an ordinary marking gauge will just not do the trick. Not only is the stem long (at thirty inches), but the stock is longer as well (just under eight inches). Completely made of rosewood, the tool is locked in place by a plastic screw. The inner face is lined with brass to prevent wear. Perfect tool for marking out sheet goods. Made in England.

605-1300 ..... Rosewood Panel Gauge

**Wheel Marking Gauge**

*veritas*®



This marking gauge features a cutting wheel that solves many problems commonly associated with marking gauges. The sharp wheel cuts the grain of the wood cleanly, and the cutting edge is beveled in such a way that it forces the gauge face against the stock.

860-1400 ..... Wheel Marking Gauge

860-1405 ..... Spare Blade Only

**Sliding T-Bevels**

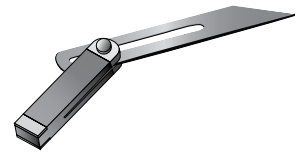

Adjustable to any angle, use this fine tool for marking or checking angles. The stock is made of rosewood with brass fittings, while the tempered steel blade is secured by a brass locking knob. Made in England.

605-3150 ..... 7 1/2"

605-3160 ..... 9"

605-3170 ..... 10 1/2"

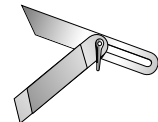

Miniature sliding bevel for model making, or other small size work. This tool locks with a thumbscrew. Made in England.

605-4060 ..... 4 1/2"

**Sliding T-Bevel**

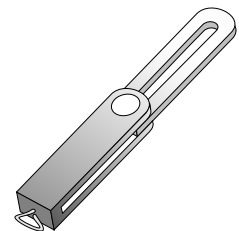

Sliding bevels are a must for every shop, and Shinwa bevels are finely made entirely of metal. Secure locking is achieved by means of an end tightening mechanism.

730-3008 ..... 8"

730-3010 ..... 10"

**Adjustable Bevel**



The sliding section of the adjustable bevel is 2 3/4" long and the base is 3 1/2" and 1/8" thick. Featuring a knurled lock and high quality construction, this handsome T-bevel is sized for convenience and a wide range of shop applications. Made in England by Richard Kell.

625-0500 ..... 4" Adjustable Bevel





### Bevel Gauge

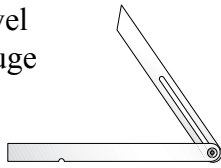

This all-metal bevel gauge is slim, sturdy and easy to use. A small notch is provided for releasing the blade from its storage slot. The blade is then locked at the desired location via a knurled knob. Available in two lengths and both easily fit in apron or pants pockets. Shinwa.

730-4500 ..... Bevel Gauge 150mm (6")  
730-4550 ..... Bevel Gauge 250mm (10")

### Transfer Bevel

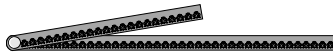

This nicely finished stainless steel bevel has a strong friction joint that allows easy setting yet holding strength to prevent movement. Blades are  $\frac{19}{32}$ " wide and  $\frac{5}{64}$ " thick. Leg lengths of about seven and eleven inches. Shinwa.

730-4000 ..... Transfer Bevel

### Angle Divider

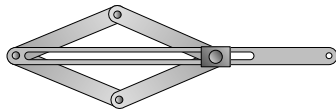

This tool makes it easy to divide an angle in half for accurate mitering as well as transferring angles from 10° to 170°. Makes finish carpentry significantly easier and faster. Commonly used angles are marked for ready reference.

800-2000 ..... Angle Divider

### Angle Master

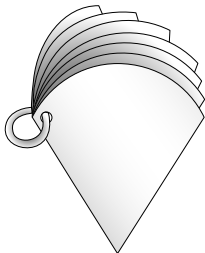

Never again worry about machine tool setup when preparing multisided pieces. These precisely made gauges give you the exact angle needed for seven of the most commonly used angles. Constructed of durable plastic for long life. Made in England by Richard Kell.

625-4000 ..... Angle Master

### Combination Square Set

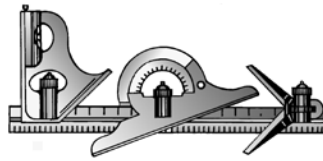

This combination set is great for the woodworker and includes a mitre square head, center head, and protractor head -- all on a 12" stainless steel blade marked in both inch and metric measurements. The square head has a built-in spirit level that is viewable from the top, bottom, and sides. A small scribe is also located in the square head. This scribe screws into the storage spot, so there is less chance of it being lost. The protractor head allows any angle between 0° and 180° to be worked. The centering head makes it easy to find the center of round work, making it ideal for turners. All heads are removable and adjustable.

630-4200 ..... Combination Square Set

### Small Combination Square

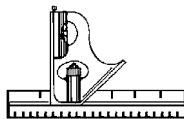

This finely made combination square can be just the tool for certain layout work. The blade is 6" long and made of aluminum. Unlike some smaller combination squares, the stock and blade of this quality tool are made to work together.

630-4110 ..... 6" Combination Square

### Combination Square

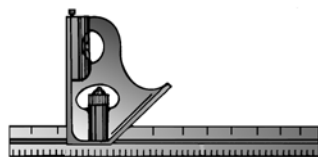

Heavy duty combination square. A cast iron stock distinguishes this square from others. Faces are ground for accuracy, and the head incorporates a high visibility vial, scribe, and brass adjusting screw. Blade is 12" long overall.

630-5000 ..... Combination Square

### Mitre Square

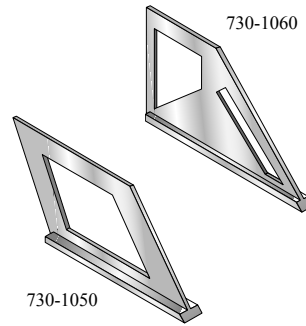

Finely made tools which are extremely useful for layout and machine setup. The mitre square checks 45 or 135 degree angles. The Combination square adds ninety degree capability and useful markings.

730-1050 ..... Mitre Only  
730-1060 ..... Combination Square

### Wrap-Around Mitre Square

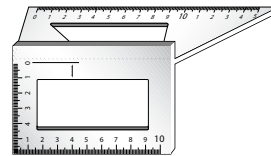

A clever layout tool comprised of two right angle elements attached to one another. One element shape is rectangular with a rectangular opening. The other element has 45° and a 90° shaped edges with a similar cut out. In this configuration, the mitre square is unique for doing layout work on two surfaces on a board. The outer edges have millimeter calibrations. The Wrap-Around Mitre Square is ideal for laying out mortise and tenons, picture frame corners, chair legs and a myriad of other applications. Shinwa.

730-1070 ..... Wrap-Around Mitre Square

### Dovetail Markers

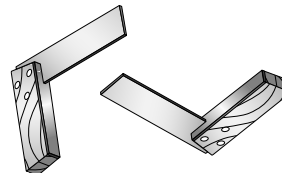

Two high quality tools made from the finest rosewood, brass, and tempered steel. One tool has a 1:6 ratio while the other 1:8. These are the most useful and traditional angles for handcut dovetails. Made in England.

605-4020 ..... Set of Two Dovetail Squares

### Engineer Square

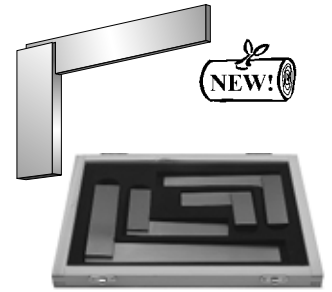

Engineer's try squares are workshop grade with hardened blade. Both blade and stock are ground for straightness and accuracy. All sizes are extremely useful for machine setup, and the smaller sizes can be helpful when working on miniature projects. Set contains squares 2" through 6" in a wooden box.

885-1002 ..... 2" | 885-1006 ..... 6"  
885-1003 ..... 3" | 885-1009 ..... 9"  
885-1004 ..... 4" | 885-1012 ..... 12"  
885-1500 ..... Set in Wooden Box

### Try/Setup Gauge

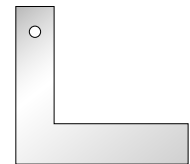

This solid brass tool lets you have a 90 degree angle available at all times (hole is for key chain). Overall tool size is  $2\frac{3}{8}$ " x  $1\frac{7}{8}$ ". Richard Kell.

625-3500 ..... Try/Setup Gauge

### Brass Dovetail Marker

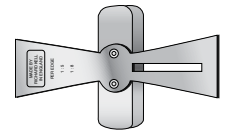

Double ended marker has 1:5 slope on one end for softwoods and 1:8 for hardwoods on the other. Deluxe model (illustrated) with right angle slot means there is no need to switch back & forth to a try square. Solid brass. Richard Kell.

625-2000 ..... Standard Model  
625-2050 ..... Deluxe Model

### Dovetail Markers



Handy aluminum markers can be flipped to mark both slopes of a dovetail. Color coded for convenience.

860-1045 ..... Set of two



**Folding Rules**



Folding rule, made from well seasoned hardwood with brass joints. Accurately machined with large markings. This is the same measuring device that has been used by generations of woodworkers and craftsmen. European made.

650-1167 .....Three Foot Folding Rule

**Steel Rules**

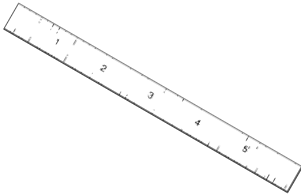

Rustless stainless steel ensures that these rules retain their finish. Permanent etched graduations show metric graduations of 0.5 mm, mm, cm. Imperial graduations of 1/16", 1/32", 1/64".

900-1040 .....6" w/Hanging Hole  
900-1060 .....12" w/Hanging Hole  
900-1080 .....24" w/Hanging Hole

**Center Rules**

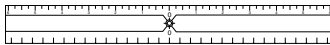

How many times have you struggled to find the center of your work? Those days are over with these easy to use center rules, graduated in 1/32" increments on top and 1/16" increments on the bottom.

825-5025 ..... Center Rule 12"  
825-5050 ..... Center Rule 24"

**Hooked Rules**



Steel rules in three lengths. All are marked in both metric and inches. The hook easily grabs the end of a board or it can be adjusted so that one side is hook-free and the other remains as a hook. The hook assembly can also be removed for standard scale type uses.

825-5150 .....6" Hooked Rule  
825-5175 ..... 12" Hooked Rule  
825-5200 ..... 18" Hooked Rule

**Self-Adhesive Rule**

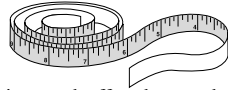

Save time and effort by not hunting for a bulky tape pocket measure by attaching this self-sticking 48" rule to workbenches or other work surfaces. Available for Left-to-Right or Right-to-Left applications.

825-6100 .....48" Left To Right  
825-6125 .....48" Right To Left



**Straightedges**



A straightedge can prove of great benefit in setting up machines such as planers and jointers, but you will find them useful for layout work as well. The twenty-four inch steel tool is ideal for machine set-up. It is 1 1/2" wide by 1/4" thick. Both edges are ground flat to within 0.001" over the length of the tool. The thirty-eight inch aluminum straightedge is 1 3/4" wide and 7/16" thick. The reference edge is machined flat to within 0.003" over the length. Both tools have hanging holes for easy storage.

860-9050 .....24" Steel  
860-9200 .....38" Aluminum

**Flexible Curve Rule**



Laying out and marking an irregular line can throw

any woodworker a "curve", but with this useful tool the job can be done simply and with accuracy. A lead core is surrounded by a vinyl body that includes a raised "inking" edge. This rule is twenty-four inches long, is infinitely adjustable, and will lay flat on your drawing board or workpiece.

730-3060 ..... Curve Rule

**Bevel Scale**



Tired of frustrating attempts at setting bevel gauge (T-bevel) angles to an exact angle? This very handy device makes it effortless to set angles. Simply place the Bevel Scale next to the bevel gauge and adjust to the well-marked angle of choice. Marked in quarter degrees from 0 to 50° it is 3" x 12". The reverse side features a centering scale in centimeters and a left reading-right reading scale. One end of the scale has a vertical height scale, ideal for height adjustments on table saw blades or router cutters. All markings are chemically etched and highly accurate. T-Bevel not included.

825-5300 ..... Bevel Scale

**Mite-R-Gage**

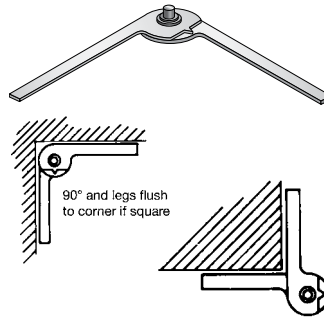

90° and legs flush to corner if square

Take the guess work out of angles. Fully rotational through 360 ° the Mite-R-Gage uses two legs that allows you to measure both inside and outside angles, transfer exact angles direct to stock, check corners for squareness or set alignment of arm or table saw. It can layout simple or compound miters. Overall length of each leg is 11 1/2". USA.

238-1000 ..... Mite-R-Gage

**Protractor Rulers**

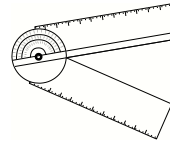

This handy tool is available in two sizes. The six inch protractor can be slipped into your pocket so that it is handy for instant use, while the twelve inch size is great for larger work. Use these tools to draw an angle, measure an angle, draw or measure lines, and to read angles off from existing work. Both rules feature a magnifier to better read the angle of the protractor.

825-6150 ..... Protractor/Ruler 6"  
825-6175 ..... Protractor/Ruler 12"

**Protractor**

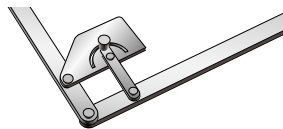

A multipurpose addition to your lay out tools. The built in protractor makes for accurate measuring and transferring of all angles. Also indispensable as a ruler and marking & cutting guide. This aluminum tool features extra length 20" and 9" arms, easy-to-read markings, and brass tightening screws.

800-2010 .....20" long

**True Angle**

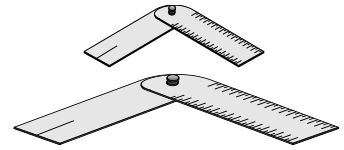

The True Angle™ is a superior measuring and layout tool that makes angles faster! Make and measure inside and outside corners with great accuracy. Available in four sizes to accommodate every variety of work. USA.

148-1106 ..... Pocket Size  
148-1112 ..... Folder Size  
148-1118 ..... Desk Size  
148-1123 ..... Shop Size

**Attachable Dial**



This is the perfect accessory for the True Angle marker. This four inch dial is quickly attached to any True Angle so that you can more easily read degrees directly and instantly. USA.

148-1104 ..... Attachable Dial - 4"

**Crown Molding Book**



Install crown molding and trim like a Pro! Easy to follow three step method is written for the novice do-it-yourselfer. Over 350 photographs with easy to understand instructions. Includes many tables and charts for faster work. Kit contains the book along with pocket and desk size True Angle tools.

148-2000 .. Crown Molding & Trim (Book)  
148-2025 ..... Kit with Book and Tools

**E-Z Angle**

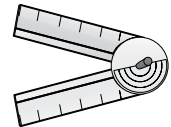

An adjustable protractor device that pivots 180 degrees. Each leg of the durable clear plastic tool is six inches long. The E-Z Angle can quickly and accurately measure the angle of any inside or outside corner.

299-1000 ..... E-Z Angle



### Brass Caliper

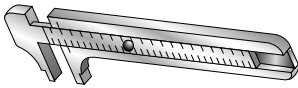

Solid brass caliper will quickly determine the thickness of material. Perfect tool to keep in your pocket or in your shop apron.

885-2050 ..... Caliper

### Brass Caliper

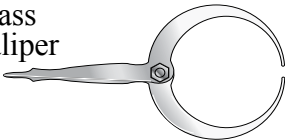

This beautiful double-ended caliper is 5" in overall length and has a high quality center point featuring very close tolerance parts. By rotating the two elements it can precisely measure either internal or external thicknesses. It is ideal for measuring wood thickness, such as the walls of turned bowls. Made in England by Richard Kell.

625-1000 ..... Double Ended Brass Caliper

### Thickness Gauge



Use for quick measuring of stock from 1/32" to 2" in 1/32" increments. Great for measuring the wall thickness of bowl and other turnings.

825-5100 ..... Thickness Gauge

### Trammel Heads

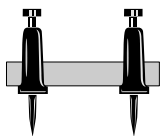

One pair of heads, when mounted on a beam 1/2" to 1 1/8" wide, provides an efficient and convenient means of laying out points, arcs, and circles. Can hold a pencil as well. Kunz

580-4100 ..... Trammel Heads

### Pantograph

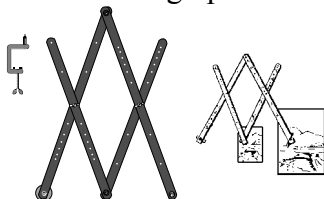

Enlarge or reduce your original art, plans, and projects, with this sturdy all metal device. Made in Japan.

730-1090 ..... Pantograph

rlc200906

### Compasses, Dividers and Calipers

These French made tools are all superb quality and will make measuring and layout work easier and more accurate. All tools are nicely polished with brass fittings where feasible. In addition, all feature a unique quick-nut adjustment that is easy and fast to use. This is a broad assortment of styles and sizes, with all being hand finished and tested as the last step in the production process. Size indicates the maximum capacity.

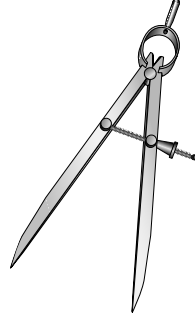

Dividers

850-1010 .....	100 mm
850-1015 .....	150 mm
850-1020 .....	200 mm

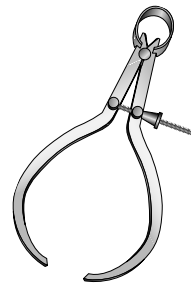

Outside Calipers

850-1210 .....	100 mm
850-1215 .....	150 mm
850-1220 .....	200 mm
850-1225 .....	250 mm

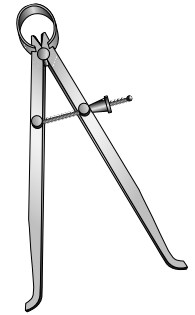

Inside Calipers

850-1100 .....	100 mm
850-1115 .....	150 mm
850-1120 .....	200 mm

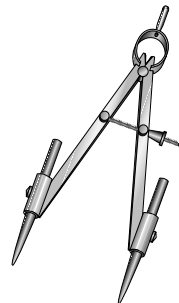

Compass with Carbide Points—B

850-2110 .....	100 mm
850-2115 .....	150 mm
850-2120 .....	200 mm

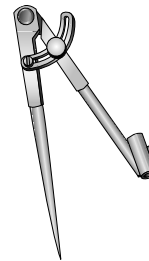

Compass with Quadrant—C

850-2316 .....	160 mm
850-2319 .....	190 mm
850-2322 .....	220 mm
850-2325 .....	250 mm
850-2331 .....	310 mm
850-2340 .....	400 mm

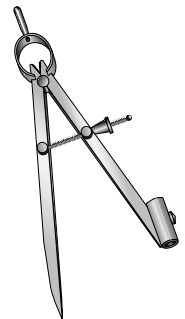

Compass—A

850-1310 .....	100 mm
850-1315 .....	150 mm
850-1320 .....	200 mm

### Oval & Circle Drawing Jig

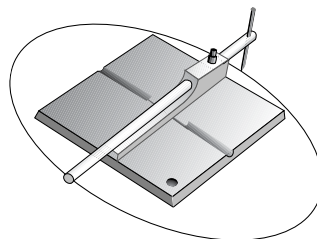

Woodworking is not always about square corners or mitre joints. Sometimes you need to layout a circle or an oval for that special project you are working on. This layout tool will draw circles from eight inches to twenty-four inches in diameter, as well as ovals from eleven inches to thirty inches (measured on the longer axis).

825-5250 ..... Oval/Circle Drawing Jig

### Yardstick Compass

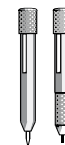

Set of trammel heads specially designed to fit a common yardstick. Comes with pencil lead which can be replaced with blade.

213-2100 .....	Compass
213-0246 .....	Blade

### Pounce Wheel

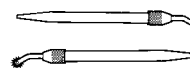

Transfer lines right through your full-size patterns. Simply make a full-size paper pattern and run the pounce wheel over the pattern. The fine teeth of this tool will ever so slightly mark the wood exactly. You can also place a piece of carbon paper under the paper pattern.

213-1009 .....	21 teeth/inch
213-1012 .....	15 teeth/inch

### Center Finder

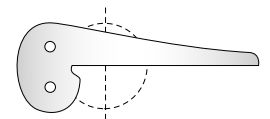

This tool makes finding the center of 3/4" to 8 1/2" stock a pleasure as well as a breeze. Made in England, of solid brass, by Richard Kell.

625-2500 ..... Center Finder

### Center Finder

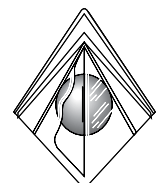

Finds exact center in seconds with no calculations. Gives center of round, square, hexagon and octagon stock for turning in a lathe or other purposes. Maximum 8" circle and octagon; 8" square; 5 3/4" hexagon.

800-2875 ..... Center Finder





**Awls**

Here is a selection of awls from Germany and Japan that can be used for a wide variety of shop tasks. Mark the point where you will start a drill, mark a line against a rule, pierce a small hole in thin material.



730-2000 ... 3" Blade... 5 1/2" OA..... Japan



520-1060 ... 4 1/4" Blade... 7 1/2" OA Germany

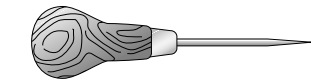

520-1050 ... 2" Blade ..... 4 7/8" OA Germany

**Awl**

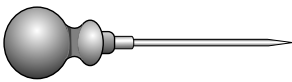

With a round ball handle that perfectly fits in the hand, and a long five inch tapered blade, this awl is extraordinarily useful for a wide variety of marking purposes. Made in England.

620-1200 ..... 5" Blade..... 7 1/4" OA

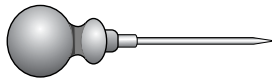

Similar to the awl above, but with a 2 1/2" blade and a bubinga wood handle. Made in England.

620-1250 ..... 2 1/2" Blade

**Hock Marking Knife**



This right-hand or left-hand, spear point marking knife (the bevels are on one side only) is perfect for scribing fine lines against a straight edge. Overall size is 1/2" x 1/4" x 7".

110-8575 ..... Marking Knife by Ron Hock

**Rosewood Marking Knife**



Made with a carbon steel blade and rosewood handle, this often overlooked little item is essential for accurate marking out. Overall length is 6 1/2" with the blade measuring 3/4" by 2 1/4". Made in England.

605-5000 ..... Rosewood Marking Knife

**Contour Gauge**

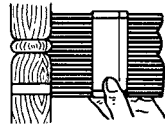

Quickly copies and holds irregular shapes when the steel teeth are pressed against the work. The outline can then be transferred by marking along teeth. Extremely helpful in cutting floor coverings to fit, coping work, and other jobs where work is cut to fit. Two six inch gauges can be joined together. Made in Japan.

799-1000 ..... 6" Contour Gauge  
799-2000 ..... 12" Contour Gauge

**Contour Gauge**

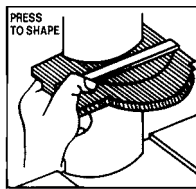

Professional contour gauge with plastic pins is ideal for joinery work, fitting tiles, carpets, linoleum, etc. Two gauges can be combined for a longer length if necessary.

800-2510 ..... 5"  
800-2520 ..... 10"

**Square Fence**



A clever and handy accessory for the standard carpenter's square. By attaching the fence to a square it quickly and accurately aligns the square to the workpiece edge. Secured by two brass screws, the 8" anodized aluminum extrusion fence can also be used as a handle. Works on straight and round-edge materials.

860-5510 ..... Square Fence

**Saddle Square**



Nifty square for transferring a layout line from one perpendicular surface to another. Allows the easy location of one surface line on to the corresponding perpendicular surface.

860-5520 ..... Saddle Square

**Indelible Pencils**



These pencils will leave a mark or line longer than others - and require very little pressure in use.

860-4040 ..... Package of Ten Pencils

**Carpenter's Helper**

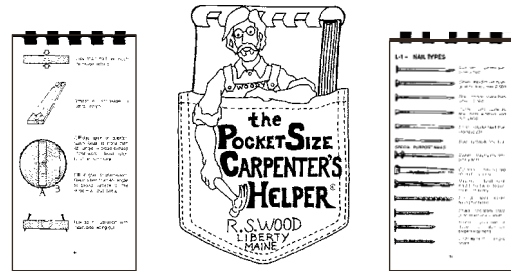

Compact, comprehensive reference handbook goes to work with you. Just 3 1/4" x 5 1/4", its 104 pages are crammed full of information. The Boston Sunday Globe said, "The information is voluminous and clear. The illustrations are also clear and simple. The section on wood is a gem . . . It's all there."

455-1000 ..... Carpenter's Helper



**Carpenter Pencil**



Some craftsmen might say that there is no difference in one carpenter's pencil to another -- until the day they start to use this fantastic German marking tool.

524-7000 ..... Carpenter Pencil

**Spring Punch**



Centering/transfer spring punch. Excellent to center mark a hole from one piece to another, as in hinge placement, or jig making or machine set up. Large conical spring mounted head centers automatically on holes of most diameters. A light hammer blow drives the Chrome Vanadium fine point, leaving centered mark on work. Overall length 110mm, working length 30mm. Made in France.

848-1550 ..... Centering/Transfer Punch

**Automatic Center Punch**



This very nice spring loaded automatic punch can easily double as scribe. Has knurled steel body with central portion in soft rubber coating, so as to be easy on the hand. Unscrewing or screwing top adjusts the strike force. Fine Chrome Vanadium point gives, good use on metals, and on wood. Very strong force for its modest weight. With pencil clip. Made in France.

848-1600 ..... Automatic Center Punch

**Plumb Partner**

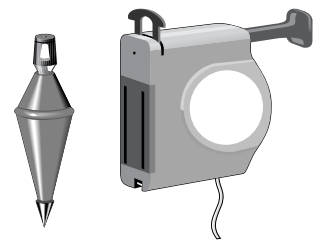

The plumb partner will soon become your valued assistant. Secure the plumb partner to nearly any surface by using the retractable metal hook, the built-in pin that is easily driven into wood with the push of your palm, or with the strong magnet. Normally the plumb partner will position the plumb line about two inches from the surface, but a small hook in the front of the tool allows you to have the plumb line hug the wall. Works with any plumb 100 to 850 grams in weight. The five meters long string is easily replaced. Made in Japan.

730-5000 ..... Plumb Partner  
730-5005 ..... Pin Only For Plumb Partner

**Quick Stop Plumb Bob**



This is a significant development in the traditional plumb bob. The special quick stop mechanism should dampen the swing in only six seconds, speeding up your work with no extra effort on your part! Made in Japan.

730-5110 ..... Plumb Bob 150 Grams

Discontinued





DRILLING & BORING



In 1919 Michael Strasek introduced the trademark "Stern". In 1958 carbide tools were introduced into the production of the company. In 1966 a second plant was established with the most up-to-date equipment. In 1975 numerical control was introduced, and exports were shipped to over 45 countries. 1999 saw this fine Austrian company's 80th Anniversary.

Universal Bits

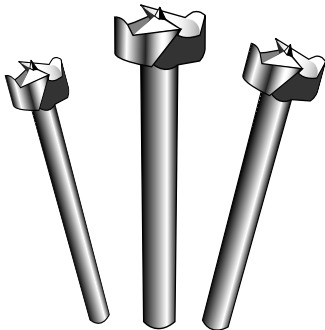

Makes a smooth, flat bottomed hole like a forstner bit, but with a really important difference. These bits are machine sharpenable! No more hand sharpening. These bits are top quality, high carbon steel.

570-3504	.....	1/4"
570-3506	.....	3/8"
570-3508	.....	1/2"
570-3510	.....	5/8"
570-3512	.....	3/4"
570-3514	.....	7/8"
570-3516	.....	1"
570-3518	.....	1 1/8"
570-3520	.....	1 1/4"
570-3522	.....	1 1/2"
570-3524	.....	1 3/4"
570-3526	.....	1 7/8"
570-3528	.....	1 3/4"
570-3530	.....	1 7/8"
570-3532	.....	2"
570-3534	.....	2 1/8"

Adjustable Universal Bit

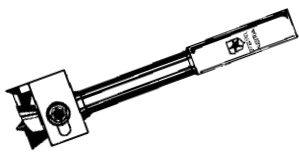

A fine quality tool that does a good job of producing those intermediate diameter holes not possible with standard size drills. Design is configured like a universal bit to give the cleanest hole possible from this type drill. Available in two size ranges and in either high carbon special steel, or industrial grade carbide tipped.

Diameter	Length	Cutters
570-5700	.....22-50mm	.....140mm ..... Steel
570-5750	.....22-50mm	.....140mm ..... Carbide
570-5800	.....34-80mm	.....150mm ..... Steel
570-5850	.....34-80mm	.....150mm ..... Carbide

Forstner Bits

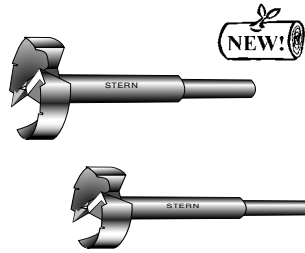

Drawing upon years of experience in making the highest quality forstner bits available, the Stern bit has been re-designed to include a tooth-like pattern on the outside rim of the tool. These teeth assist in the cutting action, and yet still offer the same advantages of the traditional forstner bit. These bits are guided by their circular rim instead of their center, and consequently will bore any arc of a circle and can be guided in any direction regardless of grain or knots. Bores a flat bottom hole. Set of five sizes indicated by \*, set of eight sizes by +.

570-3005	.....	1/4"	570-3019	.....	1 3/16"
570-3006	.....	*+ 3/8"	570-3020	.....	*+ 1/2"
570-3007	.....	7/16"	570-3021	.....	1 3/16"
570-3008	.....	*+ 1/2"	570-3022	.....	1 1/8"
570-3009	.....	9/16"	570-3023	.....	1 7/16"
570-3010	.....	+ 3/8"	570-3024	.....	+ 1/2"
570-3011	.....	1 1/16"	570-3025	.....	1 9/16"
570-3012	.....	*+ 3/4"	570-3026	.....	1 1/8"
570-3013	.....	1 3/16"	570-3027	.....	1 11/16"
570-3014	.....	+ 7/8"	570-3028	.....	1 3/4"
570-3015	.....	1 5/16"	570-3029	.....	1 13/16"
570-3016	.....	*+ 1"	570-3030	.....	1 7/8"
570-3017	.....	1 1/16"	570-3031	.....	1 15/16"
570-3018	.....	1 1/8"	570-3032	.....	2"

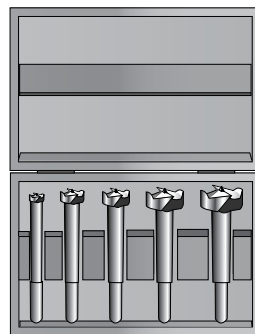

Set of 5 Forstner Bits includes sizes 3/8", 1/2", 3/4", 1", 1 1/4".

570-3100 .....Set of 5

Set of 8 Forstner Bits includes sizes 3/8", 1/2", 5/8", 3/4", 7/8", 1", 1 1/4", 1 1/2".

570-3150 .....Set of 8

Metric Forstner Bits

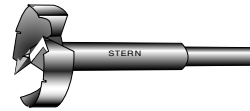

Made to the same very high quality as our inch size forstner bits. Because they are rim guided you can bore any arc of a circle. With the increasing popularity of European hardware these metric sizes are becoming very important. Overall length of 90mm.

570-5100	.....	10mm
570-5110	.....	11mm
570-5120	.....	12mm
570-5130	.....	13mm
570-5140	.....	14mm
570-5150	.....	15mm
570-5160	.....	16mm
570-5170	.....	17mm
570-5180	.....	18mm
570-5200	.....	20mm
570-5220	.....	22mm
570-5240	.....	24mm
570-5250	.....	25mm
570-5260	.....	26mm
570-5278	.....	27.8mm
570-5280	.....	28mm
570-5300	.....	30mm
570-5320	.....	32mm
570-5340	.....	34mm
570-5350	.....	35mm
570-5360	.....	36mm
570-5380	.....	38mm
570-5400	.....	40mm
570-5420	.....	42mm
570-5440	.....	44mm
570-5450	.....	45mm
570-5460	.....	46mm
570-5480	.....	48mm
570-5500	.....	50mm

Clockmakers Bit



Three inch bit for installing clockworks. This bit has a 1/2" shank and is 5 1/2" overall length. For drill press only. Maximum speed of 400 RPM for softwoods and 300 RPM for hardwoods.

570-6000 .....Clockmaker's Bit

Carbide Tipped Bits

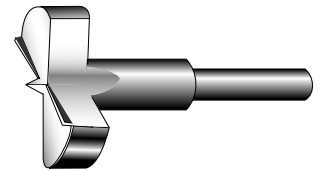

Drilling tools with carbide tipped cutting edges. Several sizes (especially 35mm) are essential for mounting adjustable hidden hinges. Overall length of 60mm.

570-2020	.....	20mm
570-2022	.....	22mm
570-2024	.....	24mm
570-2025	.....	25mm
570-2026	.....	26mm
570-2028	.....	28mm
570-2030	.....	30mm
570-2032	.....	32mm
570-2034	.....	34mm
570-2035	.....	35mm
570-2040	.....	40mm

Forstner Bit Extension

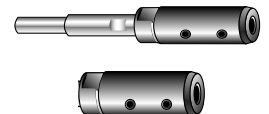

Three piece extension set for our already very useful forstner bits. Fits inch size forstners and multi-spur bits found in this catalog. Adds about 3 1/2" to drill.

570-3004 .... Extension for 5/16" & 3/8" Hanks

Countersink



Yes, this looks different than the countersinks that you are used to, but the results are much better! This tool shears the wood rather than scraping the wood, and the results will make you wish that you had found this tool sooner. Wood Magazine calls this "The best countersink bits I've ever seen". Stern - Austria.

570-9216	.....	Up to 16mm holes
570-9220	.....	Up to 20mm holes



DRILLING & BORING

Metric Brad Point Drills  
High Speed Steel

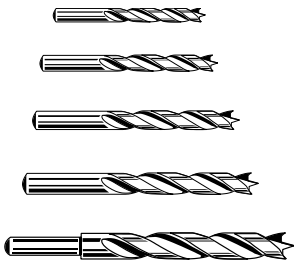

Excellent quality High Speed Steel woodworking bits. These have straight shanks to 10mm. Sizes larger than 10mm have 10mm shanks. Stern - Austria.

	Diameter	Length
570-7020	.2mm	48mm
570-7030	.3mm	70mm
570-7040	.4mm	80mm
570-7050	.5mm	90mm
570-7060	.6mm	100mm
570-7067	.6.75mm	110mm
570-7070	.7mm	110mm
570-7075	.7.5mm	115mm
570-7080	.8mm	115mm
570-7090	.9mm	125mm
570-7100	.10mm	130mm
570-7110	.11mm	140mm
570-7120	.12mm	140mm
570-7130	.13mm	140mm
570-7140	.14mm	140mm
570-7150	.15mm	140mm

Plug & Tenon Mill



If you are cutting plugs on a daily basis -- lots of plugs -- then this tool is the answer to your question, "Why doesn't someone make a great plug cutter?". Super heavy duty, suitable for making very long plugs or cutting round tenons. Made in Austria by Stern.

570-8006	.3/8"
570-8008	.1/2"
570-8012	.3/4"
570-8014	.7/8"
570-8016	1"
570-8020	1 1/4"
570-8022	1 3/8"

Tube Type Plug Cutter



This tool is designed to eject a plug up to one inch long. Easy cutting and well made tool, this can speed up production of plugs significantly. Made in Austria by Stern.

570-8506	.3/8"
570-8508	.1/2"
570-8512	.3/4"
570-8514	.7/8"
570-8516	1"
570-8520	1 1/4"
570-8522	1 3/8"

TwinLand  
Brad Point Drills

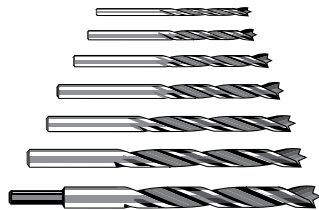

Available as a set or individually, these brad point drills feature the new TwinLand design for better drill hole guidance and smoother holes. Drills are produced out of alloy tool steel and have double lands between each flute. This TwinLand concept improves accuracy, as the second land surface guarantees improved guidance when hand drilling even with minimal depth. This second land surface also prevents chips squeezing between the drill and hole wall - eliminating burns and marks. The drill points are a traditional brad point which are ground with diamond wheels. Flute are a black finish. The two larger sizes have 3/16" shanks. Made in Germany.

525-4150	Set/7
525-4004	1/8"
525-4006	3/16"
525-4008	1/4"
525-4010	5/16"
525-4012	3/8"
525-4014	7/16"
525-4016	1/2"

Long Brad Point Drill



Exceptional bits designed for deeper holes or for clearing workpiece obstructions. Made of alloy tool steel, they have a single machine-milled flute, sharp center point and spur cutting edges. Drill points are ground with CBN diamond wheels. All are ten inches in overall length. Germany.

525-3510	1/4"
525-3520	5/16"
525-3530	3/8"
525-3540	3/8" Shank
525-3550	3/8" Shank
525-3560	3/8" Shank

Inches to Millimeters

Inch	Millimeters
1/32	0.8
1/16	1.6
1/8	3.2
3/16	4.8
1/4	6.4
5/16	7.9
3/8	9.5
7/16	11.1
1/2	12.7

Clean Exit Drill Bit



COLT



This clean exiting drill bit from Colt in Germany has precision cutting characteristics and a newly developed cutting point that nearly guarantees a clean hole without breakage and chipping after drilling in and out of your work. For the first time no support at the back, or any other attachment, is needed for drilling a clean hole on both sides. This new tip (patent pending) accomplishes this better than all existing known types of drill bits. Made of HSS-M2 with fully ground flutes, two lands between flutes, and the new cutting tip. Tested by professionals who confirm that no backing board is required for drilling a clean, tear-free hole. This bit speeds up your work with no loss of quality and is perfect for cabinetmakers. Especially suitable for drilling of particle boards, coated particle boards, MDF material, plastics, hard and soft wood. Works best in a drill press or other stationary machine. Speed range should be 1400 to 3500 rpm depending upon the material being drilled and the drill diameter.



Metric Drills

525-2510	4mm
525-2520	5mm
525-2530	6mm
525-2540	7mm
525-2550	8mm
525-2560	9mm
525-2570	10mm
525-2580	8mm shank
525-2590	8mm shank
525-2600	8mm shank
525-2610	10mm shank



Inch Drills

525-3020	1/8"
525-3030	3/16"
525-3050	1/4"
525-3070	5/16"
525-3090	3/8"
525-3100	8mm shank
525-3110	8mm shank
525-3200	Set of Seven in Wood Box

Self-Centering  
Drill Bits

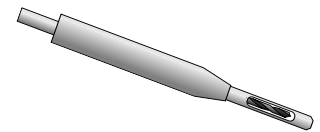
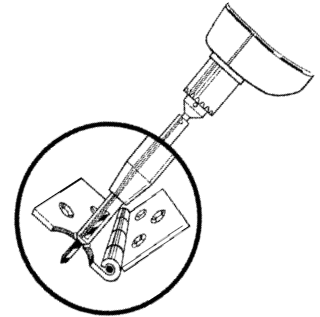

Speedy, accurate drilling tool with self-centering abilities. Saves hours of time drilling holes for hinges, striker plates—all hardware using screws. Save even more time with hex shank bits for screwguns. Denim case conveniently holds bits 305-0995, 1000, 1005. Made in the USA.

Bit #	Fits screw size
305-0995	#3
305-1000	#5
305-1070	#7
305-1005	#9
305-1010	#12
305-1015	#14
305-3003	#3 Hex Shank
305-3005	#5 Hex Shank
305-3009	#9 Hex Shank
305-2050	Vix Bit 5mm
305-2100	Vix Bit 1/4"

Replacement Parts = 305-xxxx

#	Guide	Drill	Spring	Washers	Set
3	0997	0996	0998	1004	0100
5	1002	1001	0998	1004	0100
7	1072	1071	1008	1009	0100
9	1007	1006	1008	1009	0100
12	1012	1011	1013	1014	0105
14	1017	1016	1013	1014	0105
5 mm	---	2055	---	---	---
1/4"	---	2105	---	---	---
170-2450	---	---	---	---	3 Pocket Denim Case

Millimeters to Inches

Millimeters	Inches
1	0.039
2	0.078
3	0.118
4	0.157
5	0.196
6	0.236
7	0.275
8	0.314
9	0.353
10	0.393
20	0.787
30	1.181
40	1.574
50	1.968
60	2.362



DRILLING & BORING

Hex Shank Countersinks

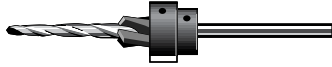

Each countersink combination has a HSS tapered drill bit, countersink and stop collar. In one drilling application the tapered bit and the countersink will create the correct pilot hole for a wood screw. The hex drive allows for a secure grip in drill chucks. Select the bit size to match drilling needs. Generally, it is helpful to have more than one size in order to match different screw sizes.

357-4050	.....#5 with Hex Shank
357-4060	.....#6 with Hex Shank
357-4070	.....#7 with Hex Shank
357-4080	.....#8 with Hex Shank
357-4090	.....#9 with Hex Shank
357-4100	.....#10 with Hex Shank

Plug Cutters

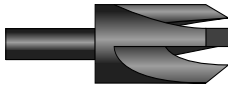

Plug cutters are the only cutting tool which allows you to make wood plugs to fill-in drilled holes. Ideally, use the same wood as the project to make plugs, the holes will almost disappear when filled with matching plugs. See chart on this page for the plug cutters that match the counterbore of the countersinks above.

357-3060	..... 3/8" with Hex Shank
357-3080	..... 1/2" with Hex Shank

Stop Collars



Use these stop collars on the countersinks above. Stop collars provides the operator control over how deep to drill. The collar is easy to use, simply slide it on the countersink and tighten with a hex wrench.

357-7060	..... 3/8"
357-7080	..... 1/2"

Replacement Taper Drills



Tapered to match screws sizes and perfect for drilling sized pilot holes which maximize thread grip along the full length of the screw. For use with the Fuller TPS adapter that comes with the countersinks above.

357-5050	..... HSS Taper Drill Only 1/8" (#5)
357-5060	..... HSS Taper Drill Only 9/64" (#6)
357-5070	..... HSS Taper Drill Only 5/32" (#7)
357-5080	..... HSS Taper Drill Only 11/64" (#8)
357-5090	..... HSS Taper Drill Only 3/16" (#9)
357-5100	..... HSS Taper Drill Only 13/64" (#10)

All of the items in the column above come in point-of-purchase packaging.

Countersink Drills



Drills the hole for the threaded and shank portion of wood screw, countersink for bevel under head, and if required, counterbore for wood plug. Complete with countersink, taper drill, & stop collar. All parts available separately. Size indicates wood screw sizing. Made in USA. Replacement parts are shown on this page.

Cs Complete	Screw Size	Cs
355-4030	.....3	1/4"
355-4040	.....4	3/16"
355-4050	.....5	3/8"
355-4060	.....6	3/8"
355-4070	.....7	7/8"
355-4080	.....8	3/8"
355-4090	.....9	3/8"
355-4100	.....10	7/16"
355-4120	.....12	1/2"
355-4140	.....14	1/2"
355-4160	.....16	5/8"
355-4180	.....18	5/8"

Countersink & Drill Sets

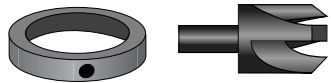

Set containing sizes 5 to 12 countersinks, drills, and stop collars comes in a special wooden block.

355-4000	..... Set/7
Contains four drills, four countersinks, one each stop collar and plug cutter.	

355-4010	..... #5 Set
Contains five countersinks, five taper drills and two each plug cutters and stop collars in hardwood case.	

355-4015	..... #8 Set
----------	--------------

Countersink Stop Collars

355-7040	..... 1/4"
355-7050	..... 5/16"
355-7060	..... 3/8"
355-7070	..... 7/16"
355-7080	..... 1/2"
355-7100	..... 5/8"

Countersink Drill Parts



Taper drills are available in regular length or long length. The countersinks do not come with stop collars, which are found elsewhere on this page. Made in USA.

Regular Length	
Item	Fits Countersink
355-5030	.....3
355-5040	.....4
355-5050	.....5
355-5060	.....6
355-5070	.....7
355-5080	.....8
355-5090	.....9
355-5100	.....10
355-5120	.....12
355-5140	.....14
355-5160	.....16
355-5180	.....18
355-5190	.....24
355-5200	..... 7/16" Drill

Long Length	
Item	Fits Countersink
355-5035	.....3
355-5045	.....4
355-5055	.....5
355-5065	.....6
355-5075	.....7
355-5085	.....8
355-5095	.....9
355-5105	.....10
355-5125	.....12
355-5145	.....14
355-5165	.....16
355-5185	.....18

Countersink Only		
Countersink	Screw Size	Plug Only
355-6030	.....3	.....1/4"
355-6040	.....4	.....3/16"
355-6050	.....5	.....3/8"
355-6060	.....6	.....3/8"
355-6070	.....7	.....3/8"
355-6080	.....8	.....3/8"
355-6090	.....9	.....3/8"
355-6100	.....10	.....7/16"
355-6120	.....12	.....1/2"
355-6140	.....14	.....1/2"
355-6160	.....16	.....5/8"
355-6180	.....18	.....5/8"
355-4991	.....	..... Set Screw
355-4992	.....	..... Allen Wrench

Plug Cutters

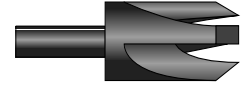

Designed for clean cutting and hardened for long life. Tool cuts fast and makes a smooth chamfered plug for easy starting in counterbored hole. USA.

355-3040	..... 1/4"	355-3120	..... 3/4"
355-3050	..... 3/16"	355-3140	..... 7/8"
355-3060	..... 3/8"	355-3160	..... 1"
355-3070	..... 7/16"	355-3180	..... 1 1/8"
355-3080	..... 1/2"	355-3200	..... 1 1/4"
355-3090	..... 5/16"	355-3220	..... 1 3/8"
355-3100	..... 3/8"	355-3240	..... 1 1/2"

"Snug-Plugs"



These plug cutters cut a slightly tapered plug so that you can always get a good fit between the plug and the hole. Sides of the plugs will be smoother, due to the shaving cut that these cutters produce. Lastly, plugs will have a chamfered end for easy insertion! (Veritas)

860-3104*	..... 1/4"	860-3105	..... 3/16"
860-3106*	..... 3/8"	860-3107	..... 7/16"
860-3108*	..... 1/2"		
860-3100	..... Set/3 Inch marked * above		

Drill Stop Collars



These collars are precision machined from solid bar stock, cold-rolled steel, and are balanced carefully. Set contains five collars 1/4" to 1/2" by 16ths of an inch. Made in USA.

355-7205	..... Set/5
355-7040	..... 1/4"
355-7050	..... 5/16"
355-7060	..... 3/8"
355-7070	..... 7/16"
355-7080	..... 1/2"
355-7100	..... 5/8"
355-7120	..... 3/4"
355-7140	..... 7/8"
355-7160	..... 1"

Countersink Sizing Table

Size	Setscrew	Counterbore Diameter	Counterbore OL	Drill Size
3	..... 1/8"	..... 1/4"	..... 3/16"	..... 3/32"
4	..... 3/16"	..... 5/16"	..... 7/8"	..... 7/64"
5	..... 3/16"	..... 3/8"	..... 7/8"	..... 1/8"
6	..... 3/16"	..... 3/8"	..... 7/8"	..... 9/64"
7	..... 3/16"	..... 3/8"	..... 7/8"	..... 5/32"
8	..... 3/16"	..... 3/8"	..... 7/8"	..... 11/64"
9	..... 3/16"	..... 3/8"	..... 7/8"	..... 1/4"
10	..... 1/2"	..... 7/8"	..... 7/8"	..... 13/64"
12	..... 1/2"	..... 1 1/2"	..... 7/8"	..... 7/32"
14	..... 1/2"	..... 1 1/2"	..... 7/8"	..... 1/2"
16	..... 5/16"	..... 5/8"	..... 1 1/16"	..... 9/32"
18	..... 5/16"	..... 5/8"	..... 1 1/16"	..... 5/16"



DRILLING & BORING

Gimlets



No need to find an electrical outlet! These high quality tools are hardened to the end of the flute, and the screw thread is specially annealed to make sure that it is not easily broken. The double spiral flutes are machined, rather than twisted, and will quickly and easily allow wood chips to clear the hole. Keep a set in the house, in the kitchen, and with your garden tools. An inexpensive, traditional, and extremely useful tool! Made in France.

- 849-3099 .....Set of Four Gimlets
- 849-3050 ..... 3mm
- 849-3060 ..... 4mm
- 849-3070 ..... 5mm
- 849-3080 ..... 6mm

Spiral Ratchet Screwdriver



For generations of woodworkers the spiral ratchet screwdriver was a must have tool. This screwdriver will drive and remove screws quickly and is as useful today as it was when it was first introduced. The spiral ratchet mechanism can be set to clockwise or counter-clockwise rotation, and even locked in place for extra turning power. These two models accept standard 1/4" insert bits so that you can work with any type of fastener. Made in Germany.

- 538-1335 ..... 335mm Screwdriver
- 538-1480 ..... 480mm Screwdriver



Also available are phillips replacement bits -- special alloy for long life. Length of 50mm (about 2") is perfect for the ratchet screwdrivers.

- 538-2131 .....#1
- 538-2132 .....#2
- 538-2133 .....#3

Hand Drills

Hand drills offer more than just slower RPMs. They provide control, safety and management of woods prone to splintering. These are quality hand drills meant for real work and for everyone, from students to seasoned craftsmen.



This 1/4" drill has a quality three-jaw chuck, smooth gears and a comfortable wood handle. Overall length is 9 1/4". Made in Germany.

- 538-3010 ..... 1/4" Capacity



Similar to 538-3010, this 5/16" sturdy drill offers a thick casting and smooth running single pinion gearing. Overall length is 11". Made in Germany.

- 538-3030 ..... 5/16" Capacity

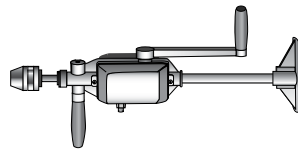

This Heavy-Duty 3/8" hand drill features a three-jaw chuck, chest plate, metal casing around the gears, polished finish and two speeds. The crank and side handles are wood. Overall length is 13 1/2". Made in Germany.

- 538-3050 ..... Breast Drill 3/8" Capacity

Hand Countersink



Handy and quick, this beautifully made countersink is a tool every woodworker should have. Easy to control and very high-quality with seven flutes for exceptionally smooth countersink boring. Overall length of 150mm, with wooden handle. Stern - Austria.

- 570-6100 ..... 16mm

Brace



This is an extremely high quality brace with a three jaw chuck that will securely grip round shank drills and hex shank tools. When using a traditional auger bit, the end of the bit sits in a square hole in the bottom of the chuck -- that bit is not going to spin for any reason. Ratchet mechanism allows the brace to work in confined spaces with ease. Many woodworkers find that this old-fashioned tool is not something easily replaced in this modern world! Made in France.

- 838-4000 ..... 10" Brace - Three Jaws

Jennings Pattern Auger Bits



These are the highest quality auger bits available -- and live up to those made a generation and more ago. These bits are well balanced with a fast clearing action preferred by furniture makers and craftsmen. The bits are eight to ten inches in overall length. Two cutting spurs cut the fibers of the wood as the screw thread tip pulls the bit through the wood. Made in England.

- 635-7904 ..... 1/4"
- 635-7906 ..... 3/8"
- 635-7908 ..... 1/2"
- 635-7910 ..... 5/8"
- 635-7912 ..... 3/4"
- 635-7914 ..... 7/8"
- 635-7916 ..... 1"
- 635-7918 ..... 1 1/8"
- 635-7920 ..... 1 1/4"

Screwdrivers for Brace

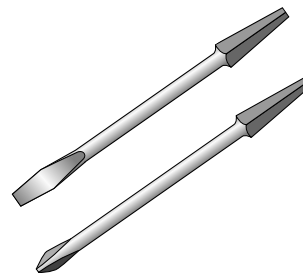

These screwdriver bits give incredible turning power when used in a bit brace. Selection includes the most common sizes for slotted and phillips screws.

- 875-1506 ..... 6mm Blade Width
- 875-1508 ..... 8mm Blade Width
- 875-1510 ..... 10mm Blade Width
- 875-1612 ..... Phillips #1-#2
- 875-1634 ..... Phillips #3-#4

Drill Gauge

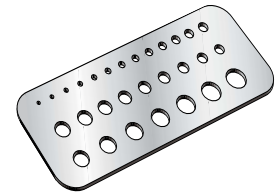

Gauge provides a quick and easy way to check the size of drills and other small round material. High quality steel with chrome finish.

- 885-2075 ..... Drill Gauge

Drill and Dowel Gauge

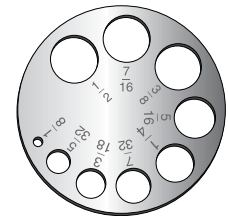

Made of solid brass, this tool should be accurate enough for anyone. (Tip: place over plugs before cutting off with a veneer saw, then chisel remainder.) Accurate to +/- .001" and made in England by Richard Kell.

- 625-4500 ..... Drill & Dowel Gauge

Depth Stops

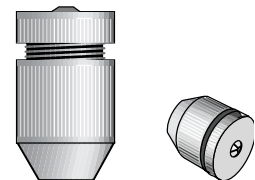

All you do is pick the correct stop for your bit, then adjust it to the desired depth of hole. Non-marring plastic for use with nearly all type bits. Set of two covers bits 1/16" through 1/2".

- 800-2300 ..... Set of 2

Dowel Former



Using this tool with regular dowel rod to make tight and precise fitting dowel pins in 1/4", 3/16", 3/8", and 1/2" sizes. Flutes produced in the wood are compressed, not cut, and will expand when glued in place for an exceptional fit.

- 800-3000 ..... Dowel Former





DRILLING & BORING

Deluxe Drilling Jig

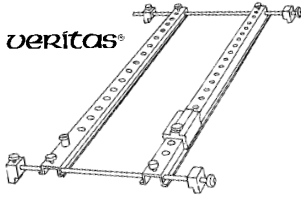

This drilling jig eliminates the time-consuming layout work usually associated with installing shelf supports. Rather than marking the location of every hole before drilling, you set the jig's rails at the desired inset from the edge, fix them in position with the thumbscrews on the clamp rods, and then drill. The jig guarantees that the holes will be exactly opposite each other and at equally spaced intervals. Twin-register pins positioned in the rails fit into the holes you have already drilled, ensuring that the holes will continue to be accurately spaced. An entire upright can be accurately chain drilled with no chance of error and no need for detailed measuring. The register pins have tapered tips and fit snugly into any hole from 3/16" to 3/8" (5mm to 10mm). The 24" rails each have 20 holes drilled at 1" intervals. Ample space

for chip clearance is provided to allow for easy withdrawal of your bit and to prevent jamming or burning. You are assured of holes drilled at exactly 90° because the hardened bushings are 13/16" long (substantially longer than others available). Ten standard hole sizes can be drilled with the included bushings (sizes 5, 6, 6.75, 7, 7.5, 8 (5/16") and 9mm, 7/32", 1/4" and 3/8"). A soft (unhardened) bushing (you drill to size) for custom application is also included.

The jig comes with regular-length clamp rods for use with material 12" wide or narrower. Long rods are available for material up to 24" wide, and extra-long rods for work up to 36" wide. A 7mm sleeve-setting punch is included.

860-7000 ..... Deluxe Drilling Jig

Replacement & Optional Equipment

860-7008 .....	5mm Bushing Only
860-7009 .....	6mm Bushing Only
860-7010 .....	7/32" Bushing Only
860-7011 .....	6.75mm Bushing Only
860-7012 .....	7mm Bushing Only
860-7013 .....	7.5mm Bushing Only
860-7015 .....	8mm Bushing Only
860-7017 .....	9mm Bushing Only
860-7016 .....	10mm Bushing Only
860-7020 .....	3/4" Bushing Only
860-7021 .....	3/8" Bushing Only
860-7025 .....	3/2" Soft Bushing Only
860-7100 .....	25" Optional Rods
860-7110 .....	37.5" Optional Rods

Double Pocket-Hole Jigs

Both styles make it convenient to drill two pocket holes with only one positioning of the jig. Perfect for face frames, cabinet doors, etc.

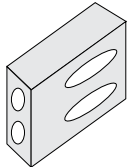

Non-adjustable holes on 3/4" centers. 800-2210 ..... Nonadjustable Jig

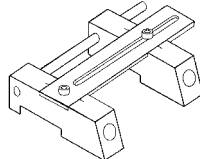

Adjustable from 3/4" to 3" centers. 800-2220 ..... Adjustable Jig

Drill Bushings

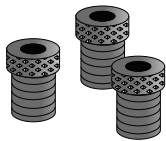

Use these bushings to make your own special jigs and fixtures. Determine where you need a bushing, and then drill a 9/16" hole. These inserts are 5/8" in diameter and will fit securely in the 9/16" hole. The bushings are about 1/2" long. Each number includes three pieces.

232-6110 .....	1/8"
232-6111 .....	3/16"
232-6112 .....	1/4"
232-6113 .....	5/16"
232-6114 .....	3/8"

Dowel and Tenon Centers

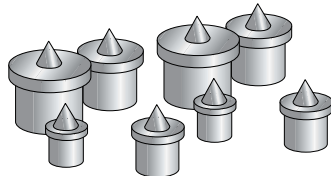

Steel dowel and tenon centers for accurate transfer of dowel holes and tenons. Scribe points and internal centering pins make for accurate drilling guides. Set includes eight pieces, with two each of four tenon sizes 3/16", 1/4", 5/16", 3/8" inside diameter and corresponding dowel sizes of 3/16", 1/4", 5/16", 3/8" and 1/2". Individual sizes are sold in tens.

210-1040 .....	1/4"
210-1050 .....	5/16"
210-1060 .....	3/8"
210-1080 .....	1/2"
350-0889 .....	8 Piece Set

Shelf Pin Drill Jig

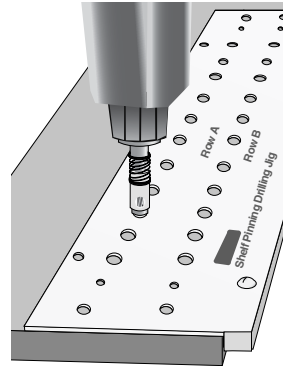

Great accuracy and speed for all of your shelving projects. This jig precisely spaces shelf pin holes 1/4" apart as well as 37mm or 64mm from the edge. In addition, simply index the 20" long template with a shelf pin and extend the range of this jig for any length run of holes. Use with either face frame or frameless construction. Comes with a 1/4" self-centering bit.

825-6585 .....	Shelf Pin Drilling Jig
825-6586 .....	1/4" Self-Centering Bit Only
825-6587 .....	5mm Self-Centering Bit Only

Precision Drill Guide

This is an accessory that every drill owner should have. Perfect for repetitive and accurate drilling, it will also allow you to do work that is impossible to do by hand alone. Round stock is automatically centered in a V-groove.

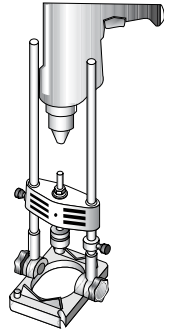

825-4200 ..... Precision Drill Guide

Drill Guide Kit

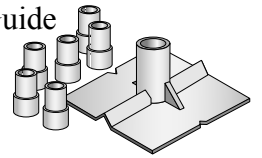

This is the easiest way to make sure you drill straight and true holes in a wall, on a flat surface, edge, cylinder, or sphere. Pop a bushing into the plastic guide and you are set to go. Centerpunch-locator tool is included. Includes bushings for 3/16", 1/4", 5/16", 3/8", 7/16", and 1/2" bits.

800-2860 ..... Kit

"V" Center Jig



The troublesome nature of drilling squarely into round objects is eliminated with the V Center Jig. Attach it to a drill press table or other stationary surfaces for right angle and centered drilling.



Also, use it to hold dowels and round stock for hand sawing. Made of aluminum.

828-4250 ..... V Center Jig

Drawer Pull Installation Jig



A simple, no-fuss clear acrylic jig for locating and marking drawer pull locations. Using the adjustable fence, set the jig from the drawer's top edge, align the center line with drawer's center and mark pull's location.

825-5400 ..... Drawer Pull Installation Jig

Self-Centering Doweling Jig

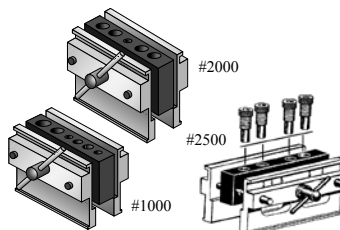

These jigs feature automatic self-centering action to assure accurate center drilling every time, even on round objects. All jigs have a two inch capacity, and drill guides are hardened for years of use. The basic model has six permanent drill holes in sizes 3/16", 1/4", 5/16", 3/8", 7/16", and 1/2". Made in the USA.

230-1000 ..... Model 1000

The Model 2000 has two threaded holes on 3/4" centers that accept drill bushings of 1/4", 5/16", and 3/8" (two of each included). There are two permanent drill holes in 7/16" and 1/2" sizes.

230-2000 ..... Model 2000  
230-3002 ... One each 1/4", 3/16", 3/8" Bushings

The Model 2500 comes with threaded drill bushings of 1/4", 5/16", and 3/8" that fit in the four threaded holes on the center block of the jig. Two bushings of each size are included.

230-2500 ..... Model 2500  
230-3002 ... One each 1/4", 3/16", 3/8" Bushings



SHARPENING

Soft Arkansas Stone

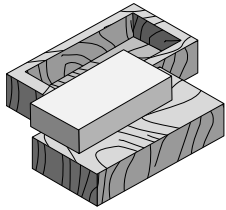

The soft Arkansas Stone is the best general purpose stone, and will quickly produce a sharp edge on your knives and tools.

- 340-1050 .....4" x 2" x 1"
- 340-1100 .....6" x 2" x 1"
- 340-1125 .....6" x 2" x 1/2"
- 340-1150 .....8" x 2" x 1"

Hard Arkansas Stone

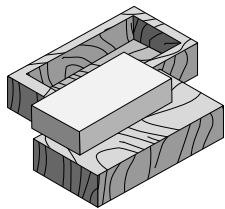

The hard Arkansas stone is for polishing an already sharp blade. Sharpening with this stone takes a little longer, but the exceptional edge is well worth it.

- 340-1200 .....4" x 2" x 1"
- 340-1250 .....6" x 2" x 1"
- 340-1300 .....8" x 2" x 1"

Black Hard Arkansas Stone

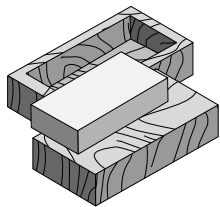

After an edge is prepared on a softer stone, the Black Hard Arkansas Stone is traditionally used as the final finishing stone. It provides a polished surface and reduced edge raggedness. It can be used to touch-up slightly dull edges but it is not meant for coarse grinding type applications. Definitive sharp edges require use of the Black Hard Arkansas stone.

- 340-1430 .....4" x 2" x 1/2"
- 340-1435 .....6" x 2" x 1/2"
- 340-1440 .....8" x 2" x 1/2"

Honing Oil



Honing Oil. This oil is the right "weight" for use with all oil stones. Three ounce bottle.

- 340-2600 .....Honing Oil

Combination Arkansas Stone

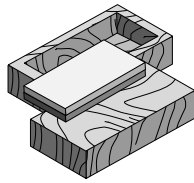

Begin sharpening on the soft Arkansas side, and finish the edge on the hard Arkansas side.

- 340-1450 .....4" x 2" x 1/2"
- 340-1500 .....6" x 2" x 1/2"
- 340-1508 .....8" x 2" x 1/2"

Soft/Black Combination

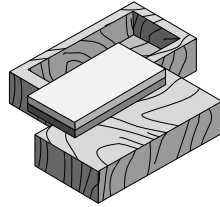

This combination stone offers the general-purpose qualities of a Soft Arkansas stone with the finishing capabilities of the Hard Black Arkansas stone. If you want just one sharpening stone, this combination stone is a good choice.

- 340-1530 .....4"
- 340-1535 .....6"
- 340-1540 .....8"

Pocket Stones

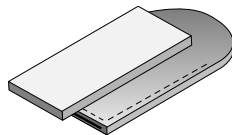

Natural Arkansas Stone in top grade genuine leather pouch. Excellent for small pocket knives.

- 340-1550 .....3" x 1" x 1/4" ..... Soft
- 340-1600 .....3" x 1" x 1/4" ..... Hard

Combination Stone

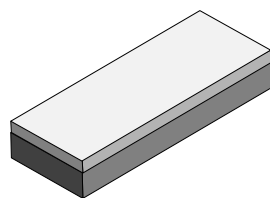

These rapid cutting stones will prove a pleasure to use. Coarse India on one side for basic sharpening and fine India stone on the other for the final edge.

- 340-1526 .....6" x 2" x 1"
- 340-1528 .....8" x 2" x 1"

Slip Stones

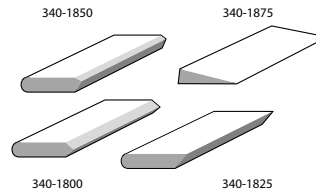

Four varied profile India slip stones for those hard to get angles and corners.

All stones 2 1/4" x 7/8" x 3/16".

- 340-1800 .....Slip Stone - A
- 340-1825 .....Slip Stone - B
- 340-1850 .....Slip Stone - C
- 340-1875 .....Slip Stone - D
- 340-1900 .....Set of Four

Round Edge Slip Stone

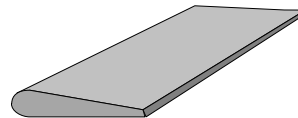

This round edge stone is for working with curved edges and for deburring and polishing. Excellent for wood-carver's tools.

- 340-1700 ..... Soft Arkansas ..... 4 x 2 x 1/2
- 340-1650 ..... Hard Arkansas ..... 4 x 2 x 1/2
- 340-1720 ..... Fine India ..... 4 1/2 x 1 3/4 x 3/8

Gouge Slip

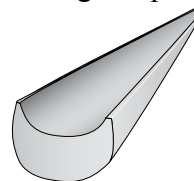

The one tool that no carver likes to be without when it's time to sharpen a gouge. Fine grit tapering India gouge slip is a must for anyone who needs to put an edge on a curved surface. Size is 6" x 2" x 1/2" x 3/8".

- 340-2000 .....Gouge Slip

Combo Slip Stones

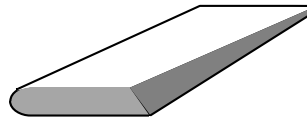

With different edge configurations, these stones will sharpen just about any carving tool from gouges to V-grooves. One edge is shaped round and tapers from approximately 1/8" to 1/2". The other edge is straight and has an angled taper. Stones measure approximately 2" x 4". They are best used in conjunction with each other, with the Soft Arkansas as the first to be used followed by the Hard Arkansas to finish the cutting edge.

- 340-1775 .....Soft Arkansas
- 340-1785 .....Hard Arkansas

**Sharpening Stone Materials**  
Arkansas stones are found in the state with the same name. Experts sort and grade this natural material carefully so that you will get the sharpening characteristics you expect. Still, some differences in color and other characteristics are to be found when comparing one stone with another. Arkansas stones have proven themselves to generations of tool users.

Arkansas File Set

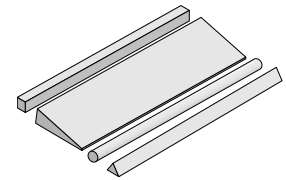

File Set contains the most used files for woodcarvers, gunsmiths, and machinist. Boxed for protection. Each stone is 4" long.

- 340-1750 .....File Set

Tri-Hone

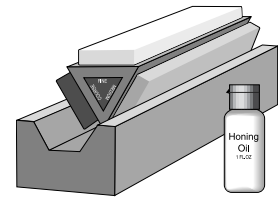

Quality edge tools cannot be properly sharpened with only one stone. You need a courser stone to start, and then work your way through finer stones for a truly sharp edge! Here are three oil stones mounted on a triangular cedar base so that you can easily work your way to a great cutting edge. Includes Aluminum Oxide stone (course), Soft Arkansas, and Hard Arkansas stones.

- 340-2550 .....6"
- 340-2580 .....8"

Sharpening Kits

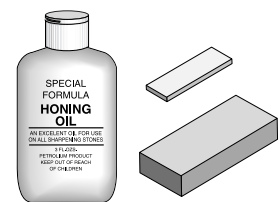

Comes complete with a soft Arkansas, hard Arkansas, & bottle of honing oil—all in a plastic storage box. Great for all pocket knives and small hunting knives.

- 340-2500 ..... Small
- 340-2525 ..... Large



### Honing Guide

If order to get best performance from chisels and plane blades it is mandatory for them to be razor sharp. Sharpening requires a back and forth motion and, when holding the tool without a guide, it's impossible to maintain the same angle during this motion and impossible to know what the bevel angle actually is. This easy to use guide attaches to the cutting tool and the sharpening angle can be easily determined. With a simple rolling motion razor sharp edges are gained. When using, keep firm pressure on the cutting edge and less on the roller thus minimizing stone wear. Creating precise secondary angles are also a snap. For chisels up to 1 5/8" wide and plane blades up to 2 5/8" wide.

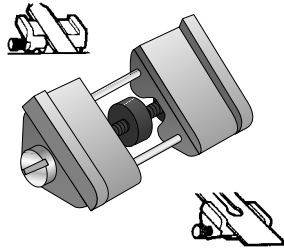

800-1800 .....Honing Guide

### Two Cherries Sharpening DVD



An instructional DVD from Two Cherries covering the sharpening of chisel and plane blades, as well as a wide range of carving tool sweeps and sizes, from 1mm micro gouges to 3" fishtail tools, V-tools, and more. The sharpening methods demonstrated use only easy to find sharpening equipment and shop-made jigs. The techniques do not require the use of hard to find or expensive equipment. The instructor also shows how to repair and restore a damaged cutting edge. DVD can be played in English, Spanish, German, Dutch, or French. Approximately 73 minutes. 524-7500..... Sharpening Video

## RICHARD KELL HONING GUIDES

### Chisel Honing Guide



With a refined construction featuring solid brass bobbins, a delrin roller and a stainless steel guide rod, these honing guides allow sharpening of a variety of chisel shapes and plane irons. For chisels ranging in width from 1/8" to 1 1/8", as well as, narrow and short chisels, use the smaller guide. For chisels and plane blades up to 2 5/8" use the larger guide.

625-5500 .....0 to 1" capacity  
625-5600 .....0 to 2 5/8" capacity

### Bevel Gauge

Indispensable quick check for grinding and honing. Has the twelve most common angles between 15° and 120°. Comes with hole for key chain so you can keep it handy. Made in England, of solid brass, by Richard Kell.



625-3000 .....Bevel Gauge

### Conventional & Skew Honing Guide



The correct working face is used as the datum. Accurate hardened steel dowels provide the 90° datum for plane irons and chisels. A spring loaded pin provides location for Lie Nielsen skew blades, otherwise any skew can be held by using a slip of hardwood against the appropriate steel dowel. Clamping is by a wooden wedge, pattern provided. Full and comprehensive leaflet included. Exceptional quality in solid brass and stainless steel.

625-5700 .....0 to 2 5/8" capacity

### The Complete Guide to Sharpening



This is the definitive tool-sharpening book. Lee covers both the practical and technical information needed to sharpen tools quickly and efficiently.

415-1620 .....The Complete Guide to Sharpening

### Wheel Dresser



In order to keep your grinding wheels in top-notch condition use this diamond tipped wheel dresser on a regular basis. Not only trues the face of the wheel, but cleans the face so that the grinding wheel will sharpen your tools faster and with less chance of burning the steel of the tool. Made in India.

885-5025 .....Wheel Dresser

## SHARPENING GUIDES

veritas®

### Mk.II Honing Guide



860-8510

860-8520

Designed to make honing a chisel or plane iron fast with great accuracy. The blade registration system assures that the blade is square and the bevel is correct quickly and accurately. The clamping mechanism registers on the face of the blade, and is designed to accept flat and tapered blades. A three-position eccentric roller allows a microbevel to be honed easily. The tool will easily handle chisels 1/4" and blades as wide as 2 7/8" and 1/2" thick. The skew registration accessory allows you to quickly set both skew and bevel angles of chisel and plane blades, while the camber roller assembly facilitates putting a slight curve on the edge of a plane iron – desirable when using a smooth plane on large surfaces.

860-8500 .....Mk.II Honing Guide  
860-8510 .....Skew Registration Jig  
860-8520 .....Camber Roller Assembly

### Honing Compound



Made from a blend of abrasives that will quickly hone steel tools (both carbon and high-speed) to a mirror finish. For use on leather wheels, leather strops and shaped wooden forms.

860-6550 .....6.5 oz Honing Compound

### Grinder Accessories

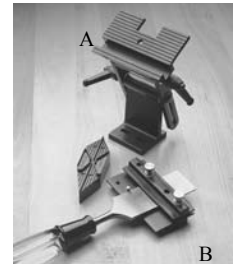

This tool mounts directly to the bench in front of your 6" or 8" bench grinder (it can be readily folded out of the way). It's 4" wide table straddles up to 1" wide wheels. Perfectly suited to the Veritas grinding jig and skew grinding jig.

860-2095 .....A.....Grinder Tool Rest

Clamp the tool to be sharpened in the jig adjusting the amount of blade projection you need for the bevel angle you want. Index lines ensure perfect alignment. Design will work with virtually all hand or power grinders.

860-2085 .....B.....Grinding Jig

### Honing Guide & Angle Jig



The Veritas Honing Guide has a very wide roller, and is uniquely suited to adding a micro bevel after sharpening. Simply hone then turn the guide setting knob and give it a few more strokes. Especially useful when used with the angle jig which has the five most common bevel angles built into a pentagon wheel.

860-3010 .....Honing Guide  
860-3020 .....Angle Jig  
860-3021 Set / Honing Guide & Angle Jig





SHARPENING

Japanese Water Stones

A superior quality water stone, made to the finest Japanese specifications. These stones cut very fast, but still leave the finest edge! Stones need be soaked for thirty minutes before using, but can remain in the water indefinitely after the first use. This is a full line of quality sharpening stones for the serious woodworker.

Bench Stones

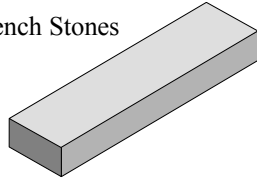

Start sharpening with a coarser stone, then proceed progressively to finer grits. For some, the 6000 grit finish stone will provide a perfect edge, while others will require the use of the still finer 8000 grit gold stone.

- Size 8 7/16" x 2 1/8" x 1 1/4"
- 705-0800 ..... 800 grit
- 705-1000 ..... 1000 grit
- 705-1200 ..... 1200 grit
- Size 8 1/2" x 3 1/8" x 1 1/4"
- 705-2000 ..... 1000x6000 double sided
- Size 7 1/2" x 2 3/8" x 5/8"
- 705-2010 ..... 6000 grit Small Finish
- Size 8 1/8" x 2 1/8" x 3/4"
- 705-2040 ..... 6000 grit Large Finish
- Size 8 1/8" x 2 1/8" x 7/8"
- 705-3000 ..... 8000 grit Gold Finish

Gouge Stones



Tremendously helpful stone is six inches long and tapers from 2 5/16" to 1/16". Makes sharpening gouges much easier.

- 705-4005 ..... Coarse 180 grit Gouge Stone
- 705-4010 ..... Medium 1000 grit Gouge Stone
- 705-4015 ..... Fine 4000 grit Gouge Stone

Tool Sharpener



Three extremely useful and easy to use sharpening tools each with diamond sharpened tungsten carbide inserts. All feature the same comfortable-to-hold aluminum handle with incorporated guard and tapered head. Each of these tools comes with a pouch for storage and protection while not in use. Clearly worded and illustrated instructions are also included with each. Made in France.



Fitted with a V form solid tungsten carbide insert, where the tops of the V form the cutting edges and are

used with a stroking action along the edge of the tool that requires sharpening. Excellent for sharpening axes, drawknives, scissors, scythes, shovels and any number of tools that do not need a polished razor's edge.

- 847-6100 ..... One Insert



Fitted with the same V form insert in solid tungsten carbide as the 847-6100 above, but on the other side of the tapered head, has a second insert, this one round with a diamond ground helical chip-breaker which is used after the V insert to remove any burrs and refine the edge. This second insert also works as a quick touch-up between sharpenings. Excellent for sharpening pocket, shop or kitchen

knives whether in stainless or carbon steel. With this tool a truly refined and polished edge can be achieved on most any tool.

- 847-6150 ..... Two Inserts

Makes burnishing easy! Diamond ground inserts in solid tungsten carbide make short work of preparing and turning the burr on even the hardest of cabinet scrapers, both curved and rectangular. The incorporated hand guard and the fact that the inserts are very near the hand permit the user to apply a strong and constant pressure with great precision. On one side, a round polished insert is perfect for "ticketing" or case hardening the scraper edge. This insert also is excellent for fine turning of scrapers. On the other side, a triangular insert with a polished acute angle is excellent for aggressive turning of even the thickest of scraper blades.

- 847-6200 ..... Burnisher



Nagura Stone

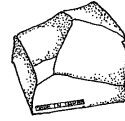

This carefully selected natural stone is used for creating a slurry on the surface of finish stones during sharpening procedures. Made in Japan.

- 205-6000 ..... Nagura Stone

Carving Tool Slip

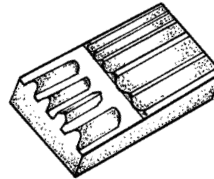

These 1000 grit waterstone slips have several shapes for sharpening all types of tools. The size of the stone is 150mm x 56mm x 25mm. Made in Japan.

- 700-9010 ..... Carving Tool Slip

Sharpening Strops



"Wood is Good" tool strops come in two sizes, and enables one to put that razor edge on cutting tools. The smaller strop is perfect for most carving tools, while the larger version was designed to give the space needed to sharpen plane iron blades. Both have 'rounded' and 'V' edges for those hard-to-sharpen shapes. Sizes shown are for the strop excluding handle. USA.

- 170-4100 ..... 1 3/4" x 7"
- 170-4150 ..... 3" x 9 1/2"
- 170-4200 ..... Abrasive (1 oz)

Resurfacing Stone



An 8" x 2 1/8" x 1" resurfacing stone comes with wide diagonal corrugations or channels and is designed for flattening waterstones. Typically well-used waterstones develop hollow areas and the stone's usefulness is then minimized. The resurfacing stone's coarse grit and the water/debris clearing diagonal channels can quickly return worn sharpening stones to a flat condition. Highly recommended.

- 705-5000 ..... Resurfacing Stone

Honing Guide



This product was originally designed for use with traditional Japanese tools, but can be put to good use with Western style tools as well. Great for flattening the backs of cutting tools. Made in Japan.

- 760-2050 ..... Honing Guide

Water Stone Base

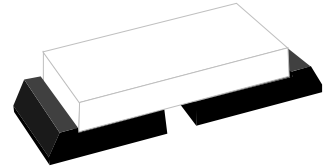

Here is a great solution to holding water stones securely during use. Rubber base consists of two parts which go on opposite ends of the water stones. Works like a charm. Made in Japan.

- 705-0010 ..... Stone Base

Stone Holder

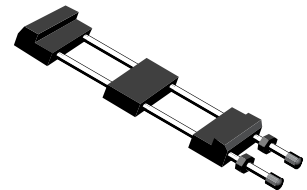

Great for diamond and Arkansas stones, this stone holder has rubber ends that hold the stone, as well as keep the stone from moving on your bench. Fits stones 5 1/2" to 9" long. Arms are chrome plated. Made in Taiwan.

- 825-2475 ..... Stone Holder

Sharpening with Waterstones



Anyone can learn how to sharpen every kind of woodworking tool, with a minimum of equipment and fuss. Ian Kirby presents a detailed, no-nonsense handbook that includes plans for a terrific grinder tool rest, and a dedicated sharpening bench.

- 410-1060 ..... Sharpening with Waterstones





### Hock Burnisher Rod

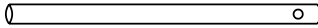

This 3/8" x 6" burnisher is hardened to Rc64 & polished to a mirror finish. For the woodworker wanting the finest quality in a burnisher, this is it. Handle may be easily fitted. (Hock)

110-1375 ..... Burnisher

### Variable Burnisher

Veritas®



Set the hook angle you want and burnish a clamped scraper. A precision-ground tungsten carbide rod in the brass angle-setting knob is held at exactly the right angle as you burnish. The ergonomic, injection-molded body keeps hands safely clear of sharp edges, and allows you to apply as much pressure as you wish. Nylon body with brass fittings.

860-2175 ..... Variable Burnisher

### Cabinet Scraper

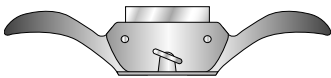

Cabinet scraper in the traditional #80 style will produce the finest possible surface. Use a burnisher for sharpening the blade.

580-2000 ..... Kunz Scraper #80  
580-2005 ..... Blade Only  
110-5080 ..... Hock Scraper Blade

### Scraper Plane

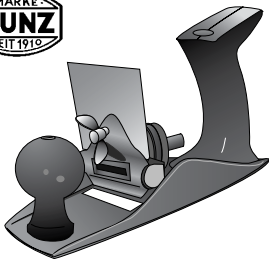

For the final finish operation on your wood, nothing can compare to scraping. This scraper plane is similar to a bench plane in style. Comes standard with a plain edge blade, but a toothed blade is offered as an accessory. Kunz

580-2150 ..... #112 ..... Scraper Plane  
580-2155 ..... Blade Only  
580-2160 ..... Toothed blade Only  
110-5112 ..... Hock Scraper Blade

rlc200906

### HSS Round Burnisher

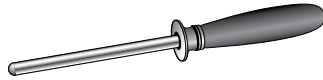

Clifton saw the need for an exquisitely designed and executed burnisher. The smooth high speed steel round blade will turn an edge easily. The wooden handle is comfortable to hold, and the brass extended shank protects your hand should you slip while turning the edge of your cabinet scraper. Made in England.

635-9700 ..... Hss Round Burnisher

### Polished Burnisher



The traditional burnisher has been refined and perfected by Veritas. Given a new shape, this tool can take the place of separate oval, round, and triangular tools. In addition, the properly hardened steel is highly polished to make the job of burnishing a hook on your scraper even easier and more accurate.

860-2180 ..... Burnisher

### Scraper Holder

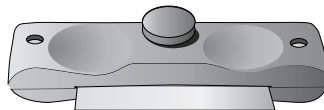

The Scraper Holder completely eliminates burned and tired fingers from intensive blade use. Made to fit all standard scraper blade thicknesses. Made in Taiwan.

825-6590 ..... Scraper Holder

### Scraper Holder

Veritas®



Holds a scraper of 6"/150mm of any thickness. Simply clamp the scraper in position and set the amount of bow with the screw-actuated center pad. Made to fit your hands comfortably. Veritas

860-2200 ..... Holder



### Two Cherries Scrapers and Burnishers



Two Cherries brand scrapers and burnishers are manufactured to the highest quality standards. For more than one hundred and fifty years this German brand has been known and respected.

#### Cabinet Scrapers

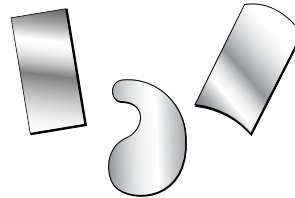

The finest German steel. Ideal tool for refinishers. Regular rectangle, curved on opposite ends, and the classic "goose-neck" shape. Set includes 0.8 mm rectangle, curved, and gooseneck scrapers with or without the oval burnisher. Use a burnisher to sharpen.

520-5005 ..... 0.6 mm Rectangle  
520-5010 ..... 0.8 mm Rectangle  
520-5060 ..... Curved  
520-5070 ..... Gooseneck  
520-5510 ..... Set of Scrapers (3)  
520-5500 ..... Scrapers (3) & Burnisher

#### Burnishers

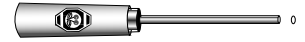

Oval Burnisher



Triangular Burnisher



Round Burnisher

Burnishers for sharpening hand and cabinet scraper blades. All styles include handle and are approximately 9 1/2" in overall length.

520-5080 ..... Oval  
520-5085 ..... Triangular  
520-5090 ..... Round

### Professional Scraper



This Two Cherries scraper is specially prepared to let you get to work faster. The two long edges are square and have been worked so that they are smooth, without scratches that will end up showing on the wood surface. This saves you the tedious job of filing the edge square and then honing all the scratches from the area that you have just filed. With this scraper that part of the job has already been done, so just grab your burnisher and turn the edge.

520-5750 ..... Scraper with Prepared Edges

### Scraper Wallet

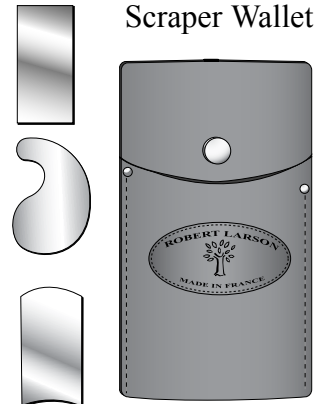

It's almost a wonder that this storage wallet wasn't thought of ages ago. This is the best way to store all of your flat metal scrapers. After spending so much time filing, then honing, and finally turning an edge with a burnisher — why ruin all that work by simply throwing your scraper into your toolbox or stacked up in a pile of tools. This will protect all of your hard work. Internal dividers keeps each scraper from working against another. Available alone, or with three Two Cherries scrapers. Fits a maximum of five scrapers.

845-1050 ..... Leather Scraper Wallet  
520-5575 ..... Wallet with Three Scrapers



## ANANT PLANES

## Planes for the Trade

Anant planes, made in India, are nicely finished and will not destroy your budget! Spend a little time "tuning" these tools and you will neither regret your investment, nor the money saved. In fact, you might be able to consider getting an extra plane or two with the savings! Consider adding a Hock replacement iron and chip iron to upgrade an already fine product.

## Bench Planes

The body of these planes are ribbed to ensure strength and rigidity. The machined faces of the frog bed sit firmly onto similar machined faces on the body of the plane and then fastened in position by two screws. This positive positioning helps prevent chattering. The cut iron is made of high carbon steel, hardened and tempered under scientific control for accuracy and uniformity. Handle and knob are hardwood.

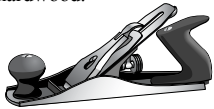

The traditional finishing or smooth planes. The number four can also be used as an all purpose plane for a variety of work.

895-1300 ..... Bench Plane A3 - Smoothing  
895-1400 ..... Bench Plane A4 - Smoothing



The number five plane is typically considered to be the "jack of all trades" and is the correct choice if you will only have one plane in your tool box.

895-1500 ..... Bench Plane A5 - Jack  
895-1600 ..... Bench Plane A6 - Fore



These planes are long enough not to ride the peaks and valleys of your material making them the choice for flattening timbers.

895-1700 ..... Bench Plane A7 - Jointer  
895-1800 ..... Bench Plane A8 - Jointer

Quality Tools

## Bench Rebate Plane

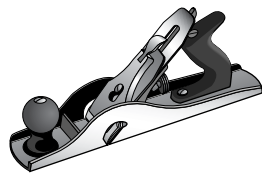

Same quality construction as the bench plane series. This thirteen inch long plane is fitted with a two inch wide blade that matches it's two inch wide body. Recommended for general rabbeting work where a heavy section is being cut.

895-4100 ..... Bench Rebate Plane A10

## Circular Plane

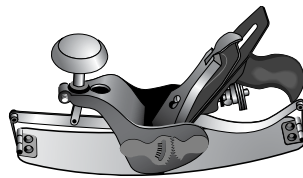

Designed for use on concave and convex surfaces. This plane features a flexible steel face that is anchored at each end to the body of the plane. Center screw adjustment enables the desired curvature of the sole to be set quickly and positively.

895-4200 ..... Circular Plane A113

## Plough Plane

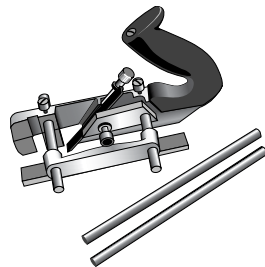

Ploughs nine sizes of grooves from 1/8" to 3/8" in width to a depth of 3/8" at any distance up to five inches from the edge of your work. There is a certain sense of satisfaction that one gets when using a tool that has been in use by generations of woodworkers. Wooden handle is comfortable to use. You may find that this versatile tool is easier and faster to use than setting up and using power tools for certain applications

895-3100 ..... Plough Plane A52 (8 Cutters)

## Block Plane

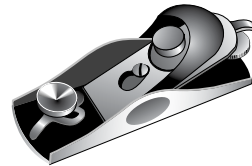

This plane is fully adjustable and capable of fine accurate work. The screw adjusted cut iron is held firmly in position by a lever and cam. The mouth of the plane is adjustable for fine or coarse work.

895-2000 ..... Block Plane A9 1/2

## Bullnose Rebate Plane



This 1 1/2" inch rebate plane has an adjustable mouth that is adjusted by use of the provided shims. Removing the front turns this into a bullnose plane.

895-4400 ..... Bullnose Rebate Plane A77

## Adjustable Spokeshaves

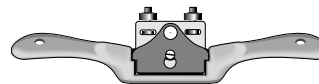

Spokeshaves offer smooth plane-like finishes and can be used on a variety of straight, flat and curved, concave and convex surfaces. Ideal for furniture makers and wood carvers. Easy to adjust.

895-1000 ..... Flat Bottom  
895-1050 ..... Round Bottom

## Multi Plane

Not Illustrated

This tool will perform a wide range of planing operations including ploughing, dadoing, beading, rabbeting, and slitting. Irons are set by means of a screw adjuster. Includes twenty-three irons as standard. Packed in a wooden box.

895-3000 ..... Multi Plane A405 (23 Cutters)

## Low Angle Block Plane



This is an indispensable plane for any woodworking shop. It can be used on plastic laminates, end grain, edges and touch-up work on any flat surface. The low angle blade is fully supported, thus minimizing annoying blade vibrations. It is accurately machined and finished with a durable high gloss stoving enamel. The cutter sits at 13 1/2 degrees. Overall plane length is six inches.

895-2500 ..... Low Angle Block Plane 60 1/2

## Rebate Plane

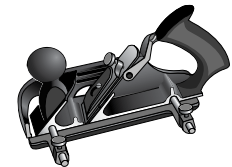

The model 78 rebate plane will cut accurate rabbets up to 1 1/2" wide. The adjustable fence is held in position by two fence arms. Bullnose blade position is provided for use when needed.

895-4300 ..... Rebate Plane A78

## #39 Rebate Plane

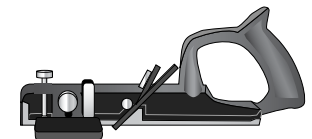

This traditional plane is eight inches in length and has a 1/2" blade which is the full width of the plane body. The blade is set at an angle for smooth cuts and features a screw adjustment depth gauge. Includes a depth stop.

895-4500 ..... Rabbet Plane #39

## Replacement Irons

These are the same irons found on the planes on this page. While you might not need a replacement iron for years to come, having a spare iron, already sharpened, can speed your work along when you would rather be planing than sharpening and honing.

895-9100 ..... Spare Iron for Spokeshaves  
895-9145 ..... Spare Iron 45mm for A3  
895-9150 ..... Spare Iron 50mm for A4 & A5  
895-9160 ..... Spare Iron 60mm for A6 & A7  
895-9166 ..... Spare Iron 66mm for A8  
895-9200 ..... Spare Iron A9 1/2 Block Plane  
895-9250 ..... Spare Iron A10 Bench Rebate  
895-9300 ..... Spare Iron A78  
895-9350 ..... Spare Iron A77  
895-9400 ..... Spare Iron 39



ANANT PREMIER

The Anant Premier Series Of Hand Planes

The Premier Series are similar in size and function to the standard Anant planes. However, the Premier Series also includes refinements and other important improvements and upgraded features. They have more accurately ground surfaces, brass hardware, an overall tool refinement and an improved enamel finish. They are reminiscent of planes long out of production and they are planes for woodworkers wanting high quality tools.



899-2000 ..... #9 1/2 Block Plane

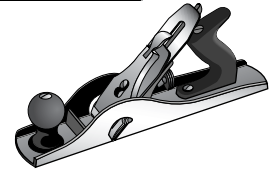

899-4100 ..... #10 Bench Rebate Plane

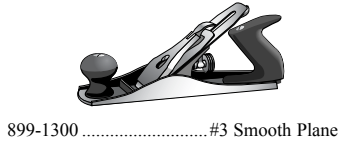

899-1300 ..... #3 Smooth Plane

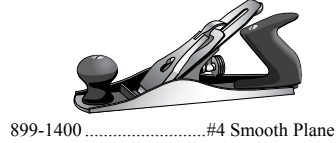

899-1400 ..... #4 Smooth Plane



899-2500 ..... #60 1/2 Low Angle Block Plane



899-4400 ..... #77 Bullnose Rebate Plane



899-1450 ..... #4 1/2 Smooth Plane

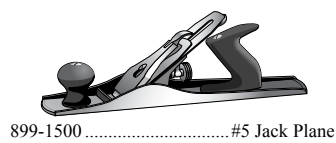

899-1500 ..... #5 Jack Plane

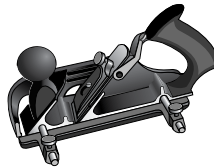

899-4300 ..... #78 Rebate Plane



899-1550 ..... #5 1/2 Smooth Plane

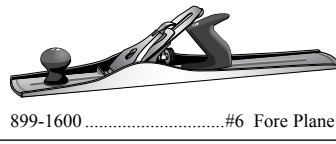

899-1600 ..... #6 Fore Plane

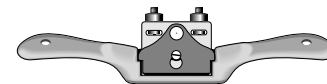

899-1000 ..... Flat Bottom Spokeshave

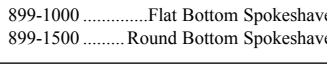

899-1500 ..... Round Bottom Spokeshave

Replacement Blades for Premier Planes

- 899-9100 ..... Spokeshaves
899-9145 ..... #3 Bench Plane
899-9150 ..... #4 and #5 Bench Planes
899-9160 ..... #4 1/2 and #5 1/2 Bench Planes
899-9166 ..... #6 and #8 Bench Plane
899-9200 ..... 9 1/2 Block Plane
899-9250 ..... #10 Bench Rebate
899-9300 ..... #78 Rebate Plane
899-9350 ..... #77 Bullnose Rebate Plane
899-9400 ..... 60 1/2 Block Plane

HOCK IRONS



The world's finest blades for hand woodworking tools for over twenty years! Hock Tools is a small metalworking cottage industry located in the middle of Mendocino's renowned wood-working enclave. For many years Hock tools have been handcrafted to satisfy the demands of the most discriminating professional.

Hock Double Irons

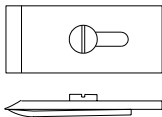

Extraordinary quality rarely found today. Great for producing your own wooden planes. All are double irons. Radius edged irons also available.

- 110-1100 ..... 1"
110-1125 ..... 1 1/4"
110-1150 ..... 1 1/2"
110-1175 ..... 1 3/4"
110-1200 ..... 2"
110-2125 ..... 1 1/4" (4"r) Radius-Edge Iron
110-2150 ..... 1 1/2" (5"r) Radius-Edge Iron
110-2175 ..... 1 3/4" (6"r) Radius-Edge Iron

Hock Bench Plane Irons

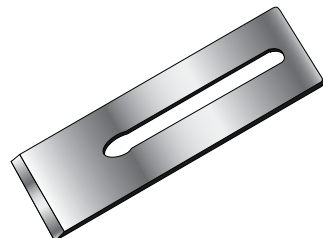

These single irons are replacements for most bench planes such as Anant, Footprint, Stanley, etc. All are now available in A2 steel as well! High carbon steel blades can be honed easier and sharper, while cryogenically treated A2 blades will hold an edge longer.

Table with 3 columns: Number, Fits, Width. Lists various Hock Bench Plane Irons and their specifications.

Hock Block Plane & Spokeshave Irons

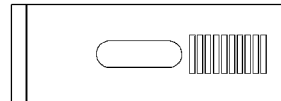

The highest quality replacement irons for block planes, spokeshaves, and radius-edge planes. All block plane irons and the adjustable spokeshave iron are now available in A2 steel!

- 110-4138 ..... 1 3/8" Plane Iron 7/16" Slot
110-4162 ..... 1 3/8" Plane Iron 7/16" Slot
110-4238 ..... 1 3/8" Plane Iron 5/8" Slot
110-4262 ..... 1 5/8" Plane Iron 5/8" Slot
110-0210 ..... 1 3/8" A2 Plane Iron 7/16" Slot
110-0220 ..... 1 3/8" A2 Plane Iron 7/16" Slot
110-0230 ..... 1 3/8" A2 Plane Iron 5/8" Slot
110-0240 ..... 1 3/8" A2 Plane Iron 5/8" Slot

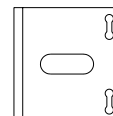

- 110-7151 ..... Adjustable Spokeshave Iron
110-0310 A2 Adjustable Spokeshave Iron
110-7175 ..... 1 1/4" Spokeshave Iron
110-7200 ..... 2" Spokeshave Iron

Chip Breakers



Upgrading the chip breaker in your old or new plane can be one of the best things that you can do to prevent chatter and tear-out. Available in three sizes, adding a Hock chip breaker to your planes will be a great investment in improving your work. Better yet, combine a Hock blade with one of these chip breakers - you will be glad you did!

- 110-3328 ..... 1 3/4"
110-3332 ..... 2"
110-3338 ..... 2 3/8"

Hock Scraper Irons



Two high quality scraper plane irons that allow you to upgrade your scraping tools quickly and easily. One is made for the Stanley #12 and #112 scraper planes, and the other for the #80 cabinet scraper. These blades have a forty-five degree bevel on the cutting edge. Hardened for a balance of long edge life and burr "rollability".

- 110-5080 ..... Fits #80
110-5112 ..... Fits #12 and #112





PLANES

Clifton – Sheffield, England

Spokeshaves

Clifton spokeshaves are made out of virtually unbreakable spheroidal graphite/malleable iron; the surfaces are finished and polished to give maximum comfort in the hand. These are not inexpensive tools, but neither are they compromised in any way.



635-6100 .....Convex #500  
635-6150 .....Spare Iron for #500



635-6200 ..... Concave #550  
635-6250 .....Spare Iron for #550

Wedged

Rebate Plane

A beautiful metal body plane with rosewood wedge to guarantee that the 3/8" blade is held securely. Body is machined from quality grey iron casting, accurately machined, and precision ground on the sole and sides. Overall length is 3 1/2"

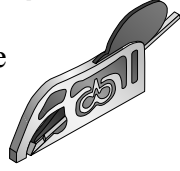

635-4500 ..... #400  
635-4501 .....Cutter for #400

Plane Irons & Cap Irons

Irons are hand forged of high carbon steel, and are nearly 50% thicker than normal blades. Used as a replacement iron in a standard metal body plane, you can be assured of the best cutting edge possible. For even better results, use in combination with the Clifton two piece cap iron below.

635-2134 ..... 1 1/4" | 635-2238 ..... 2 3/8"  
635-2200 ..... 2" | 635-2258 ..... 2 5/8"



Two piece cap iron applies pressure specifically to the end of the plane iron. Two-piece cap iron facilitates honing of the cutting iron, as the lower part can be easily removed without having to lose the original cap iron setting.

635-1134 ..... 1 1/4" | 635-1238 ..... 2 3/8"  
635-1200 ..... 2" | 635-1258 ..... 2 5/8"

Hock Wooden Spokeshave Irons

Two-threaded-post style spokeshave irons that lend themselves nicely to making your own wooden body spokeshave. Brass thumbnuts are included. The larger iron has a 2 3/4" cutting edge and is 4 7/16" x 3/8" overall. The smaller iron has a 1 1/2" cutting edge and is 2 1/2" x 7/16" overall. There is a wealth of information on the internet about wooden body spokeshaves. In particular, look for John Gunterman's TEACHSHAVE page for a lesson from the master.

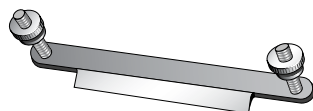

110-7044 ..... 1 1/2" Edge 110-7062 ..... 2 3/4" Edge

3 in 1 Rebate Plane

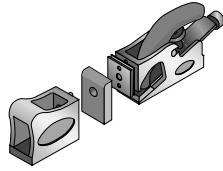

An extremely versatile tool, combining the features of shoulder rebate, chisel plane, and adjustable mouth bull-nose plane. The body is machined from a quality grey iron casting and precision ground on the sole and sides. Cutter is 1 1/8" wide, and overall length is 6"

635-3110 ..... #3110  
635-3111 .....Cutter for #3110

5/8" Rebate Plane

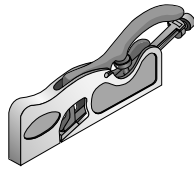

Tool provides a narrow, light, and accurate shoulder plane. Body is machined from quality grey iron casting, and precision ground on the sole and sides. Very fine mouth opening provides an exquisite cut. Iron is 1 1/16" wide, and the overall length of this plane is 5 1/2"

635-4100 ..... #410  
635-4101 .....Cutter for # 410

3/4" Rebate Plane

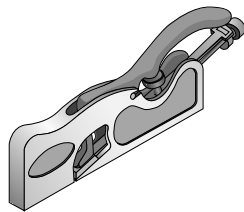

A light accurate shoulder plane. Body is machined from quality grey iron casting and precision ground on the sole and sides. Blade is 3/4" wide. Length is 8"

635-4200 ..... #420  
635-4201 .....Cutter for #420

Bullnose Rebate Plane

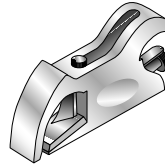

Bullnose rebate plane #90. With plane iron located very near the front end of the bed, a useful tool for planing rebates, surfaces near corners of frames, and other close work. Stanley England  
660-2000 ..... #90  
660-2041 .....Cutter for #90

Rebate Planes

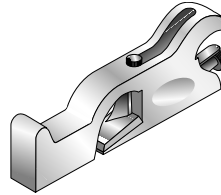

Rebate Planes made of fine grey iron castings. Plated finish. Adjustable mouth for fine or coarse work. Fronts are removable to make chisel planes. Model #92 is 3/4" wide. Model #93 is 1" wide. Stanley, England

660-2020 ..... #92  
660-2021 .....Cutter for #92  
660-2040 ..... #93  
660-2041 .....Cutter for #93

Cornering Tool Kit



Two cornering tools giving you cuts with a radius of 1/16", 1/8", 3/16", and 1/4". Easy to use, they cut on either the push or pull stroke. Kit includes both tools and a sharpening block used with 600x silicon-carbide paper to keep the tools in great cutting condition.

860-2030 .....Veritas Cornering Tool Kit

Block Plane Holster

Keep the block plane close at hand and free from tool box wear and tear. Whether using a ladder or out on the job side, this belt holster will keep the ever-needed block plane at arms reach.



845-1150 .....Block Plane Holster

Bullnose Rebate Plane



Fine grey cast iron body machined on base and sides. Ideal as a lightweight tool for trimming rebates. Stanley England  
660-2200 ..... Bullnose Rebate Plane #75  
660-2205 .....Iron for #75

Bullnose Rebate Plane

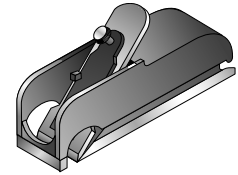

Bullnose rebating plane from the Kunz company of Germany. This is the classic model number 75 plane, 1 1/16" wide and 3 7/8" long.

580-2400 ..... #75  
580-2405 .....Iron for #75

Rebate Plane

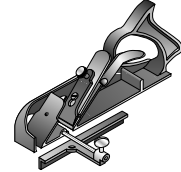

Rebating plane has a lever adjustment of the iron as well as a fence for guiding the work. In addition, the iron can be put into a front bullnose position. Kunz  
580-2600 ..... Rebate Plane  
580-2605 .....Replacement Iron Only

Side Rebate Plane

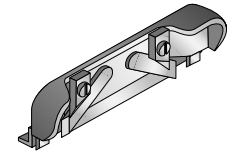

Side Rebate Plane #79 for right or left hand working. Nose pieces removable. Depth gauge. Blades can be individually set. Manufactured in Germany by Kunz.

580-2500 .....Kunz #79  
580-2501 ..... Pair Kunz Iron Only

Circular Plane

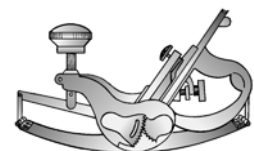

Circular plane with flexible steel bottom which can be adjusted to plane convex and concave surfaces. Kunz  
580-2700 ..... Circular Plane  
580-2705 .....Iron for Circular Plane





Spokeshaves

Spokeshaves



Kunz adjustable spokeshaves in both flat bottom and round-bottom versions. Every shop should have, at least, the flat bottom style -- which you will find yourself using more than you can imagine. Blade fits both styles. Made in Germany.

- 580-1000 .... Flat Bottom ..... Kunz #151
- 580-1050 .... Round Bottom .... Kunz #151R
- 580-1095 ..... Blade Only

Hollow Spokeshave



Spokeshave with hollow edge that is 10" long and fitted with a 2 1/16" blade. Certainly useful for working the wooden spokes of a wheel, but just as useful for the oars of a kayak as well!

- 580-1100 ..... Kunz #55
- 580-1105 ..... Iron Only

Chamfering Spokeshave



Long out of production, this chamfering spokeshave with adjustments for various settings is once again being made by Kunz.

- 580-1700 ..... Kunz #65

Cooper's Spokeshave



This may be called a cooper's spokeshave, but many woodworkers will find a wide variety of uses for this extra long spokeshave.

- 580-1800 ..... Coopers #56 Spokeshave
- 580-1805 ..... Blade Only



Double Spokeshave



Double spokeshave has a 1 3/8" hollow cutter and a 1 5/8" flat cutter. Depending upon the work that you are doing, this tool can speed things up a great deal! It certainly makes switching from flat to hollow spokeshave a breeze.

- 580-1300 ..... Kunz #60
- 580-1301 ..... Iron only Flat
- 580-1302 ..... Iron only Hollow

Adjustable Spokeshave

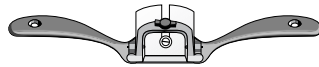

Spokeshave with adjustable mouth. This is the same spokeshave mentioned by James Krenov in the *Fine Art of Cabinetmaking*. If you are doing rough work, open the mouth to provide maximum clearance. If you are doing fine work, close the mouth for a finer cut.

- 580-1200 ..... Kunz #53
- 580-1205 ..... #53 Iron only

Round Edge Spokeshave



Comes with 2 1/16" iron. If you are doing hollowing work, you will find this spokeshave to be essential to your work.

- 580-1600 ..... Kunz #50
- 580-1605 ..... Iron Only

Light Spokeshave



These spokeshaves are perfect for light work as might be found in miniature woodworking or model making. About 9" long overall with a 1 3/4" blade. Flat or round bottom model.

- 580-1400 .... Flat ..... Kunz #64
- 580-1500 .... Round Bottom ..... Kunz #63
- 580-1505 .... Iron Only .. Kunz #64 or #63

Pocket Planes

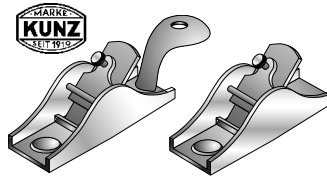

Both of these pocket planes are 3 1/2" long with a 1" blade. The raised handle model (sometimes referred to as a palm plane) is more comfortable to use for longer periods of time, while the plain pocket plane will fit into more and varied spaces. Handy for small, light work. The replacement blade will fit either models. These fine tools are made in Germany by Kunz.

- 580-2200 ..... Pocket Plane - Raised Handle
- 580-2300 ..... Pocket Plane
- 580-2301 ..... Blade for Pocket Plane

Kunz Plus  
9 1/2 Block Plane



The one hand plane for every woodworker. This one has been improved with better finishing on the heavy-cast body. Other improvements include a substantial brass knob, cap with easy to use tightening screw and an adjustable throat which can be closed to a very small/fine opening. The blades are cut on a CNC machine producing cleaner, better blades. This is a block plane superior to others, and will be the one reached for over and over again. Made in Germany

- 580-4600 ..... 9 1/2 Block Plane

Radius Plane

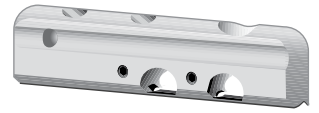

This is the easiest way to quickly radius the edge of your work. No need to set-up a router, simply reach for this radius plane and go to work. What makes this tool unique are the two carbide blades that make the cut. The leading blade takes off most of the material, while the second blade finishes the radius to a smooth finish. You will find yourself reaching for this tool over and over again.

- 825-5500 ..... Radius Plane
- 825-5510 ..... Pair of Blades Only

Kunz Plus  
#4 Bench Plane

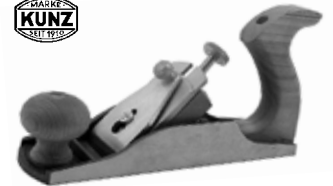

This plane combines all of the high-quality features of traditional bench planes, with innovative details and new design. The casting is stress-relief annealed grey-cast iron, and the iron is made from tool steel hardened to 60-62 HRC. It is seated optimally to prevent chattering. Easy and precise setting of the mouth opening is made by turning just a single screw. The sole is precision ground, and the sides are square to the bottom. Handle and knob are produced from native woods. Made in Germany

- 580-3400 ..... #4 Bench

Miniature Planes

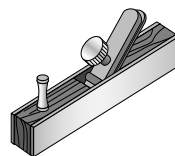

672-7050

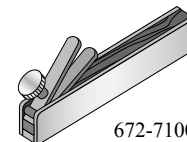

672-7100

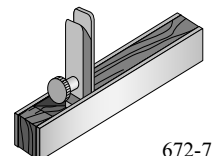

672-7150

Available in three distinct designs: block plane, bullnose plane and scraper plane. These are typically used when making models, jewelry boxes, doll houses and other fine items. They can also be used for delicate work on full-sized projects. Beautifully made of Rosewood and brass with 1/2" wide HSS blades. Each is under 3" in overall length. Made in India.

- 672-7050 ..... Block Plane
- 672-7100 ..... Bullnose Plane
- 672-7150 ..... Scraper Plane



WOODEN PLANES

ECE Improved Primus Smooth Plane



This is the top of the line Primus plane. The plane body is made of select fruitwood, while the bottom is lignum vitae. The throat opening is adjustable and the unique Primus adjustment regulator allows for quick and easy setting of the high quality iron. Germany  
535-1100 .....Reform Smooth Plane #711

ECE Primus Jack & Smooth Planes



Here are matching Primus Jack and Smooth planes. Both are made of quality steamed beech with lignum vitae sole. The difference is the bedding angle of the blade. The Jack plane will remove material more quickly, while the smooth plane leaves the finest possible surface finish. Germany  
535-1200 ..... Jack Plane #703P  
535-1300 .....Smooth Plane #704P

ECE Primus Rebate Plane



No shop is complete without a rebate plane, and this Primus rebate plane is a joy to use and easy to set. Germany  
535-1400 ..... Rebate Plane #710P

ECE Block Plane



ECE block plane is a tool that you will reach for without a second thought. This tool simply becomes a part of your hand and allows planing of small parts and on end grain.  
535-1600 ..... Adjustable Block Plane #649

ECE Primus Try Plane



If you are working to produce a flat and straight edge, you need a try plane. This Primus try plane is about as fine a tool as you can find, and will give you a lifetime of use. Germany  
535-1500 ..... Try Plane #701p

ECE Router Plane



This beautiful router, made of beech, is robust enough for heavy duty hand powered routing. It features a steel collar for securing the cutting blades and a large surface for working stability. Comes with three blades:  $\frac{7}{16}$ ",  $\frac{5}{8}$ " and  $\frac{13}{16}$ " widths. Germany  
535-1700 .....Wooden Body Router

Block Planes



Block plane made entirely of beechwood. Lacquered for protection, with hand support, horn, and steel button. Plane length of 240 mm with a double iron 48 mm wide. Holland  
835-1400 .....240 mm .....48 mm

Try Plane

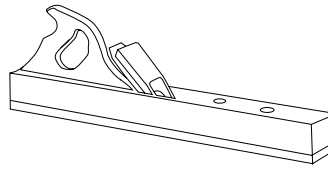

Trying plane with stonebeech sole. Lacquered for protection. With steel button. Plane length of 600 mm with a double iron 50 mm wide. Holland  
835-1600 .....600 mm .....50 mm

Rabbit Plane



A rabbit plane made of beechwood with stonebeech sole. Machined for precise results. Lacquered for protection. Plane length of 240 mm with a double iron 30 mm wide. Holland  
835-1800 .....240 mm .....30 mm

Wood Baller Set

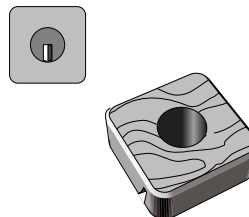

Set of three wood ballers that quickly round the end of a dowel. The end results are much like the ends on common household brooms, but there is no lathe work or manual shaping with rasp or files. Set includes tools for  $\frac{1}{2}$ ",  $\frac{3}{4}$ ", and 1" material.  
800-2895 ..... Wood Baller Set

Dowel Sizer

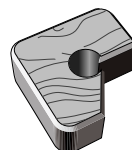

This simple tool will accurately size wood. Use on a slightly oversized dowel, or start with a roughly sized blank with all the corners removed. Set contains  $\frac{1}{2}$ ",  $\frac{3}{4}$ ", and 1" sizes.  
800-2885 .....Dowel Sizer Set

Wood Pointer

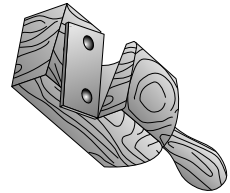

Easily and quickly apply a taper to the end of dowel. This wood pointer has a capacity to accept material up to 1" in diameter. Material does not need to be perfectly round to work in the tool.  
800-2890 ..... Wood Pointer

Threadbox & Tap

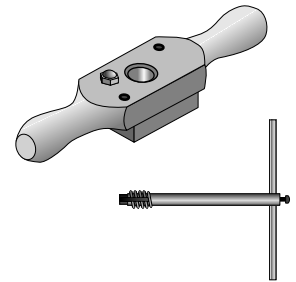

Nicely made wooden thread box for cutting threads on wooden dowels. Each size of thread box comes with a matching tap to complete the set. Available separately are bottoming taps that carry the threads produced by the standard tap nearly to the bottom of blind holes.  
800-1008 .... Threadbox & Tap ... $\frac{1}{2}$ " x 8 TPI  
800-1012 .... Threadbox & Tap ... $\frac{3}{4}$ " x 6 TPI  
800-1016 .... Threadbox & Tap ... 1" x 6 TPI  
800-1020 .... Threadbox & Tap ...  $1\frac{1}{4}$ " x 6tpi  
800-1024 .... Threadbox & Tap ...  $1\frac{1}{2}$ " x 6tpi  
800-1208 .... Bottoming Tap .....  $\frac{1}{2}$ " x 8 TPI  
800-1212 .... Bottoming Tap .....  $\frac{3}{4}$ " x 6 TPI  
800-1216 .... Bottoming Tap ..... 1" x 6 TPI  
800-1220 .... Bottoming Tap .....  $1\frac{1}{4}$ " x 6 Tpi  
800-1224 .... Bottoming Tap .....  $1\frac{1}{2}$ " x 6 Tpi  
800-1090 .....Cutter only for Threadboxes

"Plane" Beer Opener



Looks like a real wooden plane in your tool box. In reality it is a genuine beer and soft drink bottle opener. Holland.  
835-BEER ..... "Plane" Beer Opener



JAPANESE SAWS

Flush Cutting Saw

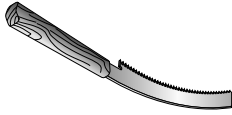

This flexible bladed saw is the perfect solution for trimming dowels or pegs. This tool will not mar the surrounding surface area.

720-3000 .....Saw

Small Tapered Flush Cut Saw



A flexible saw for flush trimming dowels and other small wood projections, the blade is meant for pulling towards the operator thus the blade is taut when in use. There is no set to the teeth so, used correctly, it will not mar the work surface. Approximately 8 1/2" in overall length with a 4" blade. It is 0.3mm in thickness with 26 teeth/inch and a 1.0mm pitch. Wood handle. Made in Japan.

770-4000 ..... Flush Cut Saw

Azebiki Saw



The azebiki saw is a mortise saw capable of starting a cut in the middle of the board by using a series of rocking strokes with the curved blade.

720-4100 ..... Azebiki Saw

Ryoba Saw



The Ryoba saw is a traditional Japanese carpenters saw. One side is used for rip cutting, the other for cross cutting. Handle is fully wrapped on all models. These saws cut on the pull stroke.

720-1200 .....Regular Quality  
720-1210 .....Better Quality

Dozuki Saw



The Dozuki Saw is the traditional Japanese dovetail or joint cutting saw. No other saw can equal the fineness of cut, thinness of kerf, or accuracy of cut. The dozuki, as all Japanese saws, cuts on the pull stroke. Two saws available.

720-2100 .....150mm Blade  
720-2200 .....240mm Blade

Replaceable Blade Saws

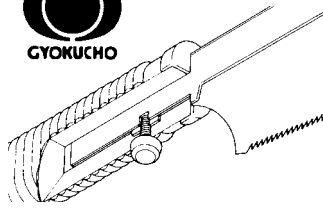

These replaceable blade saws combine modern and traditional design. Where indicated saws have hardened points -- giving extremely long life.

Ryoba (Carpenters Saws)



720-1500 .....240 mm - Hard Points  
720-1505 .....Ryoba Noko Blade Only  
720-1520 .....Seiunsaku Ryoba 270 mm  
720-1525 .....Seiunsaku Ryoba Blade Only

Dozuki Saws

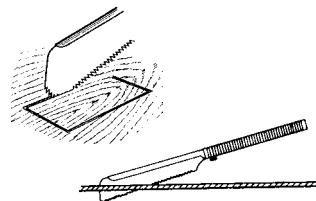

720-1550 .....240 mm - Hard Point  
720-1555 .....Dozuki Noko Blade Only

Edo-Me Crosscut Saw

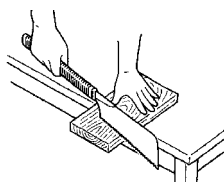

720-5600 ...Edo-Me ....240 mm .....Saw  
720-5605 ...Edo-Me ....240 mm Blade Only

Keyhole Saw

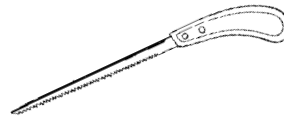

Very sharp teeth, cutting on the pull stroke enables this keyhole saw to do a fine job starting the cut from a small predrilled hole. Pull stroke cutting eliminates any buckling of the blade.

720-3100 .....Pistol Grip

Adjustable Keyhole Saw

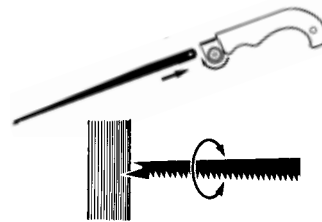

Nicely balanced tool with an adjustable blade. The very sharp teeth are designed to cut on the pull stroke, eliminating buckling of the blade while cutting. The specially designed tip allows you to "drill" into the material to start the cut.

740-3400 .....Keyhole Saw

Mini Saws



720-6510



720-6520



720-6530

Here is one of those "small can be better" situations . . . three small saws, all designed with a special purpose. If your work is smaller or perhaps a bit difficult to reach, one of these saws will work wonders. Pistol grip handles are comfortable to hold, and makes using these saws easier. Hole in handle is for hanging the tool when not in use.

720-6510 .....Green Wood Saw 120 m  
720-6520 ..... Fine Cutting Saw 120 mm  
720-6530 ..... Keyhole Saw 105 mm

Razor Saws

These saws all share some basic design elements that make them a pleasure to use -- overall length of about 18" and a fantastic, comfortable, contoured plastic grip. All are modern variations of the traditional Japanese pull-stroke saw and each fills a specific need in the shop. Small kerfs and accurate cuts will result from the quality, balance, and design of these saws. Replaceable blades makes the maintenance of the saws very easy.



Use this dozuki saw for small joinery in most woods. Cuts a thin and straight kerf. Blade has seventeen teeth per inch.

770-3500 .....Dozuki with 0.3mm blade  
770-3510 .....Dozuki 0.3mm Blade Only

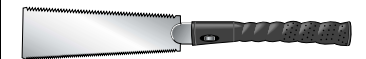

Perfect for cross cutting or ripping of smaller stock. Blade has seventeen teeth per inch on the cross cutting side and six teeth per inch on the rip side.

770-3600 .....Ryoba 0.5mm blade  
770-3610 .....Ryoba 0.5mm Blade Only



Craft saw that is perfect for cutting plastics and hardwoods. Blade has seventeen teeth per inch.

770-3700 .....Craft Saw 0.3mm blade  
770-3710 .....Blade Only

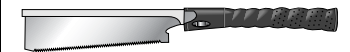

Excellent saw for the very finest cutting of small pieces of wood. Intricate joinery is possible with this twenty-five teeth per inch blade.

770-3800 .....Very Fine 0.3mm blade  
770-3810 .....Blade Only

Beading Saw



Beading saw of traditional Japanese saw design makes finest cuts.

720-2900 ..... Beading Saw





SAWS

Coping Saw Frames

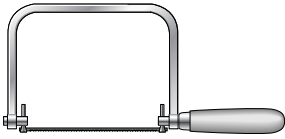

Blade can be adjusted to any angle, providing the best approach to your work. The tension is adjusted by means of turning the handle, and the saw frame accepts standard coping saw blades with pins. A quality tool that will last for many years. Blades for both metal and wood can be found below. This nicely made tool is from Germany.

540-2000 ..... Coping Saw Frame

Coping Saw Blades



High quality coping saw blades with pinned ends. Fits our 540-2000 coping saw. Made in Germany.

540-7500 ..... 12 Blades for Wood  
540-7550 ..... 12 Blades for Metal

Jeweler's Saw Frame

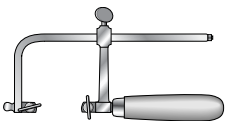

Solidly made saw frame with wooden handle. Broken saw blades can be accommodated by means of the back adjustment. The saw blades below are designed to be used with this frame. Made in Germany.

540-4000 ..... Jewelers Saw - Adjustable

Jeweler's Saw Blades



Top quality hardened saw blades for precision work in cutting gold, silver, bronze, and other precious metals. Blade length is 130 mm. Reference #0 is the larger blade in the selection while reference #8/0 is the finest blade of the selection. Use these blades in our jeweler's saw frame 540-4000. Package of twelve blades. Made in Germany.

Teeth Per Inch	Ref #
830-4003 ..... 55.9	0
830-4203 ..... 61.0	2/0
830-4303 ..... 66.0	3/0
830-4403 ..... 71.1	4/0
830-4503 ..... 76.2	5/0
830-4603 ..... 81.3	6/0
830-4703 ..... 86.4	7/0

Quality Tools

Fret Saw Frame



Quality fretsaw frame for accurate fretwork, marquetry, or other intricate and detailed work in thin material. Blades are securely held by clamps on each end. One of the easiest ways to hold your work while using a fretsaw is to clamp one of our fretsaw boards (also on this page) on your bench. Place the work on top of the board and use the saw in a vertical motion. Has a wooden handle. Made in Germany.

540-1000 ..... Fretsaw

Fret Saw Blades



This is a popular and useful style of blade. Perfect for use in the fretsaw frames shown on this page. The teeth are designed for cutting wood, and are hardened for long life. Blade length is 130 mm. The smaller reference number (#0) is the finer blade, while the larger reference number (#12) is the biggest blade in the selection. These blades can also be used in a fretsaw machine. Package of twelve blades. Made in Germany.

Teeth per Inch	Ref #
830-1003 ..... 27.0	#0
830-1013 ..... 25.0	#1
830-1023 ..... 22.5	#2
830-1033 ..... 20.0	#3
830-1043 ..... 18.0	#4
830-1053 ..... 17.0	#5
830-1063 ..... 16.0	#6
830-1083 ..... 14.0	#8
830-1103 ..... 12.0	#10
830-1123 ..... 9.5	#12

Fretsaw Boards

Clamp one of these fretsaw boards on your bench then place the work on top of the board and use the saw in a vertical motion.

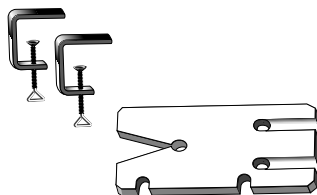

This fretsaw board makes use of two clamps for secure fastening to the bench. Made in Germany.

540-4750 ..... Board with two clamps

Junior Saws

These saws are meant for all-around use in the shop and in the home. Whichever model you choose, you will find a multitude of uses for it. The blades are designed to cut metal, wood, and plastics. High quality German product.



540-3100 ..... Wire Frame



540-3200 ..... Wood Handle

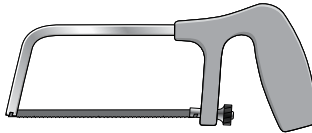

540-3300 ..... Plastic Handle

Junior Saw Blades



Package of junior saw blades to fit all saw frames above. Choose between blades for metal or wood. Made in Germany.

540-8550 ..... 12 Blades for Metal  
540-8500 ..... 12 Blades for Wood

Craft Saws

These fine saws cut an amazingly fine, small kerf. Useful in many craft activities and small joinery; excellent for the musical instrument builder. Blades are six and one-half inches long. Interchangeable model comes with three blades that fit the same handle! USA.



255-3000 ...015" kerf ... 24 tpi 7/8" depth



255-5000 ...010" kerf ... 32 tpi 13/16" depth

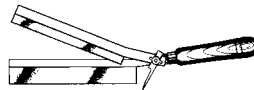

255-1000 ..... Interchangeable Blade Saw

Hand Saws

These handsaws are professional tools manufactured from the finest Sheffield steel. Milled teeth are specially hardened for lasting use, skew shape with polished hardwood handle which is set with three brass plated screws. Tenon saw is brass backed which provides greater stability in use. Made in England.



645-2500 ..... 20" x 10 tpi ..... Crosscut Saw



645-3500 ..... 26" x 8 tpi ..... Crosscut Saw



645-4500 ..... 26" x 5 tpi ..... Rip Saw



645-6050 ..... 12" ..... Brass Back Tenon Saw

Shark Teeth Hand Saw

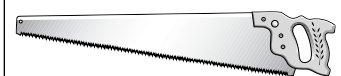

Hand saw has special Japanese "Edo-me" (shark) teeth for extra fast cutting. Teeth are designed so that the cutting action occurs both on the push and the pull stroke. If you are used to a traditional Western style saw, you will feel at home with this tool, and get your work done faster as well! Made in Japan.

740-5726 ..... 26" Saw 10 tpi

Blade-Gard

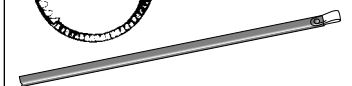
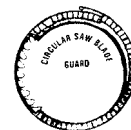

Nothing is so frustrating as having a newly-sharpened saw get accidentally damaged. With Blade-Gard your hand and circular saw blades are protected the moment you snap them on. Hand saw guard for saws up to 26" and circular saw guard for blades to 10".

150-5000 ..... Hand Saw Guard  
150-6000 ..... Circular Saw Guard





SAWS

Folding Carpenter Saw



This is a great saw for your toolbox! If you have occasional use for a hand saw -- and like the great results you get with a Japanese style blade and handle -- this is perfect for you. The wooden handle protects the teeth from accidental damage. Made in Japan.

720-6750 ..... Folding Carpenter Saw  
720-6755 ..... Blade Only

Saw Files

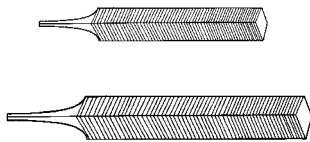

These 'feather edge' files are essential for maintaining the cutting edge of Japanese saws. Two sizes are available.

740-1010 ..... 3"  
740-1030 ..... 4"

Saw Set

Proper alignment of handsaws is a must. With the aid of a few tools, handsaws can be kept sharp. Once the saw teeth are filed sharp, the saw set is then used to reset the teeth. Smaller tool sets blades up to 1.5mm thick and the larger to 2.5mm thick. It can also set steel circular saw blades. Made in Germany.



580-6400 ..... Saw Set 180mm Long



580-6500 ..... Saw Set 210mm Long

rlc200906

Brass Back Tenon Saw

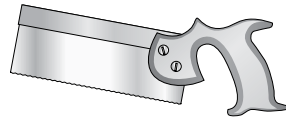

Two finely made tenon saws. Both have brass backs to provide a rigid blade and stability while cutting. The open style handle is comfortable to hold and use, allowing for the greatest degree of control in cutting a wide variety of joints. Made in France.

840-1050 ..... Brass Back 12" Open Handle  
840-1100 ..... Brass Back 8" Open Handle

Flush Cutting Saw

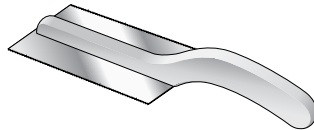

Cut flush to the surface of wood. Perfect for cutting off the ends of protruding plugs. The nicely shaped wooden handle is arched to allow your hand plenty of room underneath. Both sides of the blade are toothed to allow both left and right cutting. Made in France.

840-1250 ..... Flush Cutting Saw

Turning Saw

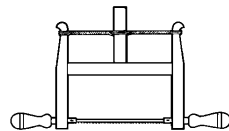

High quality, traditionally designed turning saw. Nicely finished beechwood parts along with a finely made blade. Wonderful tool to look at, and even better to use! Made in England.

620-6000 ..... 12" Bladed Turning Saw  
620-6050 ..... Replacement Blade Only

Span Web Saw

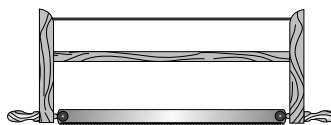

Span web saw. Wire stretching, set and sharpened. Blade length just under 24". Comes with the 1/2" wide blade. Made in Germany.

562-2000 ..... Span Web Saw  
562-2005 ..... 1/2" Blade only

1-800-356-2195 • www.rlarson.com

Brass Back Dovetail Saws

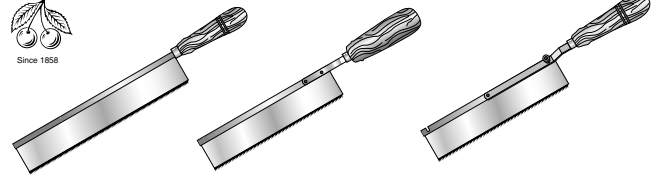

The stiffening back is made out of brass to add guiding weight and aesthetic joy. Highest quality German tool with 15 teeth per inch. Two Cherries

520-6020 ..... 10" ..... Dovetail  
520-6050 ..... 10" ..... Offset Dovetail  
520-6080 ..... 10" ..... Reversible Dovetail

Dovetail Saws

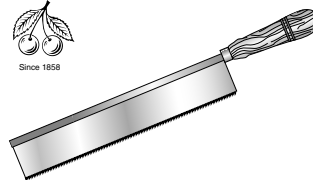

Steel backed dovetail saw of fine German workmanship. Straight, polished handle, set & sharpened. Saw is 250mm (9.6") long.

520-2020 ..... Dovetail ..... 15 tpi

Offset Dovetail Saws

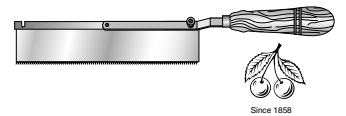

The finest German workmanship with polished cranked handle, set and sharpened teeth. Blade is offset to the steel stiffening back so flush cuts can be made (as in cutting off dowel pins, through mortises, etc.). Reversible handle styles allow greater access. Both saws are 250 mm (9.6") long. Two Cherries

520-2050 ..... Offset ..... 15 tpi  
520-2080 ..... Reversible ..... 15 tpi

Brass Back Razor Saw

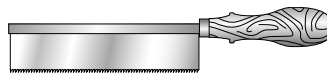

This is a perfect joint cutting saw for the woodworker who prefers a traditional European style saw. Finely turned beech wood finished handle with brass stiffening back makes this saw a pleasure to use. At 40 teeth per inch the saw will produce an exceptionally fine cut. Made in England.

645-1500 ..... Razor Back Saw

English Dovetail Saw

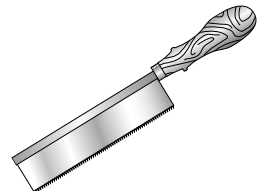

This 8" blade dovetail saw has a very fine nineteen teeth per inch configuration. With the premium high polished brass back, this saw makes cutting dovetails and other small joints a pleasure.

645-1000 ..... Dovetail Saw

Miter Box and Saw

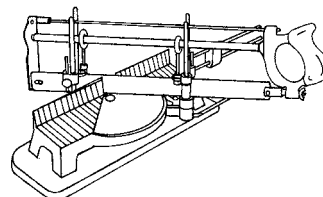

You can use this precision miter saw for cutting four, six, or eight angle frames and profiles in wood, alumi-

num, iron, or synthetic materials. The table is pressure cast and the four guide rods guarantees exact and solid work. The saw is equipped with standard wood cutting blade. Replacement blades available.

800-2800 ..... Mitre Box and Saw  
800-2814 ..... Mitre Box Saw Blade 14 tpi  
800-2818 ..... Mitre Box Saw Blade 18 tpi  
800-2830 ..... Mitre Box Guide Rod— Steel  
800-2831 ..... Setting Deeply Saw Cut  
800-2832 ..... Long Clamp  
800-2833 ..... Short Clamp  
800-2834 ..... Saw Guide



VICES - CLAMPS

Quick Release Vice

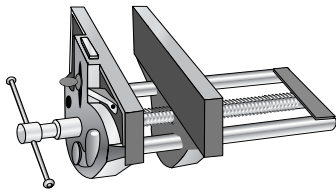

These efficient steel bench vises have time saving quick release mechanisms for the rapid movement of the vise jaw. Additionally, all have adjustable bench dogs. All models mount to the workbench edge and are fastened from underneath the bench. The 7 1/2" model requires approximately 12" of space under the bench and the 9" requires approximately 18". There are holes through the vise jaws so that they can be lined with wood faces. The 7 1/2" vise opens approximately 8" and the 9" vise opens approximately 13". Made in India by Anant.

- 896-5200 ..... 7 1/2" Wide Vise
- 896-5250 ..... 9" Wide Vise
- 896-5300 ..... 10 1/2" Wide Vise

Pinch Dogs

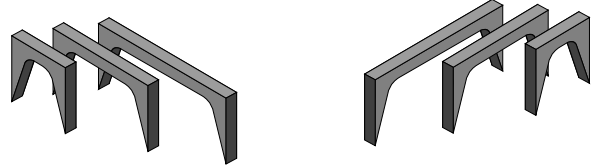

Pattern and cabinet maker steel pinch dogs. Square corners over the legs make for easy driving. Makes it a breeze to pull any two boards together. You will find endless uses for these reusable clamps . . . for instance if you are installing wainscoting in a room and need to pull together the boards. Use one pinch dog at the top and one at the bottom of the two pieces exactly where you will later install mould-

ing that will cover the small holes produced while using the pinch dogs. Keep a few of each size handy for those unexpected clamping needs.

- 160-3003 ..... 3/4"
- 160-3004 ..... 1"
- 160-3005 ..... 1 1/4"
- 160-3006 ..... 1 1/2"
- 160-3008 ..... 2"
- 160-3010 ..... 2 1/2"
- 160-3011 ..... 2 3/4"
- 160-3012 ..... 3"
- 160-3014 ..... 3 1/2"

Bench Stops

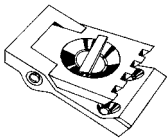

This bench stop will increase the size of materials that can be handled on your bench. Body is made aluminum to prevent damage to your tools.

- 800-1900 ..... Bench Stop

Bench Dogs



Two styles of bench dogs. The square dogs are 3/4" x 5/8" across and 6 3/4" long. The brass face on the square dog is 1" x 5/8". The round dogs are 3/4" in diameter and constructed of solid brass. Clamping face on the round dog is 1/4" x 1 1/16".

- 825-6325 ..... Round Bench Dogs (Pair)
- 825-6350 ..... Square Bench Dogs (Pair)

Pattern Maker's Vise

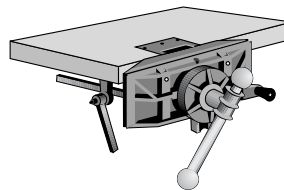

This vise can handle about any work holding job that you give it. The vise itself can rotate a full 360 degrees and the jaws pivot to accept tapered work. You can also swing the vise upwards to a horizontal position. The jaws are 13 3/4" wide and 5" deep. Comes with wood handle, instructions, and hardware.

- 825-1800 ..... Pattern Maker's Vise

Band Clamp

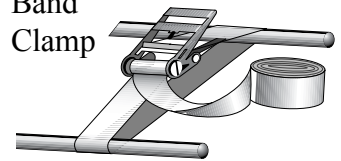

The one inch wide nylon web band is tightened by a ratcheting action that needs no tool to operate. The clamp can exert a pressure of 1500 pounds. You will find that this band clamp will easily help you in gluing up chairs, circular glue-ups for turnings, and other uneven clamping situations that bar clamps and other clamps will not handle.

- 825-1575 ..... 25' Band

Holdfast

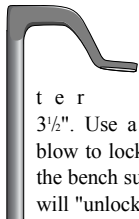

A cast iron holdfast with an 1 1/16" diameter post and a reach of 3 1/2". Use a mallet and a vertical blow to lock material tight against the bench surface. Sideways blows will "unlock" the holdfast.

- 800-3700 ..... Bench Holdfast

Wonders In Wood

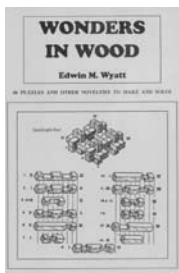

This is the sequel to the author's hugely popular "Puzzles in Wood". In this collection some 46 puzzles are just waiting to be made up and solved. They range from the simple to quite

challenging pieces for those craftsmen who like to take pride in having their work fit snugly and accurately. The three dimension jigsaw puzzle makes a great variation on the conventional jigsaw. Try squaring triangles or making a triple dovetail puzzle, or an eighteen piece double-cross. Happy puzzling.

- 415-1430 ..... Wonders In Wood

Surface Clamp

veritas®



Fast-acting surface clamp can be used anywhere you can drill a 3/4" hole. Can be used in material as thin as 5/8" so that it is ideal for use in jigs and fixtures. Precision machined from brass, steel, and anodized aluminum.

- 860-8600 ..... Surface Clap

Bench Dogs

veritas®

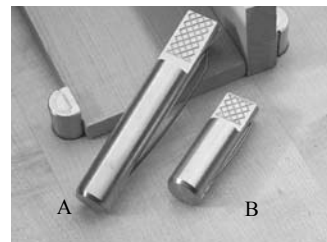

Smoothly ground dogs of excellent quality. Round in shape, style A is 4 3/8" long and 3/4" in diameter. Style B "Pups" are 2 3/8" long and are great for benches with tops up to 1 1/2" thick. They are also the perfect thing for use in bench sides; just drill holes in the skirt or edge of the top.

- 860-2070 ..... A ..... Round
- 860-2050 ..... B ..... "Pup"

Veritas Wonder Dog

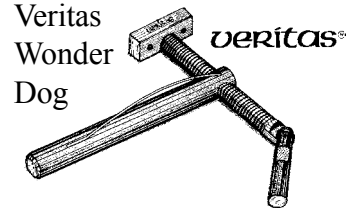

With a standard 3/4" diameter shank, these 6" long dogs can be used anywhere you can drill a 3/4" hole. Allows for a multitude of uses including long bar clamps, jigs, fixtures, and bench fittings.

- 860-2055 ..... Wonder Dog

Bench Hold Down



Clamp your work to your bench or anywhere else that a 3/4" hole can be drilled. Clamping capacity is 8" and throat capacity 8" as well.

- 860-8200 ..... Hold Down



MITREING TOOLS — PICTURE FRAMING TOOLS

Original German Mitre Cutter

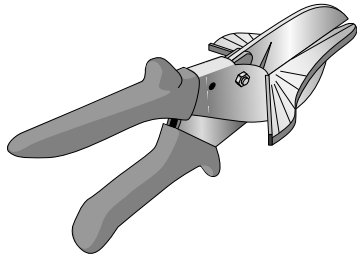

markings for cuts of fifteen degrees, thirty degrees, and ninety degrees. Similar to a garden shear, the built-in fence allows you to cut mitre joints quickly, easily, and with accuracy. Not only used by hobbyists, this tool has an essential place in many trades from finish carpenter to concrete former. Makes quick work of cutting shoe moulding and chamfer strip.

This is an essential tool for any woodworker or tradesman who needs to cut forty-five degree mitres in small mouldings on a regular basis. Base also has

- 815-1000 ..... Mitre Cutter
- 815-1025 ..... Compound Action Cutter
- 815-1050 ..... Replacement Blade
- 815-1060 ..... Replacement Base

The Original Mitre Clamps

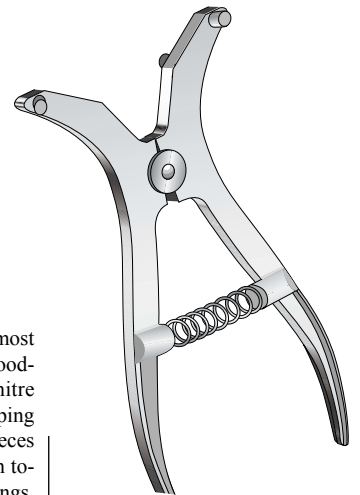
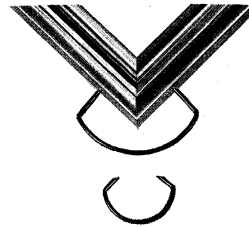

Mitred corners are one of the most difficult joints to clamp in all of wood-working. This very efficient mitre clamp system is like no other clamping method. It draws the two mitred pieces together and effectively holds them together with powerful spring-like rings. The rings have sharp points that do not drift or move once they are positioned. There are six ring sizes (A-F) for various sized workpieces. Ideal for picture frames, moulding, decorative trim and other mitre-type assemblies. The rings must be installed with the special application tool. Both sets come with application tool, and eight each of all ring sizes. Made in Germany.

	Mfg Nbr	Capacity
560-3130	Mitre Ring A	3/8" to 5/8"
560-3140	Mitre Ring B	5/8" to 1"
560-3150	Mitre Ring C	3/4" to 1 1/4"
560-3160	Mitre Ring D	1" to 1 3/4"
560-3170	Mitre Ring E	1 3/8" to 2 1/4"
560-3180	Mitre Ring F	2 1/2" to 3 1/2"
560-3100	Application Tool Only	
560-3190	Complete Kit	
560-3250	Kit In Wooden Box	
560-3275	Wood Box Only	

Mitre Trimmer

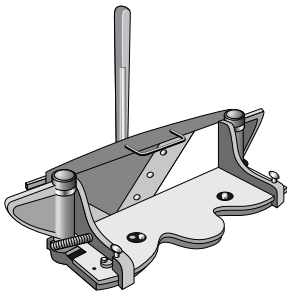

Miter trimmer makes perfect miters up to four inches, and when squaring stock up to six inches. Both right and left cuts can be made at angles between forty-five degrees and ninety degrees. The ground base surface and two razor-sharp knives offer controlled shaving and leave a glass smooth finish on the stock. This is the perfect tool for the picture framer, but is useful anywhere that a "perfect" mitre is necessary. Made in Taiwan.

- 800-3500 ..... Miter Trimmer
- 800-3510 ..... Pair of Blades Only
- 800-3525 ..... Left "Wing" Only
- 800-3530 ..... Right "Wing" Only

Frame Clamp

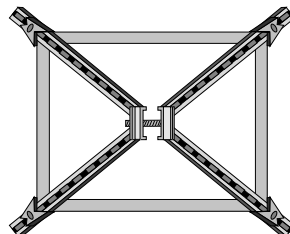

Quickly and accurately clamps a frame from 5" x 7" to 26" x 30". All four corners of the frame are clamped at one time, and equal pressure is applied to all joints. Aluminum railings with glue resistant plastic jaws.

- 800-2880 ..... Frame Clamp

Small Mitre Clamp Kit - The Original

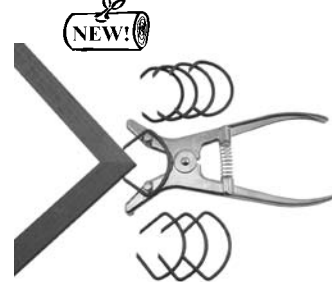

Made to meet the needs of carpenters, furniture restorers, boat builders, wood carvers and others with tricky clamping needs. It is ideal for securing mitred picture frames, crown moldings, corner baseboards, door and window casings and other finished and trim carpentry needs. The kit includes the same mitre clamp tool as shown above and is packaged with the most commonly used ring sizes. Kit comes with clamp tool and four each high-strength

spring steel B and D rings. With these two ring sizes molding widths from 5/8" to 1 3/4" can be clamped. Other ring sizes can be purchased separately.

- 560-3300 ..... Miter Clamp with Eight Rings

Mitre Vise

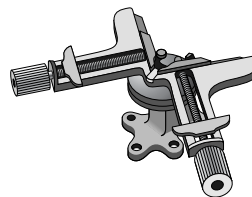

Clamps your work in position for perfect mitre joints. Vise tilts from 0 to 90 degrees, rotates 360 degrees, and has 4" jaw openings. Five holes in the base allows for secure mounting to the workbench.

- 800-3600 ..... Miter Vise

Picture Frame Brad Set

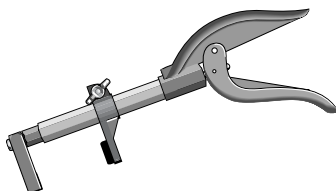

Installing those small nails on the backs of picture frames can be a laborious and frustrating job -- this tool takes care of it with ease. Position the nail where it is needed and squeeze it home with this clever tool.

- 190-1000 ..... Brad Set

Circular Work In Carpentry and Joinery

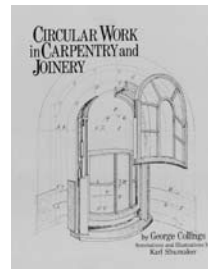

A practical guide on circular work of single and double curvature. This is a new edition of the 5th London edition of 1911.

Completely annotated with numerous new drawings. Essential for the carpenter and joiner.

- 415-1180 ..... Circular Work In Carpentry And Joinery

Mitre Clamps

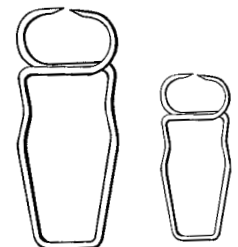

Open these clamps by squeezing with your fingers, then apply to mitre joint. Extremely handy. Use small for mouldings up to 5/8" and large up to 1". Made in Germany.

- 560-3050 ..... Small
- 560-3060 ..... Large





SANDING

Rubber Sanding Drums

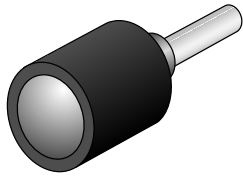

Solid rubber expanding drums; designed and balanced for maximum performance at high speeds (up to 2500 rpm). All have 1/4" shanks. Abrasive bands are aluminum oxide for long life. C is 50 grit (coarse), M - 80 grit (medium), and F - 120 grit (fine). Items included in set are marked (\*). Sizes indicate diameter and length.

Bands are packaged six per bag.

210-1000	1/2" x 1/2"	*Drum
210-1010	3/4" x 3/4"	Drum
210-1015	3/4" x 1"	*Drum
210-1020	1" x 1"	*Drum
210-1025	1 1/2" x 1 1/2"	*Drum
210-1030	2" x 1 1/2"	*Drum

275-1000	1/2" x 1/2"	*F-Band
275-1005	1/2" x 1/2"	M-Band
275-1010	1/2" x 1/2"	*C-Band
275-1011	3/4" x 3/4"	F-Band
275-1012	3/4" x 3/4"	M-Band
275-1013	3/4" x 3/4"	C-Band
275-0985	3/4" x 1"	*F-Band
275-0990	3/4" x 1"	M-Band
275-0995	3/4" x 1"	*C-Band
275-1015	1" x 1"	*F-Band
275-1020	1" x 1"	M-Band
275-1025	1" x 1"	*C-Band
275-1026	1 1/2" x 1 1/2"	*F-Band
275-1027	1 1/2" x 1 1/2"	M-Band
275-1028	1 1/2" x 1 1/2"	*C-Band
275-1030	2" x 1 1/2"	*F-Band
275-1035	2" x 1 1/2"	M-Band
275-1040	2" x 1 1/2"	*C-Band
210-0900	15pc Set Drum & Bands	

Deep Sanding Drums

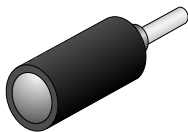

Same quality sanding drums as above yet deeper. Kit contains one each drum of all sizes with a fine and coarse band for each size. Sizes indicate diameter and length.

Bands are packaged six per bag.

210-2008	1/2" x 2"	Drum
210-2012	3/4" x 2"	Drum
210-2016	1" x 2"	Drum
210-2024	1 1/2" x 2"	Drum

275-2110	1/2" x 2"	F-Band
275-2120	1/2" x 2"	M-Band
275-2130	1/2" x 2"	C-Band
275-2210	3/4" x 2"	F-Band
275-2220	3/4" x 2"	M-Band
275-2230	3/4" x 2"	C-Band
275-2310	1" x 2"	F-Band
275-2320	1" x 2"	M-Band
275-2330	1" x 2"	C-Band
275-2510	1 1/2" x 2"	F-Band
275-2520	1 1/2" x 2"	M-Band
275-2530	1 1/2" x 2"	C-Band
210-2900	Extra Deep ... Set/12 Pcs.	

Contour Sanding Set

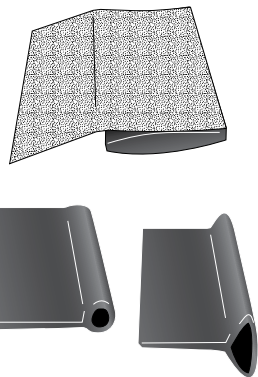

Ingenious sanding aids made of flexible rubber ideal for sanding curved, round or grooved shaped surfaces. To use, simply wrap standard sanding paper around the different profiles. Set of eight includes three sanding pads and five profiles.

825-6575 ..... Contour Sanding Set

Motor Driven Sanding Drum

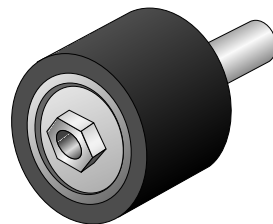

Use in drill chuck or directly onto 1/2" motor shaft or drill press. Quick change so that no adhesive is required. Three inch diameter by three inch width.

Bands are packaged six per bag.

210-2080	3" x 3"	Drum
275-2910	3" x 3"	F-Band
275-2920	3" x 3"	M-Band
275-2930	3" x 3"	C-Band

Abrasive Cleaner

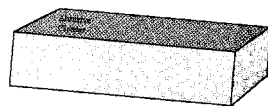

Two inexpensive abrasive cleaning blocks that will lower your abrasive budget the first time they are used. Essential for anyone using abrasives on power equipment.

222-2000	1 1/2" x 1 1/2" x 8"
222-5000	2" x 2" x 12"

Sleeveless Drum Sanders

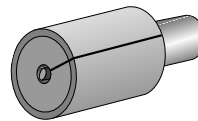

For use on drill press, lathe, electric drill, or small motor. What is more, there are no more sanding bands to purchase because this unique product accepts sandpaper from standard sheets available anywhere. A unique locking device secures both ends of the sandpaper (garnet paper is recommended) so replacing worn abrasive can be simple, easy, and inexpensive. Model 328-2000 comes with a 1/4" shank, all other drums have a 1/2" bore with setscrew and require the use of one of the arbors shown. Made in the USA.

328-2000	3/4" x 2 1/4"
328-3000	3/4" x 3"
328-3100	1" x 3"
328-3150	1 1/2" x 3"
328-3200	2" x 3"
328-3300	3" x 3"
328-6300	3" x 6"
328-1200	1/2" Shank Arbor
328-1300	3/8" Shank Arbor
328-1400	1/4" Shank Arbor

Sleeveless Sanding Drum Set

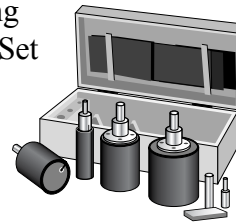

An economical set of sanding drums. Cut and fit sandpaper to the drum, lock it into place with the specially designed locking tube. Use in 1/2" motor arbors or in a drill press chuck. Drums are 3" in length and include diameters of 1", 2 1/8", 2 5/8", and 3 1/8". Also included are 1/4" and 1/2" shank adapters. Imported.

825-2150 ..... Sleeveless Sanding Drum Set

Double Density Sanding Block

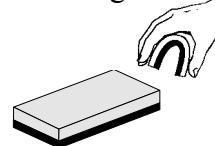

Use the soft and pliable gray side of the block for irregular surfaces, and the stiff black side for faster sanding on curved surfaces. Sandpaper sticks to this 2 1/2" x 5" x 5/8" block without adhesive.

268-3000 ..... Double Density

Cork Sanding Block

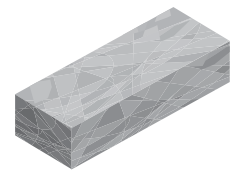

This sanding block is made of compressed cork with beveled edges. Inexpensive, and yet one of the most useful sanding blocks available. Can be carved to the shape of various mouldings with ease. Length of 4 3/8", width of 2 3/8", and thickness of 1 3/8".

560-5500 ..... Sanding Block

Sanding Block



The True-Flat sanding block (available in two sizes) is second to none. Comfortable in your hand, this must be the finest sanding block available today! Each block uses one-third sheet of standard sandpaper.

268-2500	5"
268-2900	9"

Sand-Eze Hand Sander

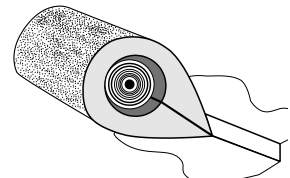

Unique shape allows the Sand-Eze to sand in corners and grooves of flat or contour surfaces. The inner body of the Sand-Eze holds a 2 1/2" wide sandpaper roll, or a strip of sandpaper can be used.

268-1700 ..... Sand-Eze Hand Sander

Tear-Drop Sander

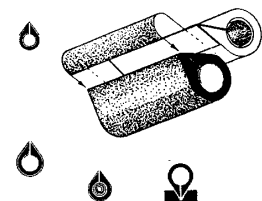

Another highly flexible sander that can conform to many surfaces. Easy to use with any abrasive paper cut in half to 5 1/2" x 9".

268-1500 ..... Tear-Drop





### Sanding Stick

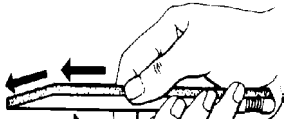

This great tool is available in three handy sizes, each holding a sanding belt that can be rotated for complete and economical use. Reach tough to get at areas on woodcarvings and other projects. Sizes available are 1/4" x 6", 1/2" x 8", and 3/4" x 10". Color coding by grit makes it easier to work from coarse to fine grits for the perfect finish.

- 80 Grit Gray Body Tool**
- 225-1008 ..... 1/4" x 6"
- 225-2008 ..... 1/2" x 8"
- 225-3008 ..... 3/4" x 10"
- 120 Grit Red Body Tool**
- 225-1012 ..... 1/4" x 6"
- 225-2012 ..... 1/2" x 8"
- 225-3012 ..... 3/4" x 10"
- 240 Grit Blue Body Tool**
- 225-1024 ..... 1/4" x 6"
- 225-2024 ..... 1/2" x 8"
- 225-3024 ..... 3/4" x 10"
- 320 Grit Green Body Tool**
- 225-1032 ..... 1/4" x 6"
- 225-2032 ..... 1/2" x 8"
- 225-3032 ..... 3/4" x 10"

- Replacement Sanding Belts (20 pieces)**
- |          | Grit | Size       |
|----------|------|------------|
| 225-5008 | 80   | 1/4" x 6"  |
| 225-6008 | 80   | 1/2" x 8"  |
| 225-7008 | 80   | 3/4" x 10" |
| 225-5012 | 120  | 1/4" x 6"  |
| 225-6012 | 120  | 1/2" x 8"  |
| 225-7012 | 120  | 3/4" x 10" |
| 225-5024 | 240  | 1/4" x 6"  |
| 225-6024 | 240  | 1/2" x 8"  |
| 225-7024 | 240  | 3/4" x 10" |
| 225-5032 | 320  | 1/4" x 6"  |
| 225-6032 | 320  | 1/2" x 8"  |
| 225-7032 | 320  | 3/4" x 10" |

### Round Sanding Block

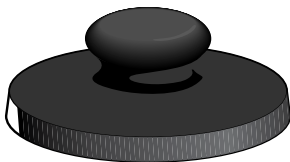

A comfortable sanding aid which allows use of the popular 6" circular, adhesive-backed disks. Simply peel and stick the sanding disk to the sanding block. It's ideal for sanding flat areas, such as, table tops and unattached shelves. Disk not included.

- 268-4000 ..... 6" Sanding Block

### Python File Handles



Python file handles are manufactured from the finest quality timber, and pressed inside the center of each handle is a steel spring, firmly secured and covered by a ferrule of special design. Together they take up all pressure when the file is driven in the handle. Use the file length indicated below as a guide only, as file tangs can vary. Made in England.

Number	Size	Fits File Length
610-1000	#0	3" to 6"
610-1100	#1	6" to 10"
610-1200	#2	10" to 14"
610-1300	#3	14" to 16"



### Universal Handle



Designed to firmly grip the tang of files, rasps and awls, this handle measures 4" long and has a tightening-loosening flat knob at the base of the handle which engages wedge-shaped grippers at the other end.

- 825-3650 ..... Universal Handle

### Chainsaw File



A handy file for touching up dull chain saw blades. Take with you to the job site and save time by keeping the chain saw blade at its best.

- 820-6000 ..... Chainsaw File 4mm (5/32")
- 820-6020 ..... Chainsaw File 4.8mm (5/16")
- 820-6040 ..... Chainsaw File 5.5mm (7/32")

### Horse Rasp

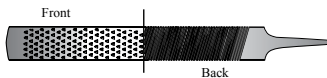

Sometimes referred to as a "Ferrier's Rasp". One side of the Horse Rasp has a rasp for coarser work and the opposite side has a file for smoother work. This 2 in 1 feature is very handy when working at the bench.

- 820-5500 ..... Horse Rasp

### Saw Files



High quality machine cut saw file. This selection should offer a file for virtually any typical Western hand saw.

- 555-1120 ..... 7" ..... Regular
- 555-1140 ..... 7" ..... Extra Slim
- 555-1160 ..... 6" ..... Extra Slim
- 555-1180 ..... 6" ..... Double Extra Slim
- 555-1190 ..... 5" ..... Extra Slim
- 555-1200 ..... 4" ..... Extra Slim
- 555-1220 ..... 4" ..... Double Extra Slim

### Mill Files



Single-cut mill files are used by the woodworker in sharpening both the saw and cabinet scraper. Very high quality machine cut tool.

- 555-1000 ..... 6" Second Cut
- 555-1010 ..... 8" Second Cut
- 555-1020 ..... 10" Second Cut

### Arts And Crafts Furniture: Projects

Fifteen projects for the woodworker.

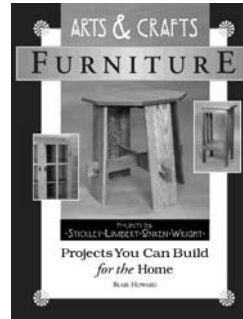

These projects represent the work of not only the most famous members of the movement but also of such designers as Oscar Onken and Charles Limbert, whose works are not commonly presented in other woodworking project books. Includes step-by-step instructions, joinery, measured drawings, fumed oak process, and bills of material. Projects include a print stand by Frank Lloyd Wright, book stand by Oscar Onken, Book Case by Limbert, a writing desk by G. Stickley and more.

- 415-1460 ..... Arts And Crafts Furniture: Projects

### Hand Cut Rasps

These rasps are made to the highest level of quality. Hand cut by journeymen file and rasp makers, these rasps are made the original way in a small Austrian workshop. Far superior to typical machine made rasps, these are appreciated by all fine workers in wood, especially by patternmakers.

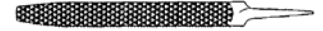

- 820-1500 ..... Cabinet Rasp 150mm Cut 5
- 820-1510 ..... Cabinet Rasp 200mm Cut 5
- 820-1520 ..... Cabinet Rasp 250mm Cut 5
- 820-1530 ..... Cabinet Rasp 300mm Cut 5

Not Illustrated

- 820-1610 ..... Hand Rasp 200mm Cut 5



- 820-1710 .. Half Round Rasp 200mm Cut 5

Not Illustrated

- 820-1810 ..... Round Rasp 200mm Cut 5

### Cabinet Files & Rasps



Essential for all woodworkers. We offer a broad selection of both cabinet files and cabinet rasps. These are quality machine cut tools, made in Austria.

- 555-1320 ..... 8" ..... Cabinet File
- 555-1340 ..... 10" ..... Cabinet File
- 555-1360 ..... 12" ..... Cabinet File
- 555-1520 ..... 6" ..... Round 2nd Cut
- 555-1540 ..... 8" ..... Round 2nd Cut
- 555-1560 ..... 10" ..... Round 2nd Cut
- 555-1620 ..... 8" ..... Cabinet Rasp Regular
- 555-1640 ..... 8" ..... Cabinet Rasp Smooth
- 555-1720 ..... 10" ..... Cabinet Rasp Regular
- 555-1740 ..... 10" ..... Cabinet Rasp Smooth
- 555-1820 ..... 12" ..... Cabinet Rasp Regular



- 820-1050 ..... Four Way Rasp+File 150mm

### File Cards

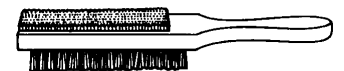

A file card is the answer to cleaning up a clogged file or rasp, making it an essential tool. This high quality file card has both a metal bristle card, and softer bristle brush.

- 297-3150 ..... Wood block with brush



FILES AND RASPS

Hand Cut Riffler Rasps

These specialty rasps are made to an exceptional level of quality. Hand cut by a journeyman file and rasp maker, these rasps are made in the original way in a small Austrian workshop. Sets in three sizes with the larger size tools being available individually. Fantastic quality!

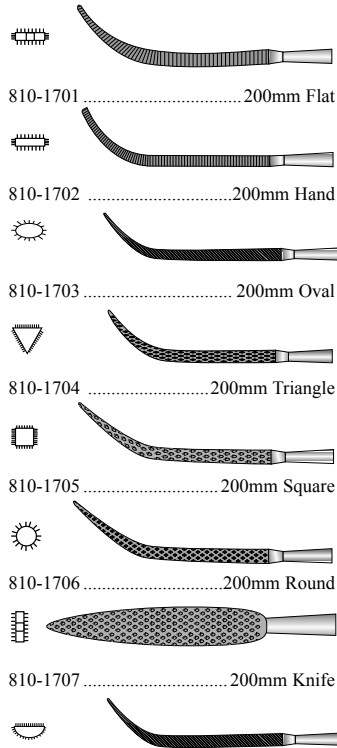

- 810-1701 ..... 200mm Flat
- 810-1702 ..... 200mm Hand
- 810-1703 ..... 200mm Oval
- 810-1704 ..... 200mm Triangle
- 810-1705 ..... 200mm Square
- 810-1706 ..... 200mm Round
- 810-1707 ..... 200mm Knife
- 810-1708 ..... 200mm Half Round
- 810-0460 ..... Set of Eight - 200mm

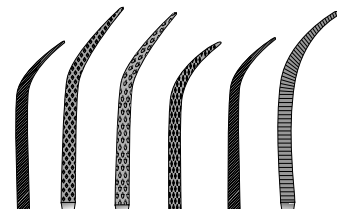
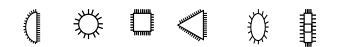

820-4000 ..... Set of Six - 180mm

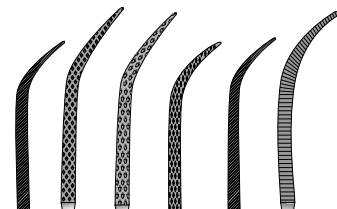
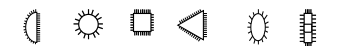

820-4500 ..... Set of Six - 150mm

Riffler Rasp Sets



An economical set of riffler rasps for the beginner or occasional carver. Set of eight riffler rasps are made in China.

825-3600 ..... Riffler Rasp Sets

Needle File Set

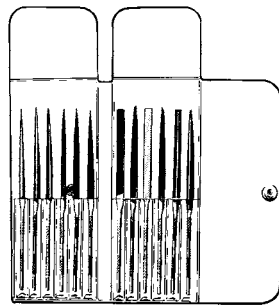

Needle file sets are in an assortment of twelve #0 cut needle files, in a plastic wallet. All files are 140mm in overall length and are machine cut. These files are made in Austria.

810-0405 ..... Set of 12

Sander/Rasp

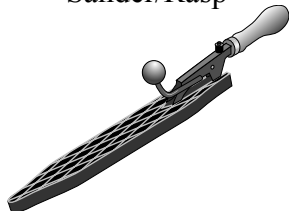

This unique shaping tool cuts like a rasp, but leaves a finish like that of a sanding tool. The adjustable style tool (illustrated) has a replaceable blade. Both tools feature fine and coarse teeth on opposite sides of the tool, and make quick work of any wood shaping and finishing job. Made in Japan.

- 745-0500 ..... Fixed Handle 11" x 1 1/16" blade
- 745-0000 ..... Adjustable Raised Handle
- 745-0001 ..... Blade Only for 745-0000

Riffler File-Rasps

Similar to the other riffler rasps found on this page, these quality rifflers are file-cut on one end, and rasp-cut on the other. Both sides of the tool have the same shape, so that you can rough shape with the rasp side, and immediately turn the tool around to finish with the file side. Hand cut in Austria, these riffler and file combinations are 210mm in overall length.

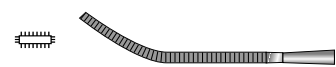

810-0751 ..... 210mm Flat

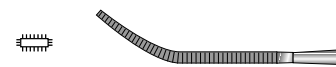

810-0752 ..... 210mm Hand



810-0753 ..... 210mm Square



810-0754 ..... 210mm Triangle



810-0755 ..... 210mm Round



810-0756 ..... 210mm Half Round

810-0760 ..... Set/6 Riffler Files-Rasps

Staircase Makers Rasp

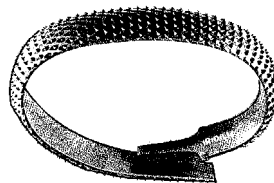

This tool was originally designed to assist the staircase-maker in his work, but has now found it's way into the woodcarvers tool box. Once you have this unique rasp available, you will not know how you got along without it! Size is the approximate circumference.

- 820-5050 ..... 150mm
- 820-5075 ..... 250mm

Needle Rasp Set

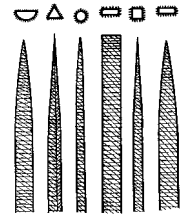

A set of six very useful needle rasps of assorted configurations. All are 140mm long and the set is packed in a plastic wallet. Made in Austria, these high quality needle rasps are cut by hand. Overall length of 140mm

810-0440 ..... Needle Rasp Set

Handy Rasp Set

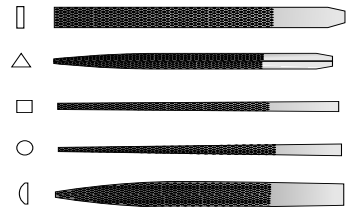

For heavier or larger work these square handled riffler rasps are just the tool. Slightly longer (215mm) than our other rifflers, these tools are made from heavier stock presenting a larger cutting surface. Hand cut, these rasps are made in Austria.

820-2000 ..... Set of Five

Riffler Rasp

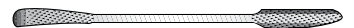

These two larger rifflers are hand cut and will prove extremely useful in carving and general woodworking applications. Overall length is ten inches, so these tools are larger than others found on this page. Hand cut in Austria.

- 820-5125 ..... Half-Round
- 820-5150 ..... Oval

Large Riffler Rasp

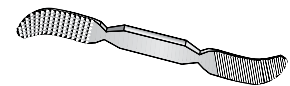

Similar to smaller riffler file-rasps, this single shape tool was originally designed for the staircase-maker. There are simply some jobs where size is important, and at 9 1/2" in length this tool will take care of those situations like nothing else will.

820-5025 ..... Stair Case Rasp



MALLETS — HAMMERS — BARS

Warrington Hammer



Cross-pein on one side lets you start small brads without injury to fingers. This traditional cabinetmakers hammer also makes it easy to pound a nail close to a vertical piece or in a tight corner. Made in England.

- 615-1175 .....4 oz.
- 615-1180 .....8 oz.
- 615-1190 .....10 oz.

Magnetic Brad Driver

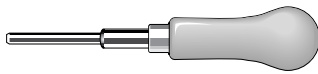

This magnetic brad driver starts, drives, and countersinks finishing nails, headless brads, and pins. Beechwood handle and brass barrel. Magnet holds the brad in the barrel while you position the tool. This is a must have for your shop, and you will be reaching for it more often than you might think!

- 620-0560 ..... Brad Driver

Nail Setter

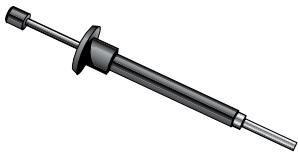

If you have ever tried to nail in a tight spot or in a place just a little too far to reach, this is the answer to those problems. Sturdily built tool has a magnetized rod that moves in the surrounding cylinder. Pull the rod back and place a nail in the cylinder then hit the rod with a hammer. Nailing has never been this easy before. Made in Japan.

- 775-4200 .....200 mm
- 775-4400 .....400 mm

Carpenter Hammers

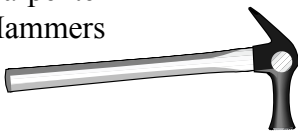

Dogyu Brand carpenter hammer from Japan is a uniquely balanced quality tool -- available in both smooth and waffle face. Give it a try, and you will not want to go back to your old style hammer. Magnetic version will hold a nail in a starting position, and with only one swing the nail is ready to drive home in the usual way!

- 775-2050 .....Waffle Face 16 oz.
- 775-3050 .....Magnetic Waffle Face 16 oz.
- 770-2000 .....Smooth Face 16 oz.

rlc200906

Carpenters' Mallet

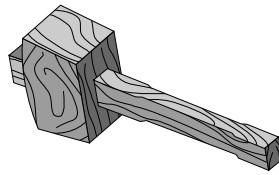

Carpenters' mallets of selected beechwood. Mortised heads and tapered handles of non-twist grip design, securely fitted. Made in England.

- 615-1210 .....Small
- 615-1220 .....Large

Dead Blow Mallet



This mallet provides the force you need with little or no damage to the surface of the material hit. The head is designed to be non-marring and is shot-filled to provide a solid, no bounce strike. Face of the mallet is 1 1/4" and the overall length is 10 1/2". Perfect for assembly work.

- 825-4975 ..... Dead Blow Mallet 14oz

Carpenters Hammer



This is a 20 oz. hammer which incorporates a uniquely designed magnetic nail holder. The nail is held in a groove atop the hammer's head thus permitting the user to hold the workpiece material with a free hand. The groove in the hammer head is slotted for both long and shorter nails, that is, nails from 2" up to 4" in length. Additionally, for better and more efficient leveraging while pulling out nails, the hammer features a shorter claw. Made with a rubber grip on a fiberglass handle. Made in Japan.

- 775-3060 .....20" Fiberglass Handle

3 in 1 Nail Setter Bar

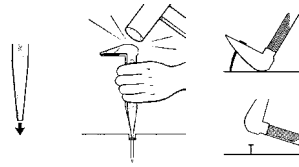

This handy bar is very similar to our "Cat's Paw" tool -- it can be used to pull nails, and as a lever for prying. In addition, the end of this versatile tool has a nail setting point. This feature will be invaluable for those doing remodeling work, in particular. Overall length of the tool is 160mm. Made in Japan.

- 745-5050 ..... Nail Setter Bar

Cat's Paw



Three very useful cats paw type bars with a wide prying edge. Perfect for restoration of furniture or homes where one must carefully remove pieces that need to be treated with extreme care. Made in Japan.

- 750-5075 .....150 mm
- 750-5100 .....200 mm
- 750-5125 .....250 mm

Mighty Bar

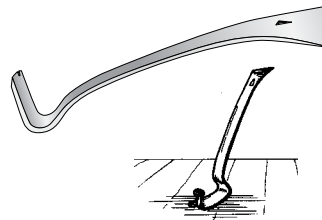

This is a very small bar, but when you need something of this size, it is indeed "mighty". This thin, yet strong tool, will be able to fit into the smallest opening to begin prying. Overall length of the tool is 190mm. Curved end is less pronounced than shown in illustration. Made in Japan.

- 745-4550 ..... Mighty Bar

Inches to Millimeters

Inch	Millimeters
1/32	0.8
1/16	1.6
1/8	3.2
3/16	4.8
1/4	6.4
5/16	7.9
3/8	9.5
7/16	11.1
1/2	12.7

Cat's Paw



The cat's paw is a small crowbar type tool for small work or tight places. This complete range of sizes is of the finest quality, and have very nicely finished ends to help in accomplishing delicate work. If you have not tried one of these handy tools before, try only one and you will likely see a need to own the entire range. Made in Japan.

Number	Approximate Length
745-2010	160mm
745-2020	210mm
745-2040	250mm
745-2060	280mm
745-2070	300mm

Tack Lifter

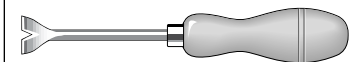

High quality tack lifter with clear finished beechwood handle. Great for re-upholstery work, or wherever small nails must be removed. Made in England

- 605-5200 .....Tack Lifter

Carpenter's Nippers



The quickest and easiest way to remove small nails and brads! Hot forged alloy steel for strength, broached jaws, induction hardened cutting edge. Fully machined face minimizes damage to the work surface. Stanley

- 660-6150 .....8 1/4" Nippers

Quality Tools





FINISHING

Painters' Tools

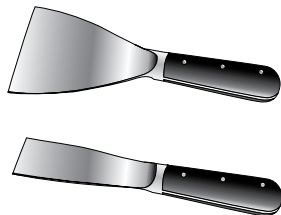

These highest quality painters' tools are made of special spring tempered blades (Sheffield steel) and are the finest tools for craftsman and hobbyist alike. Blade is one piece through the entire length of the tool, with hardwood riveted to the sides to form the handle.

- 615-2110 ..... 1" Stiff Blade
- 615-2130 ..... 2" Stiff Blade
- 615-2150 ..... 3" Stiff Blade

Glue Scraper

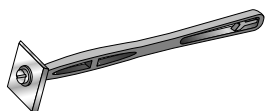

Heavy duty tool designed to make life just a little easier. Blade is high quality steel. Cleaning up a glue joint will not be a problem again. Kunz

- 580-2175 ..... Glue Scraper
- 580-2176 ..... Blade Only

Bees Wax Polish



Cream polish that is delightful and safe to use. Architectural Digest said, "There's a polish made by a beekeeper in British Columbia . . . this particular formula is outstanding".

- 870-2002 ..... Bees Wax Polish 2oz
- 870-2008 ..... Bees Wax Polish 7oz

Salad Bowl Finish



Oil and wax finish for salad and fruit bowls, butcher's blocks and cutting boards. Two sizes available.

- 870-3002 ..... Salad Bowl Finish 2oz
- 870-3008 ..... Salad Bowl Finish 8oz

Shavehook Set

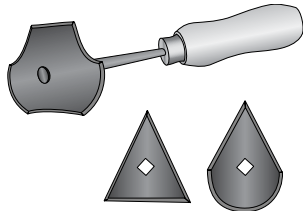

This shavehook, or moulding scraper, is ideal for a variety of tasks, including touching-up moulding shapes and restoration projects. The set comes with three replaceable scraping blades (combination, triangular, and teardrop). This tool is terrific for working in corners and tight spots. Beautifully made of tempered steel with a sturdy shank and a beech handle. Overall length of 9 1/2". Made in Germany.

- 620-1450 ..... Shavehook Set

Triangular Shavehook

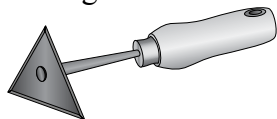

Triangular shavehook can be used for heavy duty scraping, but small and light enough that you will find many other uses for it as well.

- 620-1420 ..... Triangular

Shellac

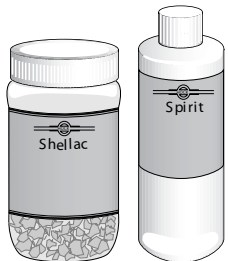

Among traditional wood finishers, dewaxed shellac is preferred as the best protection for fine wood surfaces. Shellac flakes are dissolved in "spirit", simple denatured alcohol, to make a finish that is considerably more "shop friendly" than other, petroleum-based finishes. A shellac finish becomes hard, durable, non-yellowing, and easy to repair. And it's nontoxic. "Orange" and "Blonde" colors of shellac allow subtle tinting. As mixed shellac ages, its water-resistance decreases and its drying time increases. Since you mix Hock Shellac yourself you are assured the freshest and most durable shellac available. The shellac kit includes solvent.

- 110-9100 ..... Shellac Kit - 10 oz Orange
- 110-9200 ..... Shellac Kit - 10 oz Blonde
- 110-9330 ..... Blonde Shellac Flakes (1 lb)
- 110-9340 ..... Orange Shellac Flakes (1 lb)
- 110-9350 ..... Garnet Shellac Flakes (1 lb)

Double Curved Varnish and Paint Brushes



These high quality hand-made brushes are ideal for applying varnish and other oil based finishes. They feature bristles made of 100% pig silk (hog bristle) and they are completely filled, without any filler bristles or stuffer, thereby allowing more finish to be taken up, longer brush strokes, and fewer trips back to the container to get more finish on the brush! They are hand-trimmed for proper shape and function. Their curved shape means that varnish flows out in the center of brush thus minimizing lap marks. Wood handles (cherry color) have all-galvanized steel ferrules. Available in three sizes: 1", 2" and 3" (25, 50 and 80mm). Made in France.

- 839-1125 ..... 25mm Brush
- 839-1150 ..... 50mm Brush
- 839-1175 ..... 80mm Brush



Constructed in a similar manner to the other brushes except these are made for water-based products, such as, Latex paint. To facilitate paint flow, these are 50% pig silk and 50% artificial bristles. Handles are natural color as opposed to the brushes for oil base materials which are cherry color. Available in three sizes: 1", 2" and 3" (25, 50 and 80mm).

- 839-1525 ..... 25mm Brush
- 839-1550 ..... 50mm Brush
- 839-1575 ..... 80mm Brush

String Wrapped Glue Brushes



Made to exacting age-old standards by a renowned European company, these hand assembled glue brushes can be used to apply hide (animal or fish) glue and standard shop glues. Hand wrapped cord is used, instead of a metal ferrule, so that there's no danger of metal contamination, oxidation and staining. Bristles are 100% pig silk (hog bristle). Made in France.

- 839-4025 ..... Ref. #4
- 839-4050 ..... Ref. #10
- 839-4075 ..... Ref. #3Plus

Cutting in Brushes



High quality brushes designed for oil based materials. Made of 100% pig silk (hog bristle) and featuring turned wood handles and copper ferrules. This traditional design is the best for cutting in work, the brush heads are formed to a point so that detail work and working in corners is unbelievably easy. The brush can be rolled during the stroke, allowing a maximum amount of material to be applied. These brushes are 100% natural chinese white pig silk and they are completely filled, without any filler bristles or stuffer, thereby allowing more finish to be taken up, longer brush strokes, and fewer trips back to the container to get more finish on the brush! The larger sizes are reinforced with thin cord. With care these brushes will last for years. Available in three sizes. Made in France.

- 839-2025 ..... 15mm Diameter
- 839-2050 ..... 19mm Diameter
- 839-2075 ..... 23mm Diameter



High quality hand-made cutting in brushes designed for latex based materials. To facilitate paint flow, these are 50% pig silk and 50% artificial bristles. This traditional design is the best for cutting in work. They have natural wood handles, copper ferrules and the larger sizes are also tied with thin cord for additional strength. They are marked for water/acrylic usage. Available in three sizes.

- 839-3025 ..... 15mm Diameter
- 839-3050 ..... 19mm Diameter
- 839-3075 ..... 23mm Diameter

Paint Removal Brushes

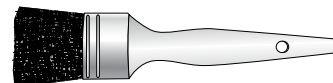

Made for delicate finish work and features a wooden handle and brush with bronze filling. It is approximately 1 1/4" (30mm) in width.

- 839-4525 ..... 30mm

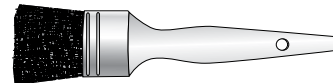

Made for vigorous work and features a wooden handle and brush with stainless filling. It is approximately 1 1/2" (40mm) in width.

- 839-4550 ..... 40mm





### Glue Applicator

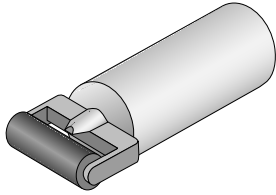

Fill the bottle with glue and you can easily apply a wide and even coat of adhesive. Application wheel is 2 3/8" wide and 1" in diameter. Bottle holds eight ounces of glue.

800-2855 ..... Glue Applicator

### Glue Injector

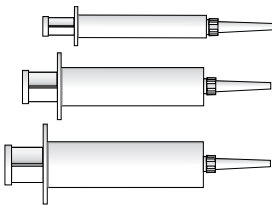

Plastic construction, these injectors can be used over and over again. Also useful for grease, oil, etc. Available in three different sizes, or in a set containing one of each. USA.

320-0500 ..... Five 6 cc Injectors  
320-1000 ..... Five 15cc Injectors  
320-1500 ..... Five 30 cc Injectors  
320-2000 ..... Set of Three

### Hide Glue



The real thing! Hide glues are the strongest and most versatile of animal glues. Traditional, standard preparation is exceedingly simple, just add water and mild heat. Mix only what you need.

152-1000 ..... 1 Pound Bag  
152-1100 ..... 2 Pound Bag  
152-1200 ..... 5 Pound Bag

### Bellows Glue Applicator

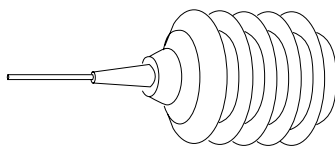

Designed for pinpoint gluing accuracy on detail work. One ounce bellows-style plastic body collapses with thumb pressure for easy glue control and placement. Stainless steel needle tip.

182-1000 ..... Glue Applicator

### Glue Bottle With Brush



This is the easy way to apply glue. Gives you complete control in where you apply the glue on your work. The bottle holds approximately eight ounces.

825-4300 ..... Glue Bottle with Brush

### Biscuit Slot Glue Bottle

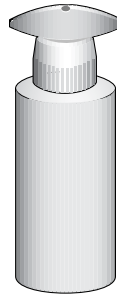

This glue bottle has a specially designed head that allows perfect application of glue into biscuit slots which makes the job quick and easy.

825-4400 ..... Biscuit Slot Glue Bottle

### Glue Spreader Set

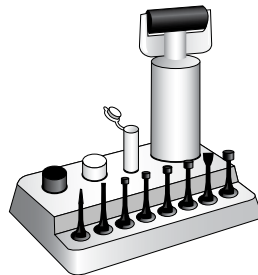

This kit gives you a complete gluing solution. The empty eight ounce bottle comes complete with a storage base block and a number of interchangeable heads (roller head, flat nozzle, pinpoint head, round head, five dowel heads). Includes wet well.

825-4375 ..... Glue Spreader Set

### Millimeters to Inches

Millimeters.....	Inches
1.....	0.039
2.....	0.078
3.....	0.118
4.....	0.157
5.....	0.196
6.....	0.236
7.....	0.275
8.....	0.314
9.....	0.353
10.....	0.393
20.....	0.787
30.....	1.181
40.....	1.574
50.....	1.968
60.....	2.362

### Power Tenon Cutter

veritas®



Designed for cutting tenons with shoulders in round workpieces. Available in eight cutting diameters, the smaller diameter cutters are ideal for building rustic furniture and the larger diameter cutters can be used for bed frames or fence rail to posts. Made of anodized aluminum and balanced for vibration-free usage. The cutters also have an integral bubble level for making more accurate cuts and they have a built-in honing guide for sharpening the blades on a drill press mounted drum sander. The Tenon Cutters are to be used with a hand held electric drill or a hand brace. Sizes 5/8" to 1" cut 2 3/4" long tenons and require a 3/8" or larger drill chuck. Sizes 1 1/4" to 2" cut 4 1/4" long tenons and require more torque to drive. They are for use in larger electric drills with a 1/2" or larger chuck.

860-5210 ..... 5/8"  
860-5212 ..... 3/4"  
860-5214 ..... 7/8"  
860-5216 ..... 1"  
860-5220 ..... 1 1/4"  
860-5224 ..... 1 1/2"  
860-5228 ..... 1 3/4"  
860-5232 ..... 2"  
860-5250 ..... Replacement Blade Only

### Mini Tenon Cutter

See Illustration Above

Designed for cutting tenons in smaller diameter workpieces, such as, chair rungs or trellis and lattice work. Available in six cutting diameters from 1/4" to 9/16". All sizes have straight blades which cut a 60° shoulder tenon. The 1/4", 5/16" and 3/8" sizes cut tenons up to 1" long and the 7/16", 1/2" and 9/16" sizes cut tenons up to 1 3/8" long. All sizes have a 3/8" shank diameter.

860-5404 ..... 1/4"  
860-5406 ..... 3/8"  
860-5408 ..... 1/2"  
860-5409 ..... 9/16"  
860-5410 ..... 5/16"  
860-5414 ..... 7/16"  
860-5450 ..... Replacement Blade Only

### Transfer Scribe

veritas®



Used for transferring the contours of one shape onto another, this scribe simplifies any number of jobs. Fully adjustable from 0" to 12". Includes a bidirectional compass and an extra-hard indelible pencil.

860-1300 ..... Transfer Scribe



These pencils will leave a mark or line longer than others - and require very little pressure in use.

860-4040 ..... Indelible Pencils (10)

### The Conversion And Seasoning Of Wood

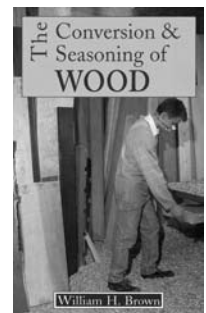

Covers the aspects of timber conversion from the most advantageous methods of cutting to produce the highest yield, to various methods of seasoning including air drying, kiln drying, dehumidification, etc. This work is directed towards the smaller timber merchant and landowner.

415-1500 ..... The Conversion And Seasoning Of Wood



TIMBER TOOLS

Froe

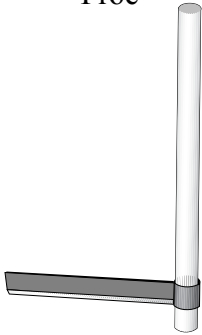

The traditional tool for splitting straight-grained wood, this froe is made to exacting standards in Germany. The entire length of the blade is carefully heat treated to provide an edge that will retain its sharpness in extended use.  
385-1000 ..... Froe

Spoon Bit



Used by chairmakers for boring or reaming holes in the seats and arms of chairs. Hand forged carbon steel. Hone on the inside cutting edge, never the outside edge. Clico, England  
635-5000 ..... Tapered Spoon Bit

Scorp

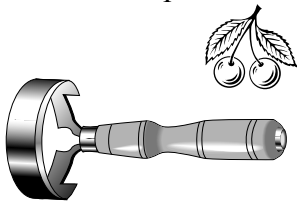

Scorp has a single handle, and smaller (3 1/2") diameter cutting shape and 1/4" blade width. Two Cherries  
500-2250 ..... Scorp

Inshave



Inshave, with two handles, has a blade width of 170mm. Excellent to cut deep hollows for bowls and chair seats. The blade is carefully forged, heat treated, and ground. Two Cherries  
500-2210 ..... Inshave

Adze

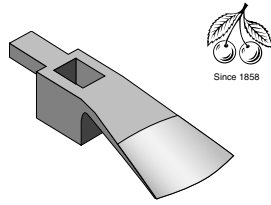

Two styles of adze are available. The flat lip adze has a cutting edge of just over 3", the curved lip adze just under 3". Both weigh approx. 2.5 pounds and come unhandled, order handle separately. Two Cherries

Blade Width	Style
500-1210 ..... 3 1/4"	Flat Edge
500-1250 ..... 2 1/2"	Curved Edge
500-1275 ..... 31"	Handle Only

Bark Spud

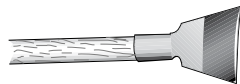

Made of high quality German steel and designed for stripping bark from logs for such things as timber frame construction or making posts. It features a hardened face side, an offset handle socket and a concave edge. Blade is 120mm wide, and the handle is approximately 48" in length.

598-1050 ..... Bark Spud (without handle)  
598-1000 ..... Bark Spud Handle ONLY

Two Man Saw



Traditional two man saw for cutting trees and larger timbers. Length of 1200mm. Blade is sharpened and set. Handles are included with the saw. Made in Germany.

562-3000 ..... Two Man Saw  
562-3500 ..... Pair of Handles Only

Timber & Log Saw



For use by one person, this timber and log saw has a comfortable plywood handle. Length is 800mm, and the blade is sharpened and set. Made in Germany.

562-4000 ..... Timber & Log Saw

Forged Drawknives

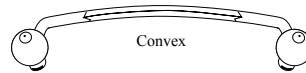
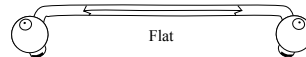

Nicely made drawknives are hot-forged and specially sharpened on felt wheels. Protective leather cases are included. The straight (flat) tool is available in three sizes and is useful on general work. The concave edge tool is good when you want to attack a slight hollow or when you want to attack very aggressively a problem area in a piece (a knot for example). The convex profile tool is good when you want to finish polish a curved area, example being a large rung, etc. Quality forged out of quality steel and well finished! Size indicated is the approximate length of the cutting edge, and the set is comprised of all three 150mm models. Made in France.

847-1500	Three 150mm Drawknives
847-1050	..... Flat 100mm Drawknife
847-1100	..... Flat 150mm Drawknife
847-1200	..... Convex 150mm Drawknife
847-1300	..... Concave 150mm Drawknife
847-1600	..... Flat 250mm Drawknife

Log Pick with Twisted Handle



The handle is twisted to be comfortably aligned for safely gripping and carrying logs or other wood objects up to 7" in diameter. It is especially useful for moving wet, slippery logs. Made of steel with soft durable handle grip in Austria.

823-3000 ..... Log Pick

Drawknives

Here is a selection of Two Cherries drawknives in curved and straight edge models. All tools are carefully made from high quality German steel.



500-1320 ..... 225mm Straight Edge



500-1350 ..... 140mm Curved Edge

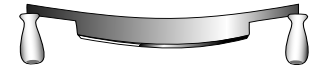

500-1370 ..... 225 Curved Edge



500-1395 ..... 300mm Curved Edge

Carver's Drawknife

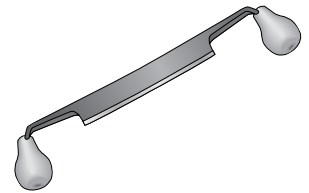

Smaller drawknife is perfect for wood-carving, but useful anywhere that space is tight. Ball-shaped handles are comfortable to grip, and allow adequate control. Made in France.

840-1350 ..... Drawknife 160mm (6 1/2")

Timber Framing Chisel



Heavy duty beveled and non-beveled timber framing chisels by Robert Sorby. Originally designed for North American log cabin building. Overall length about eighteen to twenty inches.

Beveled Chisel	Size	Handle Only
640-2016	..... 1"	..... 640-4102
640-2024	..... 1 1/2"	..... 640-4103
640-2032	..... 2"	..... 640-4103

Non-Beveled Chisel	Size
640-2116	..... 1"
640-2124	..... 1 1/2"
640-2132	..... 2"
640-4110	..... Replacement Handle Only



VENEERING TOOLS AND SUPPLIES

Intarsia Knife

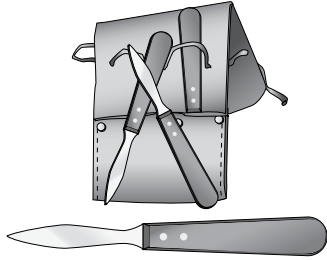

Intarsia takes exceptional skill and exceptional tools. These fine knives are designed for detailed, controlled usage, and hand comfort. The blades are razor sharp and feature blunt backs so that you can place your thumb against it for control and precise use. The set includes three knives — right hand bevel, left hand bevel, and double bevel. They have wood handles and come with a leather storage leather. In addition to their use for intarsia, they make great knives for carving. Made in France.

852-1000 ..... Trimming Knives In Case

**NEW!** Inlay Saw



A refined design of the typical veneer saw with a polished brass back and an ultra thin curved saw blade. Specifications: 3" blade, 20 TPI, 3/4" depth of cut, 0.010" blade thickness and 8 1/2" overall length. A high quality saw for the veneer enthusiast.

645-5000 ..... Inlay Saw

Veneer Hammer

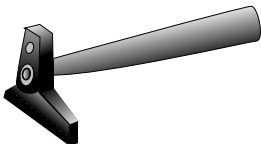

This is not a striking tool, but is used to smooth out the veneer surface. Made in Germany.

580-6100 ..... Veneer Hammer

Laminate Rollers

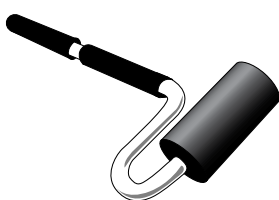

Two styles of laminate rollers to choose from. The "J" style roller (illustrated) is more traditional in design. The new and improved press roller exerts pressure more in line with the grip.

825-4325 ..... "J" Roller  
825-4350 ..... Press Roller

Veneer Cutter

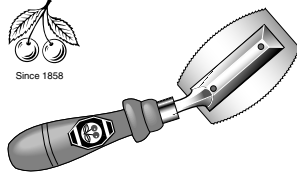

Veneer cutter with oval blade and offset handle. Cutting veneer with a knife leaves a beveled edge on the veneer cut whereas this tool makes a ninety degree cut of your veneer allowing a perfect joining of veneer pieces. Made in Germany.

520-2200 ..... Veneer Cutter  
520-2210 ..... Replacement Blade  
820-5100 ..... Sharpening File (Not Two Cherries)

Veneer Saw

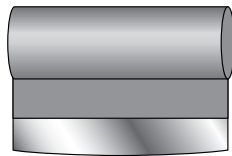

Traditional French veneer saw has a comfortable wooden handle and is gripped directly above the curved blade. This curved blade allows for a clean cut of your veneer. A quality tool made in France.

847-4000 ..... Veneer Saw

Japanese Veneer Saw

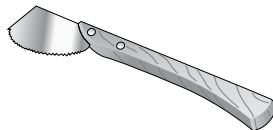

Here is a handy saw that is the perfect tool for cutting veneer. Rounded blade will also facilitate starting a cut in the middle of thin material.

720-2800 ..... 72mm Blade

"J" Roller

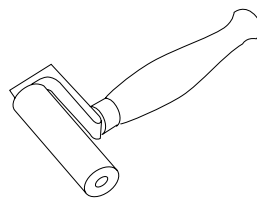

Designed for applying pressure on veneer and plastic laminates. Reaches into corners as roller has no axle projection on one end. Stainless roller never leaves marks on surfaces.

800-1710 ..... 40 mm ..... Small  
800-1720 ..... 90mm ..... Large

Edge Trimmer

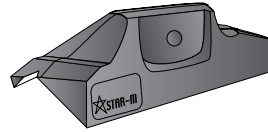

Designed to fit comfortably in the hand, this trimmer features two long lasting ceramic cutters, at either end, for both forward and backward usage. This tool trims excess edge material and leaves a chamfered profile. Approximately 3" in length.

776-1050 ..... Ceramic Edge/ Chamfer

Double Edge Trimmer

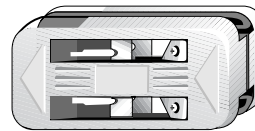

Simultaneously trim both sides of an edge-banded workpiece. It has hardened steel cutters and is adjustable within a range of 1/16" to 1/4".

825-6075 ..... Double Edge Trimmer

Trimming Tool



This inexpensive tool does a great job of trimming projecting plastic lipping edges. The blades have two cutting edges, and the tool works well for left or right-handers. Made in Germany.

575-1000 ..... Trimming Tool  
575-1005 ..... Spare Blade (5)

Veneer Tape

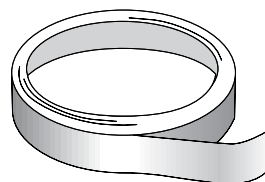

This solid tape (as opposed to punched tape with holes) is made specially for veneering. Very thin, and with a special adhesive that will readily sand off, leaving no residue. 3/4" x 650' per roll. Made in Germany.

290-1000 ..... 650'

Veneer Sheets & Edging

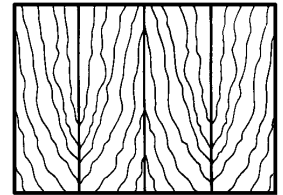
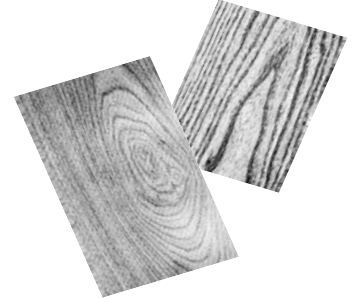

MATCHING VENEER IN PATTERNS

Each veneer pack contains five sheets (5" x 36") of natural wood. Perfect for furniture repairs, restorations, marquetry, game boards and much more. Available in 17 beautiful woods. Edge veneer is a perfect match to the sheets, and comes in rolls one inch wide by eight feet long.

5" x 36" Veneer Sheet

250-1010	..... Birch
250-1015	..... Cherry
250-1020	..... White Oak
250-1025	..... Rosewood
250-1030	..... Maple
250-1035	..... Pecan
250-1040	..... Pine
250-1045	..... Red Oak
250-1050	..... Ash
250-1055	..... Teak
250-1060	..... Walnut
250-1065	..... Birds Eye Maple
250-1070	..... Mahogany
250-1075	..... Stripe Mahogany
250-1080	..... Fiddle Makore
250-1085	..... Figured Anigre
250-1090	..... Mottled Makore

1" x 8' Veneer Edging

250-3010	..... Birch
250-3015	..... Cherry
250-3020	..... White Oak
250-3030	..... Maple
250-3035	..... Pecan
250-3040	..... Pine
250-3045	..... Red Oak
250-3050	..... Ash
250-3055	..... Teak
250-3060	..... Walnut
250-3065	..... Birds Eye Maple
250-3070	..... Mahogany
250-3080	..... Fiddle Makore
250-3085	..... Figured Anigre
250-3090	..... Mottled Makore
250-3095	..... Elm



POWER TOOL ACCESSORIES - JIG AND FIXTURE PARTS

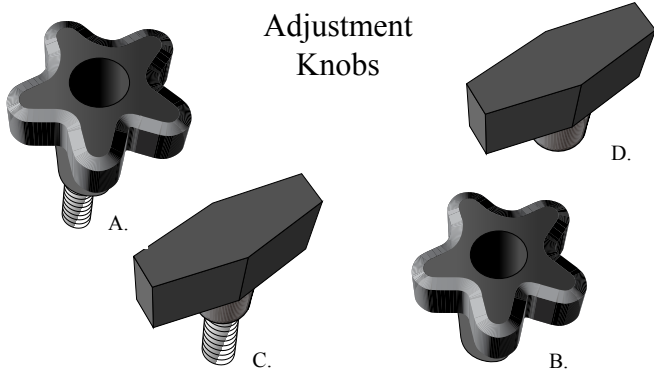

Adjustment Knobs

These adjustment knobs provide a wide variety of uses in any woodworking shop that will be making their own jigs and fixtures. Choose from a five point star or T knob depending upon the application and both knobs are available with stud or nut for a large range of design possibilities. Components are made of the highest grade materials and all metal parts are molded into the knob for the greatest possible strength as well. Made in the USA, prices for larger quantities upon request.

Pack of 5	Style	Size	Fitting
272-9010	A	2 5/16"	1/4-20 x 1" Stud
272-9020	A	2 5/16"	5/16-18 x 1" Stud
272-9030	A	2 5/16"	3/8-16 x 1" Stud
272-9040	B	2 5/16"	1/4-20 x 1" Thru Hole
272-9050	B	2 5/16"	5/16-18 x 1" Thru Hole
272-9060	B	2 5/16"	3/8-16 x 1" Thru Hole
272-9070	C	2"	1/4-20 x 1 1/4" Stud
272-9080	D	2"	1/4-20 Blind Insert
272-9090	D	2"	5/16-18 Blind Insert

Pack of 25	Style	Size	Fitting
272-9510	A	2 5/16"	1/4-20 x 1" Stud
272-9520	A	2 5/16"	5/16-18 x 1" Stud
272-9530	A	2 5/16"	3/8-16 x 1" Stud
272-9540	B	2 5/16"	1/4-20 x 1" Thru Hole
272-9550	B	2 5/16"	5/16-18 x 1" Thru Hole
272-9560	B	2 5/16"	3/8-16 x 1" Thru Hole
272-9570	C	2"	1/4-20 x 1 1/4" Stud
272-9580	D	2"	1/4-20 Blind Insert
272-9590	D	2"	5/16-18 Blind Insert

Ball Bearing Rollers

You will think of a multitude of uses for these handy ball bearing rollers. A common use would be to make your own infeed/outfeed table for table saws, finishing tables, and assembly lines. The 16mm (5/8") rollers will carry a 55 pound load and the 25mm (1") rollers a 77 pound load. Only your imagination will limit the uses you will find for these rollers.

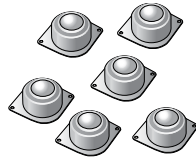

800-2725	Set of Six 5/8" Rollers
800-2735	Set of Six 1" Rollers

Router Mat

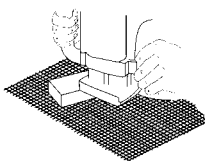

This friction router mat allows you to rout or sand small pieces of wood without clamps. Place the mat on the bench, work on the mat, then use your router or sander. The special urethane formula router mat lets you get work done with no extra fuss or bother. Mat size is two by four feet.

825-6200	2' x 4' Mat
----------	-------------

Slick Tape

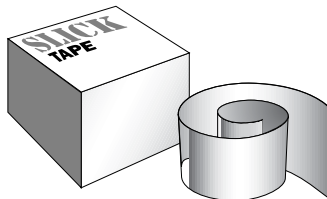

We call this slick tape, because it is really slick stuff! Your imagination will find a multitude of uses for this tape on fixtures, tool bases, drawer guides, etc. Both widths of slick tape are 1mm thick and 36" long.

825-1250	.3" Slick Tape
825-1275	.5/4" Slick Tape

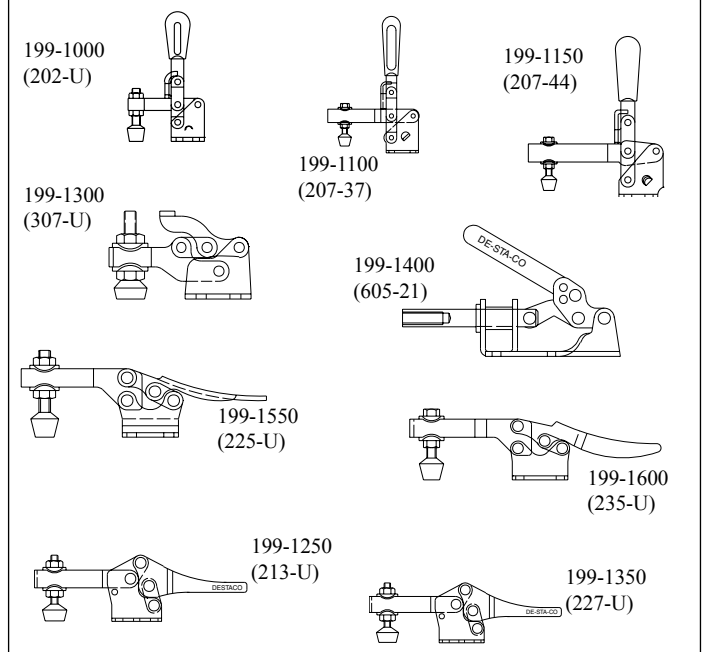

The hold-down clamps are easy to grab and activate quickly. Special versions of these include bar guides to provide extra lateral support and rigidity to hold-down clamps (indicated with lateral support in the chart below). The low silhouette clamps are useful for tight applications, and the flat top of the handle can be used to easily attach a straight piece of material to "gang" a number of clamps for simultaneous action. Your imagination will find a tremendous number of applications for the straight-line clamp. All clamps include a spindle.

Specification A indicates handle movement in degrees for hold down clamps and spindle travel for straight line clamps. Specification B indicates the bar opening in degrees for hold down clamps and internal spindle thread size for straight line models.

Number	Description	Model	A	B	Capacity
199-1000	Hold Down 1/4-20 Spindle	202-U	64°	104°	200 lbs
199-1100	Hold Down	207-37	62°	115°	375 lbs
199-1150	Hold Down Long Arm	207-44	62°	115°	375 lbs
199-1300	Hold Down Low	307-U	175°	92°	350 lbs
199-1400	Straight Line Push & Pull	605-21	1.25"	5/16-18	300 lbs
199-1550	Hold Down	225-U	70°	90°	500 lbs
199-1600	Hold Down	235-U	55°	90°	750 lbs
199-1250	Hold- Down with lateral support	213U	60°	90°	150 lbs
199-1350	Hold- Down with lateral support	227U	62°	92°	500 lbs

T-Track

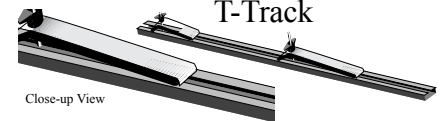

Fit this track in tool bases or into jigs and fixtures to save a tremendous amount of set-up time. Hold-down fits easily into the aluminum T-track and is secured by a knob. Track is available in three lengths and comes with hold-downs. Extra hold-downs are available as shown below. Imported.

Number	Track Length	Hold-Downs
825-3150	24" T-Track	2
825-3175	36" T-Track	3
825-3200	48" T-Track	4
825-3125	Extra Hold Down	





### Saw Step Gauge

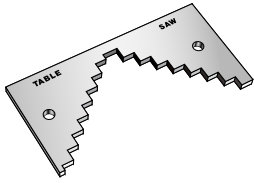

Makes accurate setup of table saws, radial arm saws, and other shop tools a quick and easy process. Gives an exact setting instantly!

825-3275 .....Saw Step Gauge

### Saw Setting Gauge



The beauty of this gauge is that it is a full 3/4" thick ensuring that teeth are being gauged at the top of the arc, and it can stand on its own. Will set precisely any height or width from 1/8" to 2" in 1/8" increments.

860-6010 .....Saw Setting Gauge

### Brass Bar Setup Gauges



You can keep the most commonly used measurements handy with this tool. Three precision machined brass bars (0.0003" tolerance). Gauges are 1/4" x 3/16", 1/2" x 1/16", and 3/8" x 1/8". You can even stack them together for additional sizes.

825-3250 ..... Brass Bar Setup Gauges

### Cutterhead Setting System

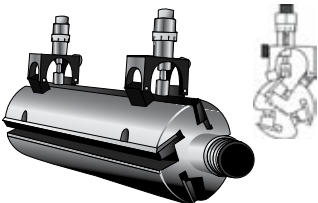

Simplify setting and adjusting knives in a cutterhead by stabilizing the knife blade. This system consists of two gauges each within a framework featuring strong magnets for firmly attaching to a cutterhead. Each of the adjustable gauge/frameworks also has a magnet for holding the knife. Simply place the gauge assembly over the knife and then adjust for the correct knife height. Both hands can then be used to tighten the cutterhead locking bar while the magnets hold the knife.

825-3550 ..... Cutterhead Setting System

### Bandsaw Blade File



This handy Bandsaw Blade File is used to smooth and round the back edge of a bandsaw blade. Roundness on a bandsaw's back edge allows radius cutting without the blade's back edge scoring into the just-cut wood. The handle is cross sectionally square so it's perpendicular to the blade when positioned on the bandsaw table and the handle length is so that the operator's hands are away from the moving bandsaw blade.

825-6025 .....Bandsaw Blade File

### Knife Hone & Holder

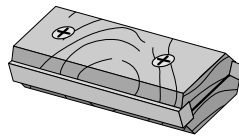

Allows you to hone your jointer and planer knives without removing them from the machine. One side has a 180 grit stone, while the other has a 400 grit stone.

800-1600 ..... Knife Hone & Holder

### Cutterhead Gauge

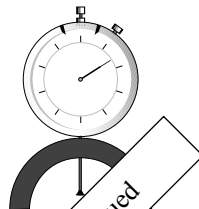

Adjusting the cutterhead on your tools can be extremely frustrating. Just when you think you have the correct adjustment, the knife moves as you tighten it. This cutterhead gauge makes this job much easier.

825-3525 ..... Cutterhead Gauge

### Inches to Millimeters

Inch	Millimeters
1/32	0.8
1/16	1.6
1/8	3.2
3/16	4.8
1/4	6.4
5/16	7.9
3/8	9.5
7/16	11.1
1/2	12.7

### Router Depth Gauge

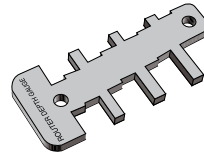

Quickly and accurately set your router to more than a dozen depth settings without the need for trial and error testing.

800-2100 ..... Router Depth Gauge

### Router Bit Centering Gauge



No need to worry where your router bit is going to cut using this nicely machined gauge. Fits 1/4" and 1/2" router. Overall the gauge is three inches long.

825-3350 ..... Router Bit Centering Gauge

### Router Bushing Set

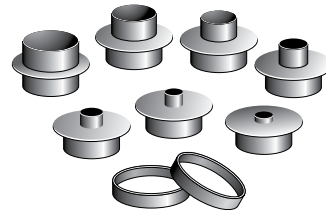

Brass template set will fit all Porter Cable routers or other routers that will accept a two piece template guide bushing. Set includes seven assorted template bushings plus two lock nuts in a plastic case.

825-2550 .....Brass Router Bushing Set

### Corner Chisel

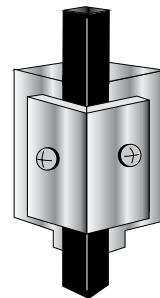

Use your router first to remove most of the material for a hinge mortise, then place this self-aligning chisel up against each mortise corner, and hammer the spring-loaded chisel shaft once to cut a perfect 90° corner for a perfect-fitting hinge plate. Cutting of 3/8" will work to a depth of 5/8".

800-1400 3/8" Corner Chisel



### Clico Hollow Mortise Chisel and Bit

Highest quality hollow square mortise chisels and bits, made in Sheffield England. This tool is made with a 5/8" diameter shank and an 8" overall length. Correct setting of the bit in the mortise chisel will ensure successful cutting of the tool and to ensure long life. Place the chisel



into its socket in the attachment. Put a coin about 1/16 inch between the face of the socket and the shoulder of the chisel to prevent the chisel being pushed fully home, tighten down screw to hold the chisel in place. Now fit the bit into the chuck and push it as far as possible into the chisel and secure. Slacken off the screw holding the chisel, remove the coin, push the chisel fully home again, and tighten the screw again. This method allows sufficient clearance for the bit to run smoothly in the chisel and begin to cut just ahead of the chisel.

635-7040 ..... 1/4" Chisel & Bit Set  
635-7050 ..... 5/16" Chisel & Bit Set  
635-7060 ..... 3/8" Chisel & Bit Set  
635-7080 ..... 1/2" Chisel & Bit Set

### Hollow Mortise Chisel Sharpener

Hollow chisel mortise chisel sharpening tool keeps the finest cutting edge.

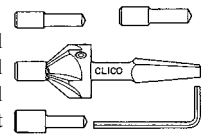

Place chisel in a vise, fit the tool (with proper size pilot installed) and a few turns of the tool produces a fine cutting edge. For the Clico hollow mortise chisel only.

635-9600 ..... Chisel Sharpener

### Wheel & Circle Cutter

This wheel (disc) and circle cutter is designed to give clean cut edges for both the hole and the cutout wheel. This is accomplished because the HSS cutter has two cutting edges. It also has a 1/2" pilot drill bit and is adjustable to cut wheels from 1" to 6" in diameter. Designed for use in a drill press at speeds no greater than 500 rpm. Used properly, it can also cut plastics and soft metals, such as copper or aluminum.

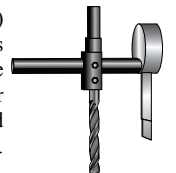

825-6510 ..... Wheel & Circle Cutter



**Bostik Lubricants**

**Top-Cote**

Top-Cote is the most sophisticated table top coating available. Use Top-Cote to seal metallic table tops and to protect tools against corrosion. Also minimizes friction, is anticorrosive and dries rapidly. 278-3105 ...Top-Cote ... Aerosol ..... 5.5 oz  
278-3110 ...Top-Cote ... Aerosol ..... 10.75 oz



**Dri-Cote**

Dri-Cote is rapidly becoming the woodworking industry standard for on-the-job coating of cutting tools. Reduces friction thereby lowering cutting temperatures and prolonging tool life. Heat resistant to 550 degrees Fahrenheit. 278-1110...Dri-Cote ... Aerosol ..... 10.75 oz



**Bearing Lubricant**

Bearing Lubricant is especially effective on router bit bearings or to lubricate slides and other high-load parts. 278-2500 ..... Bearing Lube Aerosol 5.5 oz



**Camilia Oil**



Long used in Japan as a rust preventative measure. Pump spray bottle for easy use. An alternative applicator is also available which allows you to daub the oil on the tool rather than spray. 785-9000 ..... 8 ounce Spray Bottle  
785-9100 ..... Applicator Bottle Only

**Multi-Teeth Blades**



This 13cm blade is especially good for coping and fine cutting on high performance machines. Reversed pairs of teeth allows cutting on both the forward and backward stroke. Teeth are also spaced to allow sufficient clean-out of the material that has been cut. Blade can be mounted in either direction. The larger the number, the wider and thicker are the blades. Twelve blades per package. Made in Germany.

830-6100	..... #2/0	..... 15 tpi
830-6201	..... #1	..... 15 tpi
830-6203	..... #3	..... 13 tpi
830-6205	..... #5	..... 13 tpi
830-6207	..... #7	..... 10 tpi
830-6209	..... #9	..... 8 tpi
830-6212	..... #12	..... 8 tpi

**Reverse Tooth Blades**



These blades have a number of reverse teeth that produces a splinter free finish on the top of your work, and on the bottom as well. This 13cm long blade is hardened, and great for aggressive fast cutting in hardwoods. The number of reverse teeth varies depending upon the tpi of the blade and is indicated below. The finer tpi have more reverse teeth than the coarser tpi blades. Twelve blades per package. Made in Germany.

830-7000	..... #2/0	..... 10 Reverse Teeth
830-7001	..... #1	..... 7 Reverse Teeth
830-7003	..... #3	..... 7 Reverse Teeth
830-7005	..... #5	..... 7 Reverse Teeth
830-7007	..... #7	..... 7 Reverse Teeth
830-7009	..... #9	..... 6 Reverse Teeth
830-7012	..... #12	..... 6 Reverse Teeth

**Spiral Tooth Blades**



These high quality 13cm long blades are extremely versatile and work extremely well in wood, plastic, and wallboard. The unique spiral tooth design is on all sides of the blade, enabling the blade to cut in all directions! Dimension is the diameter of the blade. Packs of twelve blades. Made in Germany.

830-5003	..... #0	..... 0.64mm
830-5013	..... #1	..... 0.68mm
830-5023	..... #2	..... 0.80mm
830-5033	..... #3	..... 0.88mm
830-5043	..... #4	..... 0.98mm
830-5053	..... #5	..... 1.05mm
830-5063	..... #6	..... 1.15mm

**Safety Sticks**



Use this pair of sticks for control of your work. Counters the lifting tendency for front edge of workpiece. Allows you to place forward and side-way pressure all at once. 825-1100 ..... Safety Sticks

**Push Blocks**

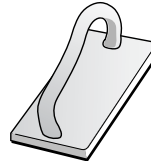

These push blocks should be in every shop that has a table saw, jointer, shaper, and other power tools. The rubber pad on the bottom of the block gives a firm grip on the work, while your hands are kept away from the danger area. Makes many operations safer than they might otherwise be without this tool. 825-1025 ..... Safety Push Blocks 3" x 6"  
825-1050 ..... Safety Push Blocks 2 3/4" x 16"

**Push Stick**

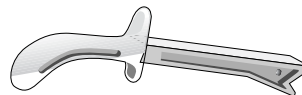

Push stick measures 11" long and has a comfortable grip handle. Keeps your fingers away from cutting edges. 825-1000 ..... Push Stick

**Dado Shims**



Slotted and color coded dado shims make adjusting your dado set a breeze. Set includes four each .020", .010", and .002" shims and two .005" shims. Slots allow you to add or subtract the shims without pulling the dado set entirely off the saw arbor. Arbor size 5/8". 860-5000 ..... Shim Set

**Wooden Feather Board**

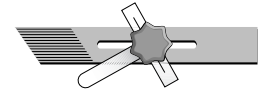

Handy when ripping long pieces of narrow stock. Fits into your miter gauge slot and locks securely. Puts pressure on the work to keep the work where you want it to be. Board is 10 5/8" long, 1 3/4" wide, and 7/16" thick. 825-1425 ..... Wooden Feather Board

**Feather Board**

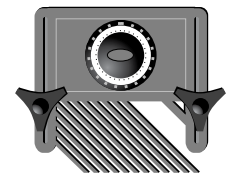

Lock this safety device into a standard mitre slot. Not only will it make your process safer, but it will increase accuracy. Adjustable through four and one-half inches of movement. Overall size is 9/16" thick, 1 3/4" wide, and 10" long. 825-1450 ..... Feather Board

**Fence Hold-Down Feather Board**

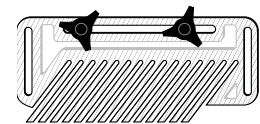

Use the fence hold-down featherboard on table saws, band saws or router tables and keep your hands clear of the tool's cutting action. By attaching the featherboard to a fence, adequate downward pressure is provided to keep the workpiece secure. Adjustments are made via two star knobs with bolts and two slots for screws. Size is 7 3/4" x 3 1/4" x 1/2". 825-6050 ..... Hold-Down

**Tapering Jig**

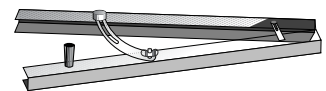

Twenty-four inch aluminum jig is reversible for right or left hand use, and adjusts up to fifteen degrees (three inches per foot). Designed so the jig rides up against your fence while the tapered side of the jig hooks the edge of your piece. 825-1150 ..... Tapering Jig



WOODBURNING — CHECKERING — MISCELLANEOUS

Insulation Cutter



This insulation cutter answers a demand for an easy to use, inexpensive, and effective tool for the cutting of fiberglass insulation, rock wool insulation, foam insulation, and other similar materials. The tool has an extremely sharp wavy edge, straight edge, and marking edge. The hard chrome plated SK2 high carbon steel blade is 6 3/4" long and .03" thick. The blade is attached to an attractively finished hardwood handle and includes a reusable storage pouch. Made in Japan.

740-5000 ..... Insulation Cutter

Automatic Sewing Awl



An excellent tool for sewing leather, canvas, and similar materials. The awl carries a spool of thread on the handle. Hollow handle holds extra curved needle and wrench. Directions included.

160-4000 ..... Automatic Awl
160-4010 ..... Extra Needles
160-4020 ..... Reels of Thread

Millimeters to Inches

Table with 2 columns: Millimeters and Inches. Conversion values from 1 to 60 mm.

Sewing Needles

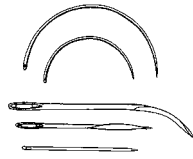

Assortment of professional type needles. Useful in every home! Two curved upholstery needles, one special bent needle, one awning or canvas needle, and one carpet needle.

160-1000 ..... Sewing Needles

Hollow Screw Extractor



Turned counterclockwise in an electric drill, this tool makes easy work of removing broken screws from wood, while leaving a clean hole that can be filled with a dowel or plug. Use the 1/4" model for screws up to #8 and the 5/16" model for #10 screws and larger. Size refers to the finished hole size.

800-3004 ..... 1/4"
800-3005 ..... 5/16"
800-3006 ..... 3/8"

Violin Knife

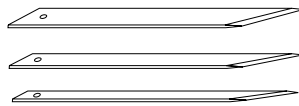

We offer three sizes of chip-carving blades suggested by the late master violin-maker, Hans Weisshaar. These knives are beveled on both sides (not one side like a marking knife) and are sold as blades only, no handles. Hock Tools.

110-8025 ..... 1/4" X 7"
110-8050 ..... 1/2" X 7"
110-8075 ..... 3/4" X 7"

Threaded Inserts

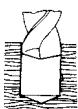

1) Drill appropriate size hole.

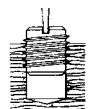

2) Knife thread easily cuts into the wood.

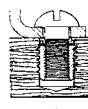
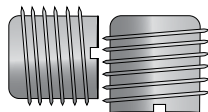

3) You now have metal threads in your wood!

After drilling the proper size hole, use a screwdriver to drive in the knife-thread inserts, after which you have permanent metal threads installed in the wood. Great for knock-down furniture. Available only in packages of twenty-five pieces.

195-5010 ..... 10-24 Pack of twenty-five inserts
195-5020 ..... 1/2" x 20 Pack of twenty-five inserts
195-5030 ..... 3/16" x 18 Pack of twenty-five inserts
195-5040 ..... 3/8" x 16 Pack of twenty-five inserts

Checkering Tools



Skip Line

Bordering Cutter



Triple Cutter



Double Cutter



Spacing Cutter



Layout Cutter



Short Curve

Starter set contains a complete S-1 tool, two regular handles as well as a fine layout cutter, coarse layout cutter, double cutter, spacing cutter, and a wide bordering cutter. The master set contains a fine layout cutter, coarse layout cutter, double cutter, left spacing cutter, right spacing cutter, and S-1 short cutter with a handle for each. (Dem-Bart)

153-4018 ..... Starter Set 18 lines/in
153-5018 ..... Master Set 18 lines/in
153-2500 ..... Checkering Instruction Book

Hollow Punches

Set of nine hollow/belt punches. In tool steel in nominal metric diameters. A very nice round plastic box of small sizes for work on leather and cardboard of all types. Made in France.

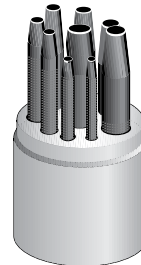

848-1450 ..... Hollow/Belt Punches (Set/9)

A Cabinetmaker's Notebook

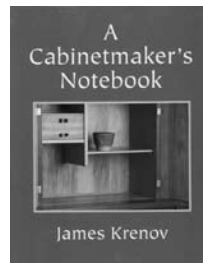

A well known work by Krenov, this is the first in a series of four books written about the art and craft of cabinetmaking. Very good and quite inspirational. You will find yourself opening this book over and over again!

415-1510 ..... A Cabinetmaker's Notebook

Woodburner



This woodburner is the finest available. The tip of the tool is hot enough to burn wood, as the woodburner desires, and yet the handle stays cool. Lightweight, slim design, 64" cord, UL approved. The Dial-Temp provides infinite burning control, and allows the finest "shading". Temperature of 900 to 950 degrees without using the "dial-a-temp."

270-1000 ..... Woodburner with one tip
270-3000 ..... Accessory Stand
270-2000 ..... Dial-a-Temp

- 270-1005 ..... Standard
270-1010 ..... Needle
270-1015 ..... Blank
270-1020 ..... 1/16" Circle
270-1025 ..... 1/8" Circle
270-1030 ..... 3/16" Circle
270-1035 ..... 1/16" Round
270-1040 ..... 1/8" Round
270-1045 ..... 3/16" Round
270-1050 ..... Button Tip
270-1055 ..... Multi Groove Tip #44
270-1060 ..... Multi Groove Tip #56
270-1065 ..... Long Blank Tip
270-1070 ..... Knife Blade Tip
270-1075 ..... Soft Feather Tip
270-1090 ..... Stencil Tip

Not Illustrated





TOOLS FOR THE SHOP AND HOME

Counter Brush



One hundred percent horse hair counter brush for the easiest clean-up of sawdust and shavings. Nine inch brush on a 13<sup>3</sup>/<sub>8</sub>" nicely finished wood block. Helps make cleanup a more enjoyable job. Made in USA.

235-1000 ..... Counter Brush

Giant Dust Pan

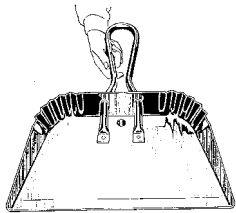

Pick up a shop full of saw dust and wood shavings in one scoop! The lip of this all aluminum pan sits flat against the floor for a no hands sweep up. Oversize 10" x 16" dimensions of this larger dustpan make for a fast clean up. Light weight and rust proof. USA.

142-1000 ..... Dust Pan

Household Dust Pan



For smaller cleanup jobs, or as a general household dust pan, this light in weight, overall 11" x 14" sized dustpan is perfect. USA.

142-2000 ..... Dust Pan

Silica Gel

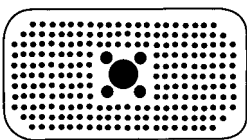

Silica Gel prevents condensation, rust, mildew and corrosion in closed storage areas like your tool box by absorbing humidity. Forty gram size in 4" x 2" x 1/2" aluminum canister protects 3 cubic feet. Granules will last a lifetime— just put in oven when the built-in indicator tells you.

155-1040 ..... 40 gram Silica Gel

Pocket Knife

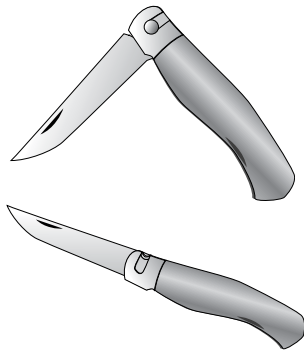

This is a wonderful utility knife with a 3<sup>3</sup>/<sub>8</sub>" quality carbon blade and an overall knife length of eight inches. Available with five different handles: Dyed Beech, White Beech, Boxwood, Olivewood and Ebony. The knife mechanism is stainless steel on all models. The white Beech, Boxwood, Olivewood, and Ebony handles are buffed to a high quality finish. This knife is at home at a picnic, in the shop, on a boat, or anywhere you might need a sharp edge. Made in France.

847-7010 ..... Marjacq Knife - Dyed Beech  
 847-7020 ..... Marjacq Knife - White Beech  
 847-7030 ..... Marjacq Knife - Boxwood  
 847-7040 ..... Marjacq Knife - Olivewood  
 847-7050 ..... Marjacq Knife - Ebony

Knife Sharpener

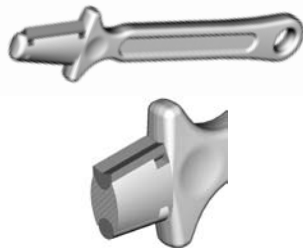

Fitted with a V form insert in solid tungsten carbide on one side, and on the opposite side of the tapered head a second insert, this one round with a diamond ground helical chip-breaker which is used after the V insert to remove any burrs and refine the edge. This second insert also works as a quick touch-up between sharpenings. Excellent for sharpening pocket, shop or kitchen knives whether in stainless or carbon steel. A truly refined and polished edge can be achieved on most any tool. Sharpening tool comes with a very nice soft pouch for storage and protection while not in use. Clearly worded and illustrated instructions are also included with each. Works great on the Marjacq pocket knife. Made in France.

847-6150 ..... Knife Sharpener

Beeswax



Beeswax has many uses in the home and in the shop. Helps lubricate wood to wood joints, dead centers of wood lathes, drive screws more easily. The uses are endless.

870-1000 ..... 1 Ounce Block  
 870-1010 ..... 1lb. Block

Universal Cutter

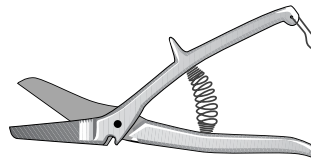

Light universal notched blade cutter and wire cutter. These cut copper, aluminum sheet, leather, carton, paper, and soft steel and soft steel wire (thin dimensions). They have a lovely "retro" form with a built-in hand stop. They have a "notch" above the pivot point which is specially hardened to do wire-cutting, like paper-clips etc. Striations in handle assure good grip. Hot forged. The lower jaw has mini-serrations to prevent the slippage of materials during cut. And though it is made of tool steel it can and does find good use in the kitchen as poultry shears. Just keep it dry after use. Keep one in the shop, one in the kitchen, and another with your garden tools. Made in France.

843-1000 ..... Universal Cutter

Gimlets



No need to find an electrical outlet with a gimlet! These high quality tools are hardened to the end of the flute, and the screw thread is specially annealed to make sure that it is not easily broken. The double spiral flutes are machined, rather than twisted, and will quickly and easily allow wood chips to clear the hole. Keep a set in the house, in the kitchen, and with your garden tools. An inexpensive, traditional, and extremely useful tool! Made in France.

849-3099 ..... Set of Four Gimlets  
 849-3050 ..... 3mm  
 849-3060 ..... 4mm  
 849-3070 ..... 5mm  
 849-3080 ..... 6mm

Sliver Gripper

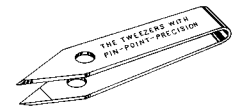

Uncles Bill's "Sliver Gripper" is one of the most important tools for any woodworker. The precise design and construction of these tweezers make them work where others cannot. USA.

300-1000 ..... Sliver Gripper  
 300-2000 ..... Sliver Gripper for key chain

Rare Earth Magnets

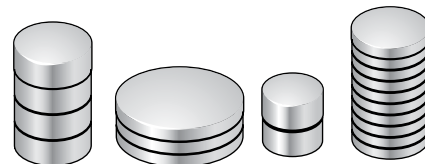

These are very strong magnets which can be used in a tremendous variety of applications in the shop and projects for the home. The only limitation is your imagination. Two applications include tool storage and "invisible" catches.

825-4775 ..... 10 pieces ..... Magnets-10mm x 5mm  
 825-4800 ..... 10 pieces ..... Magnets-8mm x 5mm  
 825-4825 ..... 10 pieces ..... Magnets-10mm x 3mm  
 825-4850 ..... 10 pieces ..... Magnets-9.5mm x 1.5mm  
 825-4875 ..... 10 pieces ..... Magnets-6mm x 3mm  
 825-4900 ..... 6 pieces ..... Magnets-24.5 x 3mm  
 825-4925 ..... 6 pieces ..... Magnets-19mm x 3mm





### Multiple Use Clamp

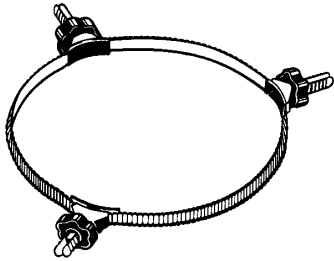

A unique clamp that can be joined in virtually unlimited quantities for larger or more complicated jobs. One clamp will handle 4" diameter, for bigger jobs add more clamps! Packaged two clamps per bag. If a smaller and non-adjustable connection would be useful, there is a splicing coupler available as an accessory.

688-1000 ..... Two Clamps  
688-1500 ..... Extension

### Beeswax Barrier Cream



Developed for people whose work is potentially harmful to their hands. It is waterproof, and protects against other sensitizers such as oil and dirt. It is scented with essential oil of Rosemary and Lavender. It contains "Allantoin".  
870-4000 ..... Beeswax Barrier Cream 8oz

### Two Cherries Baseball Cap



Stylish, unique and a nod to your favorite chisels and carving tools. Fully adjustable, adult-sized cap.

524-7300 ..... Baseball Cap

### French Garden Scissor



More properly called a grape harvesting shear, this fine tool is made in carbon steel. It is exactly as the old scissors were made for harvesting of grapes in many regions of France. Also, often used in the garden on fruit trees and plants for thinning of fruit clusters. It can also be used to serve grapes from the bunch at the table. Probably coming from a design that is several hundred years old, it can also be used for flower cutting. Be certain to keep dry as the carbon steel (part of what makes it a fine tool) can rust.

847-8000 ..... French Garden Scissor

### Japanese Gardening Knife



An indispensable tool! You'll find this to be the one tool labeled, "Must Have". The broad, slightly concave shaped blade can slice into manicured lawns for removing weeds while not leaving a gaping hole. Or it can be used to remove deep roots, small rocks and dig holes for new plants. One edge is serrated and the other is straight but not knife sharp. It has a graduated measuring scale from 25mm to 150mm (slightly over 6"). Plastic handle and plastic scabbard.

725-1000 ..... Gardening Knife

## CLARINGTON FORGE

Made in England

Clarington Forge has been producing the finest forged spades and forks for over two hundred years. Knowing the need for cutting tools of equal quality, they have introduced this fine line of cutting tools for the gardening professional and enthusiast. These are the perfect cutting tools to be used alongside your Clarington Forge digging tools.

### Bypass Pruning Shears



These pruning shears are one of the most popular cutting tools. Their sharp blade and comfortable grip make them ideal for cutting back live or 'green' shoots as well as undergoing everyday pruning tasks. Features Soft Touch handles. Available in two sizes, 15mm and 20mm cutting capacity. The 15mm tool has a smaller grip as well.

G40-1000 ..... Bypass Pruning  
G40-1250 ..... Bypass Pruning w/Small Grip

### Ratchet Pruning Shears



Ideal for cutting back overgrown bushes & foliage. The ratchet mechanism aids the user when cutting through thicker twigs and branches. A very popular pair of pruners. Features a 20mm cutting capacity. Ratchet mechanism allows this maximum cutting capacity to be used with ease! Soft grip.

G40-1500 ..... 20mm

### Anvil Pruning Shears



Anvil pruning shears are the perfect tool you need for cutting back woody or dead growth. The anvil aids the cutting and allows the user to cut through cleanly with ease. Features an anvil cutter and soft grip.

G40-1550 ..... 20mm Cutting Capacity

### Topiary Shears



Topiary Shears with Carbon Blade are ideal for the expert or beginner. Designed with topiary work in mind, this pair of shears is perfect for box work but also work on a bigger scale. The shears are made to provide the perfect resistance in your hands, which make them quick and simple to be used. Features carbon steel blades and soft grip handle.

G40-3000 ..... Topiary Shears

### Folding Pruning Saw



Heat treated, high carbon tool steel blade. Hard-chrome plated for hardness and rust protection. Razor sharp teeth will never need sharpening under normal use. Saw cuts on the pull stroke. Prunes easily up to five inches. For cutting and trimming branches, timber, plastic pipe, and general pruning around the garden. 210mm blade with double locking system for safety.

G40-2000 ..... 9"



**Tested for Strength**



Our spades are regularly sample tested by being repeatedly loaded and bent on a machine. The British Standard dictates that after a load of 150 lbs is put on the end of the handle, held for three minutes and released, the handle should return to within 25mm of it's original position. A Clarington Forge spade typically returns to within 2 to 3mm! Not only this but our spades take a loading well over 200 lbs without permanent damage!

**Solid Forged for Exceptional Strength**

Heads and sockets are forged from a single piece of Manganese Steel, then securely attached to the shaft. The absence of welding eliminates points of weakness, resulting in a durable longer lasting tool

**The Strongest Socket**

We recognize that where the shaft joins the socket is potentially the weakest point of the spade. We bury the shaft deep inside the socket, increasing durability and resilience of the tool's inherent strength, ensuring it is able to withstand the toughest of use.

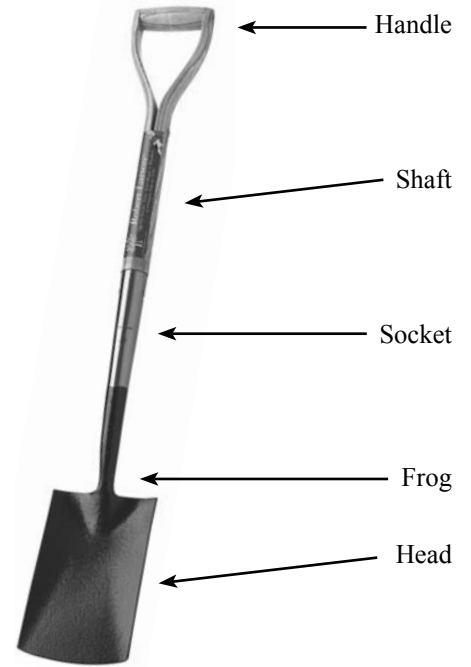

**Digging Spade**



Designed for digging in unprepared ground in preparation for the planting of new plants, seeds and vegetables. Solid Forged for strength. The basic spade is the same on both lengths of the tool. The longer 32" handled tool also has treads welded to the top of the head where your foot steps. Some gardeners prefer the feel of this "tread".

G30-1250 ..... Forged 28" Ash Handle  
 G30-1275 ..... Forged Treaded 32" Handle

**Shrubbery Spade**



Ideal for use in confined spaces, the lightweight design is an excellent alternative to the heavier models. Great for the smaller user or when needing to dig in tight areas. Solid Forged for strength.

G30-1750 ..... Solid Forged

**Border Spade**



The narrow blade makes this the perfect alternative to the heavier garden spade, particularly when working in confined spaces. Ideal for digging between borders and existing plants. Solid Forged for strength.

G30-1500 ..... 9 x 5.5" - 28" Ash Handle

**Rabbiting Spade**



This tool was originally used by farmers to dig out rabbit burrows. It is ideal for digging, especially around existing plantings. Ideal for digging in the garden around existing plantings, due to its narrow blade. Solid Forged for strength.

G30-1900 ..... with "T" Ash Handle



**Digging Fork**



The ideal tool for aerating and turning soil, digging compacted soil, breaking down lumps and levelling ground. Solid Forged for strength.

- G30-2250 ..... Solid Forged 28" Ash Handle
- G30-2275 ..... Solid Forged 32" Ash Handle

**Border Fork**



For maintaining flower beds and borders, digging out weeds, lifting plants and forking in manure where space is tight. Solid Forged for strength.

- G30-2500 ..... 9 x 5.5" - 28" Ash Handle

**Shrubbery Fork**



The partner tool to the Shrubbery Spade, again ideal for working in confined spaces such as borders. Solid Forged for strength.

- G30-2750 ..... Solid Forged



Fine workmanship at the factory - Wigan, UK.

**Wizard and Merlin Rakes**



Soft rubber fingers cause no surface damage to bowling greens, golf greens, etc. Sweeps uneven and hard surfaces such as patios, shingle and decking. Also good for raking borders without disturbing established plants. Choose between the 20" Wizard or the 10" Merlin rakes, both with 54" ash handles.

- G30-3000 ..... 20" with 54" Ash Handle
- G30-3050 ..... 10" with 54" Ash Handle
- G30-9950 ..... Replacement Tines Only for 20" Wizard
- G30-9975 ..... Replacement Tines Only for 10" Wizard

**Garden Rake**



The shape of the teeth means the head will glide effortlessly, without dragging or snagging. Draws stones & debris towards you and breaks down lumps. Excellent for final soil preparation and tamping raked uneven soil.

- G30-3200 ..... 12" wide - 54" Ash Handle

**Springbok Rake**



The most popular lawn rake, used for scarifying lawns, removing unwanted growth, helping surface aeration and generally improving the quality of the lawn.

- G30-3100 ..... with 20 tines



Today



Yesterday



Yesterday



Today



**Dutch Hoe**



With an angled blade and front cutting edge, this is the ideal tool to keep weeds at bay in the Summer. Perfect for use in between seedlings plants and shrubs.

G30-3500 ..... with 126mm Blade

**Clarice Hoe**



A miniature hoe for delicate work between plants & flowers in confined spaces. Particularly beneficial when working in rockeries.

G30-3600 ..... 3" with 54" Handle



Powder coating provides a tough finish.

**Edging Knife**



Designed to cut cleanly and easily into turf for a perfect edge. Ash T Handle. Adds the finishing touch to any lawn where it meets borders, paths and patios.

G30-3800 ..... with T Ash Handle



**Bulb Planter**

The ideal tool for cutting a clean cone quickly and easily, even in hard soils. Removes the soil, ready to plant the bulb. Solid Forged for strength.

G30-4000 ..... 3" diameter 5" deep

**Riddle**



Removes large lumps and stones to provide perfect potting soil.

G30-5500 ..14" diameter 3" depth - 3/8 Mesh

**Hand Trowel**



A tanged trowel, ideal for planting out bulbs & seedlings & digging out weeds with minimal disturbance. Carbon steel epoxy coated heads reduce soil adhesion.

G30-6250 ..... w/Tanged handle 126mm

**Transplanting Trowel**



Specifically designed to plant bulbs and seedlings with the minimum of effort. The deep dish curve carves out round holes while leaving neighbouring plants undisturbed. Varnished handle.

G30-6500 ..... 5" Blade + 5" Handle

**Dibbler**



The ideal tool for making holes for roots. Use when planting seedlings or root balls. Ash T handle ensures comfort and grip.

G30-7000 ..... 10" Overall

**Hand Fork**



For working the top 6" of the bed, easily removing perennial weeds by the root. Carbon steel epoxy coated heads reduce soil adhesion.

G30-7250 ..... w/Tanged handle 126mm

**Daisy Grubber**



A basic yet essential tool for removing weeds from lawns without damaging the surrounding grass. Carbon steel epoxy coated heads reduce soil adhesion.

G30-7500 ..... Daisy Grubber



**Replacement Handles**

G30-9910 ..... 28 x 1.5 Barrel T Handle  
 G30-9920 ..... 28 x 1.5 Split YD Handle  
 G30-9925 ..... 32 x 1.5 Split YD Handle  
 G30-9930 ..... 54 x 1.25 Rank Handle  
 G30-9940 ..... 50 x 1.25 Rank Handle





BOOKS

Carving

Carving Facial Expressions

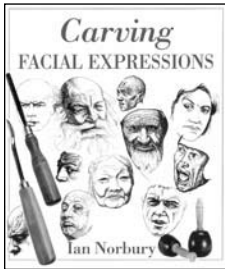

In this book, master carver, Ian Norbury, provides a detailed guide for all craftsmen to discover the art of creating facial expressions in woodcarving.

415-1400 ..... Carving Facial Expressions

How to Carve Wood

Covers the full range of carving including architectural, lettering, relief, wildlife carving, chip carving and more.

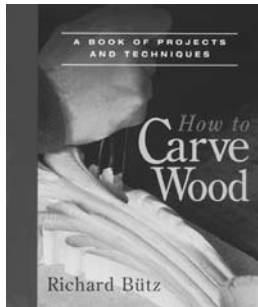

Carving for Kids

Woodcarving is a hobby that can be practiced from young childhood all the way into old age.

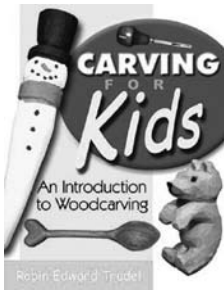

415-1770 ..... Carving for Kids

The Art of Whittling



One of the earliest guides to traditional whittling, this reprint of a 1930s classic preserves all of the original projects and text.

415-1740 ..... The Art of Whittling

Woodturning

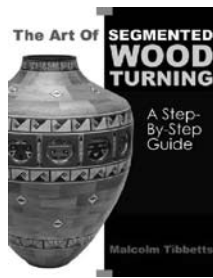

The Art of Segmented Wood Turning

The definitive text on segmented turning. Tibbetts discusses various types of construction, staved, and ring design as well as the difference between inlaid and segmented lamination.

415-1660 ..... Art of Segmented Wood Turning



All Screwed Up - Chased Threads

John Berkeley, well-known turner and teacher, shows you how to hand chase threads in wood, then use the technique in twenty projects to produce clever puzzles and boxes that combine beauty with a brain-teasing twist.

415-1650 ..... All Screwed Up

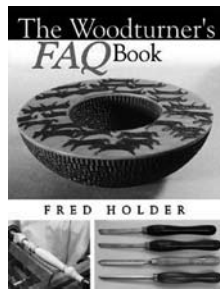

The Woodturners FAQ Book

Aimed at beginning turners, this woodturning primer covers all the basics needed to get started, such as type of lathe, tools and chucks needed, which accessories are handy to have, how to sharpen, differences in various grinding systems, where to obtain wood, and which wood to use.

415-1750 ..... The Woodturners FAQ Book

Joinery

The Complete Dovetail

The dovetail joint is the signature of fine cabinetmaking, and the craft of making it reached its high point in the British Arts & Crafts tradition.

410-1090 ..... The Complete Dovetail

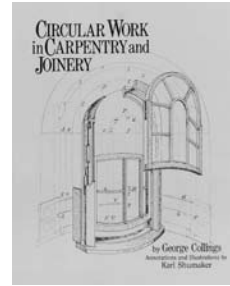

Circular Work In Carpentry and Joinery

A practical guide on circular work of single and double curvature. This is a new edition of the 5th London edition of 1911.

Essential for the carpenter and joiner.

415-1180 ..... Circular Work In Carpentry And Joinery

Hand Tools

Japanese Woodworking Tools

Odate was trained in Japan. In this book he covers the history and use of each tool. Planes, saws, chisels, sharpening stones, etc. The philosophy and techniques of Japan's masters are dealt with.

415-1390 ..... Japanese Woodworking Tools

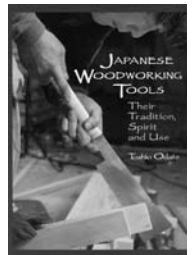

Tool Sharpening

The Complete Guide to Sharpening

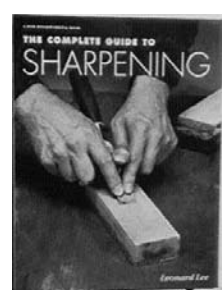

This is the definitive tool-sharpening book. Lee covers both the practical and technical information needed to sharpen tools quickly and efficiently.

415-1620 ..... The Complete Guide to Sharpening

Sharpening with Waterstones

Anyone can learn how to sharpen every kind of woodworking tool, with a minimum of equipment and fuss.

410-1060 ..... Sharpening with Waterstones

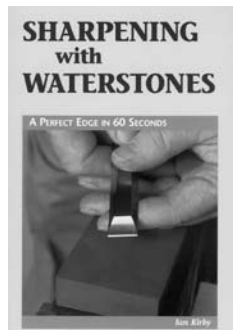



## Power Tools

## Shaper Handbook



Hundreds of techniques are carefully explained in step by step photo-filled detail. Cliffe discusses freehand shaping, jigs and fixtures, and cutting stick joinery. Maintenance, tune-ups and trouble-shooting are covered as well as how to purchase the best shaper for your needs. A complete work on this valuable and versatile machine.

415-1720 .....Shaper Handbook

## The Accurate Table Saw

The only table saw handbook to take a close and safe look at all common woodworking operations. Includes safe procedures for all four things the saw does: ripping, crosscutting, sawing sheet materials, and shaping. With many jigs and joint-making techniques, this book by Ian Kirby is a real value.

410-1070 .....The Accurate Table Saw



## Furniture and Design

## Illustrated Guide to Cabinet Door &amp; Drawers



Your complete how-to reference! Virtually every door and drawer variation that a cabinetmaker is likely to encounter is addressed and explained in this comprehensive guide. Designed to provide tips for both the professional woodworker and the hobbyist. Covers construction of all types of cabinet doors and drawers, extensive, full color gallery of door and drawer styles, extensive coverage of

door and drawer hardware and installation, pocket doors, coopered doors, edge banding, veneer work, metal drawers, and much more.

415-1670 .....Illustrated Guide to Cabinet Door & Drawers

## The Impractical Cabinetmaker

This was the final book in Krenov's trilogy. It is an in depth, personal look at the "do's and don't's" of creating fine furniture. This is both an educational and philosophical treatise. Cabinetmakers of all levels will be inspired by Krenov's understanding of the craft.

415-1490 .....The Impractical Cabinetmaker

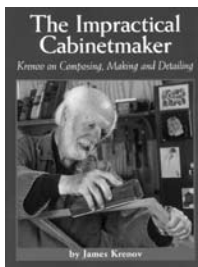

## A Cabinetmaker's Notebook

A well known work by Krenov, this is the first in a series of four books written about the art and craft of cabinetmaking. Very good and quite inspirational. You will find yourself opening this book over and over again!

415-1510 .....A Cabinetmaker's Notebook

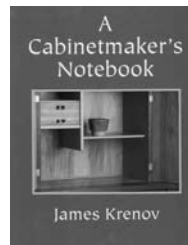

## Furniture Of Gustav Stickley

Stickley was one of the major figures in the Craftsman movement. This is a re-publication of the best discussion of his work and provides detailed drawings and step by step instructions for the reproduction of a number of Craftsman pieces.

415-1360 .....Furniture Of Gustav Stickley

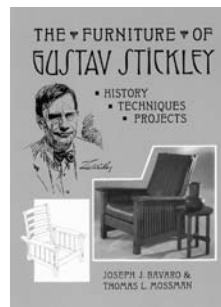

## Making Shoji

Shoji are the lovely sliding panels made of wood and rice paper that form walls and room dividers in the traditional Japanese house. This is the first and only book written by a traditionally apprenticed tategushi, or maker of sliding doors. Detailed information is presented on how to construct shoji for the home. Projects include the common shoji, the transom, and the gakubuchi shoji and toko garasu shoji which have glass panels. Also included is the innovative garasudo, a sliding glass door.

415-1450 .....Making Shoji

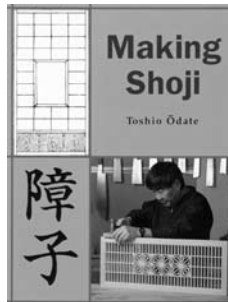

## Arts And Crafts Furniture: Projects

Fifteen projects for the woodworker. These projects represent the work of not only the most famous members of the movement but also of such designers as Oscar Onken and Charles Limbert, whose works are not commonly presented in other woodworking project books. Includes step-by-step instructions, joinery, measured drawings, fumed oak process, and bills of material. Projects include a print stand by Frank Lloyd Wright, book stand by Oscar Onken, Book Case by Limbert, a writing desk by G. Stickley and more.

415-1460 .....Arts And Crafts Furniture: Projects



## Building Cabinet Doors And Drawers

Doors and drawers are the working parts of cabinets, and they're also what people see. That's why doors and drawers are so important-how they're designed and made determines how the cabinet looks and functions. Novice woodworkers often find the design of a door or drawer to be intimidating. Proulx offers step-by-step instructions on a wide variety of doors and drawers. Included are pull-outs for kitchens, slab doors, frame-and-panel, arched frame-and-panel, cope-and-stick, glass panel, tambour doors, and various types of drawers.

415-1520 .....Building Cabinet Doors And Drawers

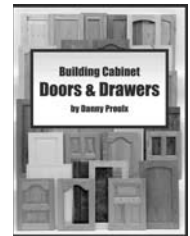

## Home Construction and Renovation

## Making Mantels



No woodworking project is more gratifying than making a beautiful fireplace mantel. Plentiful examples and plans cover a broad range of possibilities for the craftsperson to consider. This is aimed at both the professional and the home craftsman. Getts, a professional cabinetmaker and builder, covers essential information peculiar to mantel, fireproof materials, safety considerations, and building codes, as well as a whole host of style elements.

415-1700 .....Making Mantels

## General Woodworking Books

## New Wood Puzzle Designs

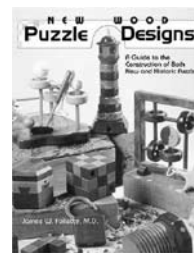

Twelve puzzles of four different basic types are described in this guide, along with the tools and techniques needed to make them. There is expert advice on the woods, glues and finishes that will give the best results. These puzzles are beautiful and intriguing objects in their own right, and offer woodworkers a delightful means of sharpening their skills and astonishing their friends.

415-1690 .....New Wood Puzzle Designs

## The Complete Manual of Wood Bending



Bending wood is an important facet of woodworking and can be seen in many different applications including bentwood chairs, laminated handrails, and milled window components. Lon Schleining provides step-by-step instruction on each of three basic methods of producing curved work, laminate bending, steam-bending, and milling. This is a complete course in bending. The author is a professional stairbuilder and college level instructor.

415-1710 .....Complete Manual of Wood Bending



BOOKS

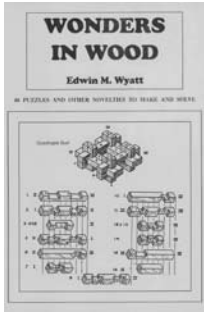

Wonders In Wood

This is the sequel to the author's hugely popular "Puzzles in Wood". In this collection some 46 puzzles are just waiting to be made up and solved. They range from the simple to quite challenging pieces for those craftsmen who like to take pride in having their work fit snugly and accurately. The three dimension jigsaw puzzle makes a great variation on the conventional jigsaw. Try squaring triangles or making a triple dovetail puzzle, or an eighteen piece double-cross. Happy puzzling.

415-1430.....Wonders In Wood

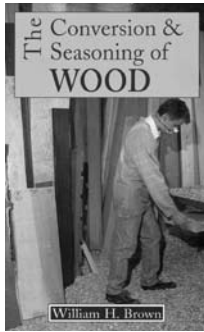

The Conversion And Seasoning Of Wood

Covers the aspects of timber conversion from the most advantageous methods of cutting to produce the highest yield, to various methods of seasoning including air drying, kiln drying, dehumidification, etc. This work is directed towards the smaller timber merchant and land-owner.

415-1500.....The Conversion And Seasoning Of Wood

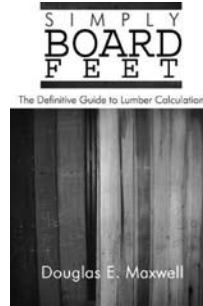

Simply Board Feet

Quick reference tables that provide the board foot measurements for lumber from one to more than 25 inches wide, one to 20 feet long, and one to four inches thick. Whether you need to figure inventory going out or coming in, buying to a cut list, or figuring for an invoice, this is a very helpful book and a remarkable time-saver.

415-1730.....Simply Board Feet

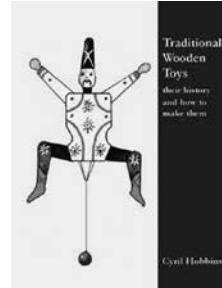

Traditional Wooden Toys

This book spans the generations, recalling the simplicity and pleasure of playthings created with imagination, by hand, from durable materials that harken back centuries. The book will inspire designers, parents, and children to create amazing wooden playthings.

415-1760.....Traditional Wooden Toys

NOTES



## INDEX

<hr/> <b>A</b> <hr/>		Dust Pan.....56	<hr/> <b>L</b> <hr/>		Scorp.....50	
Adze.....50	Dutch Hoe.....59			Scrapers.....33	Self-Adhesive Rule.....22	
Anant Planes.....34-35	<hr/> <b>F</b> <hr/>				Shavehook Set.....48	
Aprons.....3, 4			<hr/> <b>M</b> <hr/>		Shelf Pin Drill Jig.....29	
Awls.....24					Shrubbery Fork.....58	
<hr/> <b>B</b> <hr/>		Feather Board.....54			Sjöbergs Workbenches.....18, 19	
Bees Wax.....56	Files.....45	Folding Rules.....22			Skew Chisels.....2	
Bees Wax Polish.....48	Forstner Bits.....25	<hr/> <b>G</b> <hr/>		Slip Stones.....30	Small Carving Tools.....9	
Bench Dogs.....42					Spokeshaves.....37	
Block Plane Holster.....4	Garden Tools.....57-60	Gimlets.....28			Straight Edge Chisels.....2	
Books.....61, 62	Glue Injector.....49	Gouges.....2	<hr/> <b>H</b> <hr/>		Swan Neck Mortise Chisel.....2	
Bostik Lubricants.....54	<hr/> <b>H</b> <hr/>				<hr/> <b>T</b> <hr/>	
Boxed Chisel Sets.....1	Hammer, Warrington.....47	Hand Drills.....28	<hr/> <b>P</b> <hr/>		Threaded Inserts.....55	
Brad Point Drills.....26	Hand Fork.....59	Hand Saws.....40			Timber Framing Chisel.....3	
Burnishers.....33	Hide Glue.....49	High Speed Steel Turning Tools.....14-17			Tool Cases.....3	
Butt Chisels.....2	Hock Irons.....35	Hollow Mortise Chisel.....53			Tool Roll (Leather).....3	
<hr/> <b>C</b> <hr/>		Honing Guide.....31			Top-Cote.....54	
Camilia Oil.....54	Honing Oil.....30	<hr/> <b>I</b> <hr/>		Transfer Scribe.....49	Transplanting Trowel.....59	
Carving Tool Rolls.....4	<hr/> <b>I</b> <hr/>				Trimming Knives.....51	
Carving Tool Sets.....8-12	Inshave.....50	<hr/> <b>J</b> <hr/>		Try Squares.....20	Turning Tool Rolls.....4	
Cat's Paw.....47	<hr/> <b>J</b> <hr/>				Turning Tools, High Speed Steel.....14-17	
Center Finder.....23	J Roller.....51	<hr/> <b>K</b> <hr/>		Two Cherries Carving Tools.....6-11	<hr/> <b>V</b> <hr/>	
Chisel Edge Guards.....2, 3	Japanese Oire Nomi Chisels.....3					
Chisel Rolls.....3, 4	Japanese Saw Cases.....4			<hr/> <b>W</b> <hr/>		
Chisel Sets.....1-3	Japanese Saws.....39	<hr/> <b>R</b> <hr/>		Warrington Hammer.....47		
Chisels.....1-3	<hr/> <b>R</b> <hr/>				Water Stones.....33	
Combination Square Set.....21	Rake.....59			Whittler's Apron.....3		
Compasses, Dividers and Calipers.....23	Rare Earth Magnets.....56			Whittling Kits.....12		
Contour Gauge.....24	Rasps.....45, 46			Wizard Rake.....58		
Corner Chisel.....2, 53	Registered Chisels.....3	<hr/> <b>S</b> <hr/>		Wooden Planes.....38		
Countersink Drills.....27	Replacement Handles for Chisels.....2			Workbenches, Sjöbergs.....19		
Cranked Paring Chisel.....3	Riffler Rasp Sets.....46					
Curved Bevel Edge Chisel.....2	<hr/> <b>S</b> <hr/>					
Curved Gouge.....2	Salad Bowl Finish.....48					
<hr/> <b>D</b> <hr/>		Sanding Block.....44				
Digging Fork.....58	Sanding Drums.....44					
Digging Spade.....58	Saws, Hand.....40					
Drawknives.....50	Saws, Japanese.....39					
Dry-Cote.....54	Scissors, French Garden.....57					

## NOTES